

MHI
Copy 3

FM 24-20

DEPARTMENT OF THE ARMY FIELD MANUAL

**FIELD-WIRE
TECHNIQUES**
FOR HISTORICAL USE ONLY



DEPARTMENT OF THE ARMY

•

MAY 1956

FIELD MANUAL }
No. 24-20 }DEPARTMENT OF THE ARMY
WASHINGTON 25, D. C., 17 May 1956**FIELD-WIRE TECHNIQUES**

	Paragraph	Page
CHAPTER 1. INTRODUCTION.....	1-4	3
2. WIRE WD-1/TT		
Section I. Introduction.....	5, 6	5
II. Splicing.....	7-11	6
III. Field-wire ties.....	12-22	23
CHAPTER 3. FIELD CABLES.....	23-26	39
4. WIRE-LAYING AND WIRE-RECOVERY EQUIPMENTS.....	27-35	52
5. POLE AND TREE CLIMBING		
Section I. Climbing equipment.....	36-41	67
II. Pole climbing.....	42-48	77
III. Tree climbing.....	49, 50	88
CHAPTER 6. FIELD-WIRE LINE CON- STRUCTION		
Section I. Planning.....	51-57	90
II. Orders and records.....	58-62	96
III. Field-wire construction tech- niques.....	63-72	102
IV. Construction under unusual conditions.....	73-77	118
CHAPTER 7. MAINTENANCE OF FIELD - WIRE SYSTEMS.....	78-84	122
8. CHARACTERISTICS OF COMMUNICATION EQUIPMENT		
Section I. Introduction.....	85, 86	132
II. Field telephones.....	87-92	133

*This manual supersedes FM 24-20, 4 October 1948.

	Paragraph	Page
CHAPTER 8. CHARACTERISTICS OF COMMUNICATION EQUIPMENT—Con.		
Section III. Manual telephone switchboards.....	93-96	140
IV. Field teletypewriters.....	97-99	147
V. Telephone repeaters.....	100-103	151
VI. Telegraph-Telephone Terminal AN/TCC-14.....	104-108	156
VII. Terminals.....	109-111	162
VIII. Repeating coils.....	112-114	165
IX. Test equipment.....	115-119	174
CHAPTER 9. TELEPHONE SWITCHBOARD OPERATION...	120-124	183
APPENDIX I. REFERENCES.....		187
II. SPECIAL SYMBOLS USED IN WIRE DIAGRAMS AND MAPS.....		192
III. PHONETIC ALPHABET.....		198
IV. TELEPHONE DIRECTORY.....		200
GLOSSARY OF WIRE COMMUNICATION TERMS.....		203
INDEX.....		211

CHAPTER 1

INTRODUCTION

1. Purpose and Scope

a. This manual is a guide for personnel concerned with the installation and maintenance of field-wire communication systems.

b. This manual covers field-wire techniques, field cable, and the various types of communication equipment commonly used in tactical wire systems.

2. References

Publications, training films, and other reference material pertaining to the subjects within the scope of the manual are listed in appendix I. Nomenclature followed by () is used when reference is made to all models of the item of equipment.

3. Field-Wire Systems

Field-wire communication systems are used to provide tactical units with telephone, teletypewriter, and facsimile services. Field wire is used also in the local communication systems of rear-area elements when time or other considerations prohibit the installation of more permanent facilities. Field-wire systems are designed specifically for tactical operations. The equipments are rugged, can be installed and removed rapidly, and are comparatively easy to maintain. A typical field-wire system includes field-wire lines, field telephones, teletypewriters, switchboards, and terminal strips.

4. Responsibility

Every commander is responsible for the installation, operation, and maintenance of a signal communication system within his own unit. Every unit is responsible for installing and maintaining wire communications from its own headquarters to the headquarters of its next subordinate units.

CHAPTER 2

WIRE WD-1/TT

Section I. INTRODUCTION

5. General

This chapter prescribes the standard practices used in the splicing and tying of Wire WD-1/TT, more commonly known as field wire.

6. Technical Characteristics of Wire WD-1/TT

Wire WD-1/TT (fig. 1) consists of two twisted, individually insulated conductors having the following characteristics:

Gage.....	23 AWG.
Number of strands in each conductor.	Four tinned-copper strands and three galvanized-steel strands.
Insulation.....	Each conductor has an inner insulation of polyethylene and an outer insulation (jacket) of nylon.
Tensile strength.....	Approximately 100 pounds.
Weight.....	48 pounds per mile.
Dc resistance.....	220 ohms per mile.
Talking range.....	Approximately 18 miles under dry conditions, or 12 miles under wet conditions.
Signal loss per mile at 1,000 cycles per second.	Approximately 1.6 decibels under dry conditions, or 2.5 decibels under wet conditions.

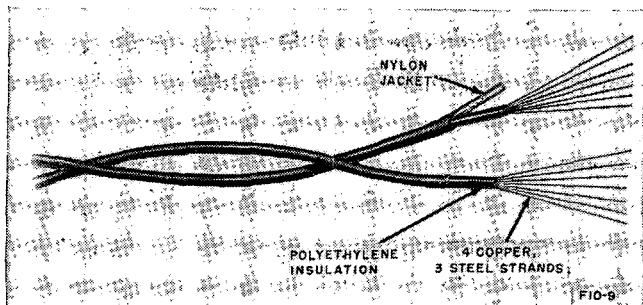

Figure 1. Wire WD-1/TT.

Section II. SPLICING

7. General

a. Splicing. Splicing is a method of joining the conductors of wire lines to maintain electrical continuity. Splices in field wire are vulnerable points in the circuit and must be made properly. A poorly made splice creates unnecessary transmission loss, increases noise, and generally impairs the quality of the circuit. A splice should have the same tensile strength, electrical conductivity, flexibility, insulation resistance, and protection against weathering and abrasion as the unspliced portion of the wire.

b. Tools. The basic equipment and materials required to make a field-wire splice are Tool Equipment TE-33 (fig. 2) and insulating tapes. A small gage, soft-drawn copper wire known as seizing wire should be used to improve the splice mechanically and electrically. (Seizing wire may also be obtained from the copper conductors in a piece of field wire.)

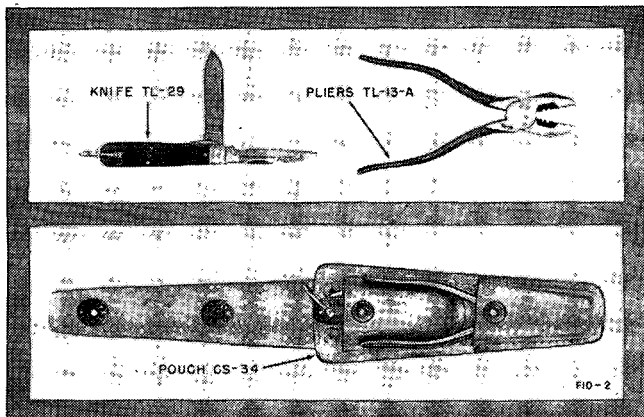

Figure 2. Tool equipment TE-33.

8. Standard Field-Wire Splice

a. Steps in Making Splice. The standard field-wire splice (fig. 3) consists of four essential steps:

- (1) Preparing the wire by staggering the length (*b* below) and removing the insulation of each conductor (*c* below).
- (2) Tying a square knot to retain the tensile strength of the conductors (*d* below).
- (3) Seizing the square knot to provide good electrical conductivity (*e* below).
- (4) Taping the splice to electrically insulate and protect the conductors against abrasion and weather (*f* below).

b. Staggering. The splices in the two conductors of a wire pair are staggered to prevent excessive bulk and to eliminate the possibility of electrical contact between the two conductors. To stagger the conductors of a field-wire pair:

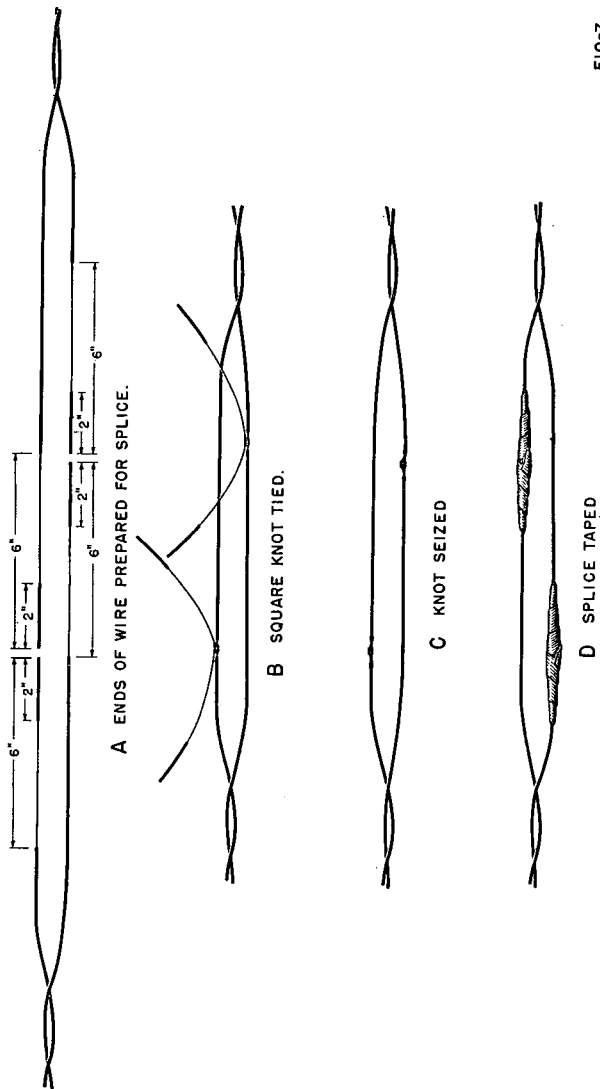

Figure 3. Four steps in making standard field-wire splice.

- (1) Snip off the ends of the pair of wires to insure that both conductors are of equal length.
- (2) Cut one conductor of each pair 6 inches (or one plier's length) from the end (fig. 4).

This uniform stagger is necessary to insure equal tension on both conductors after the splice is completed.

c. Removing Insulation. Both the outer jacket and the inner insulation must be removed to bare the conductors for splicing. Remove the insulation as follows:

- (1) Use Knife TL-29 and score the nylon jacket of the conductor at a point 6 inches from the end (fig. 5).
- (2) Cut and remove about one-half inch of the nylon jacket beyond the score to expose the inner insulation. The exposed one-half inch portion of the inner insulation will provide a good adhesive surface for the insulating tape.
- (3) Remove 6 inches of both nylon jacket and inner insulation, 2 inches at a time with the cutting edge of Pliers TL-13-A.
- (4) Pull the third 2-inch section of the insulation only to the end of the conductor. This keeps the wire strands together during the next step of the splice.
- (5) Scrape the strands carefully with the screw driver blade of Knife TL-29 if they are not clean.

d. Tying Square Knot. Bring together the end of the long conductor of one pair and the end of

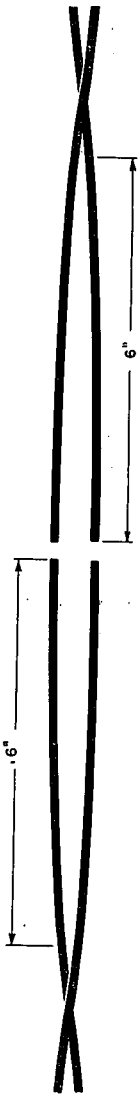

A MEASURE 6 INCHES FROM END OF ONE CONDUCTOR OF EACH PAIR.



B CUT 6 INCHES FROM ONE CONDUCTOR OF EACH PAIR.

Figure 4. Conductors staggered for splicing.

FIG-8

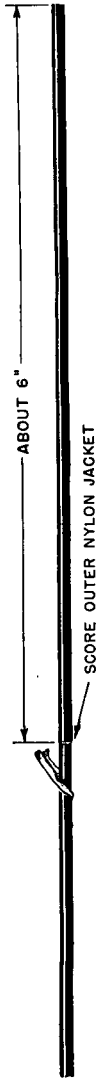

A EXPOSE ABOUT 1/2 INCH OF INNER INSULATION.



B REMOVE FIRST 2-INCH PORTION OF JACKET AND INSULATION.



C REMOVE SECOND 2-INCH PORTION OF JACKET AND INSULATION.



D PULL THIRD 2-INCH PORTION OF JACKET AND INSULATION TO END OF CONDUCTOR.

Figure 5. Removing insulation from field-wire conductor.

FIG-10

the short conductor of the other pair. Twist conductor 1 over and under conductor 2 to form the first loop (A, fig. 6). Again twist conductor 1 over conductor 2 to form the second loop of the square knot (B, fig. 6). Pull the knot tight, but leave about $\frac{1}{4}$ -inch space between the knot and the insulation (B, fig. 6).

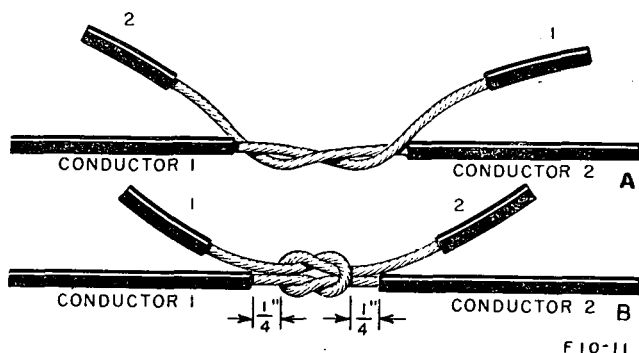

Figure 6. Tying square knot in field wire.

e. *Seizing Splice.*

- (1) *Without seizing wire.* When seizing wire is not available, use the copper strands of the conductor to seize the square knot. After the knot has been tied and pulled tight, remove the third 2-inch section of the insulation and separate the steel strands from the copper strands (A, fig. 7). (Copper strands will stay bent when flexed.) Cut the steel strands flush with the ends of the insulation (B, fig. 7). Cross the left hand end of the copper strands over the

crest of the square knot (C, fig. 7). Wrap several tight turns over the bared portion of the right hand conductor. Continue wrapping until 2 turns have been taken on the exposed inner insulation. Cut off the excess ends of the copper strands. Repeat the seizing operation with the right hand end of the copper strands; again cross over the crest of the square knot and wrap 2 turns on the exposed inner insulation of the left hand conductor.

- (2) *With seizing wire.* When seizing wire is available, insert a 6- to 8-inch piece of seizing wire through the center of the square knot, and tighten the knot (A, fig. 8). Bend the seizing wire at its center. Use half of the wire for wrapping to the left and the other half for wrapping to the right. Take several close turns with the seizing wire, both to the left and to the right, to bind the square knot (B, fig. 8). Cut off the excess ends of the conductors flush with the insulation. Continue the seizing wire wrap, both to the left and to the right of the square knot, until 2 turns are taken on the inner insulation. Cut off the ends of the seizing wire and press the ends down into the insulation (C, fig. 8).

f. Taping Splice. The three types of insulating tapes used on field-wire splices are: Friction Tape TL-83, Rubber Tape TL-192, and Electrical Insulation Tapes TL-600/U and TL-636/U (poly-

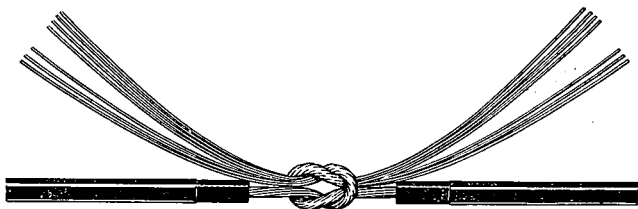

A WIRE STRANDS FANNED OUT AND SEPARATED.

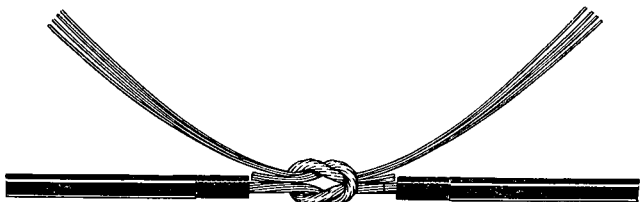

B STEEL STRANDS CUT FLUSH WITH THE INNER INSULATION.

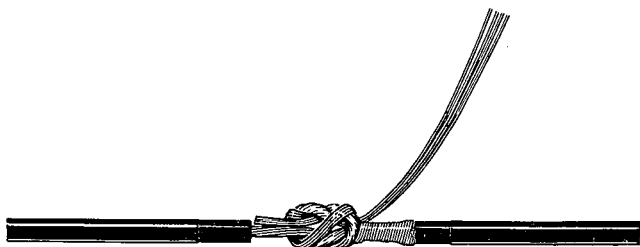

C KNOT SEIZED WITH LEFT HAND COPPER STRANDS.



D KNOT COMPLETELY SEIZED.

FIG-14

Figure 7. Square knot without seizing wire.

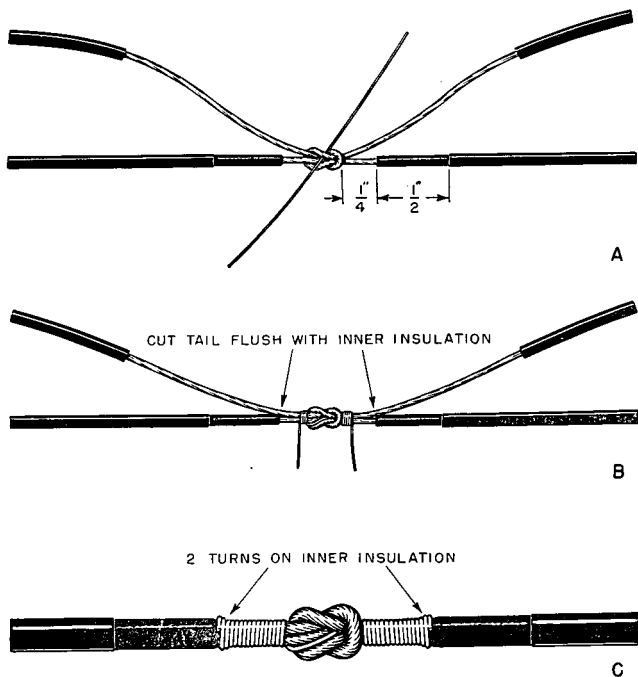

FIG-6

Figure 8. Square knot with seizing wire.

ethylene). Taping a splice is done in either of two ways, depending on the specific tapes used.

- (1) *Use of rubber tape and friction tape.* Remove the backing from the rubber tape and start taping at the center of the splice, working either to the left or right of the knot until one-half inch of the exposed inner insulation is covered. Work the rubber tape back again over the knot until the

tape covers one-half inch of the exposed insulation at the other side. Finally work the tape back again until it ends at the center of the splice (A, fig. 9). Stretch the rubber tape considerably during this wrapping process to obtain a close adhesion. Press each end of the splice to make it waterproof. Wrap two layers of friction tape in the same manner over the rubber tape.

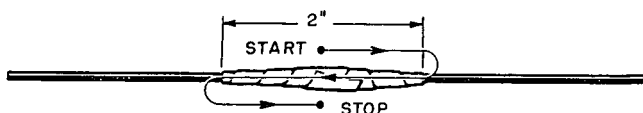

A RUBBER TAPE APPLIED, SHOWING DIRECTION OF WRAPPING.

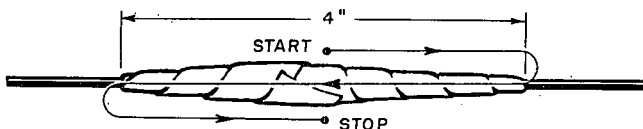

B FRICTION TAPE APPLIED, SHOWING DIRECTION OF WRAPPING.

F10-15

Figure 9. Taping splice with rubber and friction tape.

Extend the friction tape about 1 inch beyond the rubber tape (B, fig. 9). Roll the entire taped splice in the hands to seal the edges of the tape.

- (2) *Use of electrical insulation tape and friction tape.* Electrical Insulation Tapes TL-600/U and TL-636/U are used on field-wire

splices in low-temperature areas. Remove the backing and stretch the electrical insulation tape to activate its self-bonding properties. Start taping at the center of the splice (A, fig. 10). Use a steady pull and tape about 11½ inches beyond the insulation at one end. Work the tape back again over the knot to about 11½ inches beyond the insulation on the opposite side. Finally, work the tape back again to the center of the splice. Wrap one layer of friction tape. Start at either end about one-half inch beyond the electrical insulation tape. Continue the taping to a point about one-half inch beyond the electrical insulation tape on the opposite end (B, fig. 10).

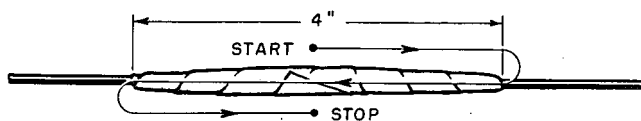

A ELECTRICAL INSULATION TAPE APPLIED, SHOWING DIRECTION OF WRAPPING.

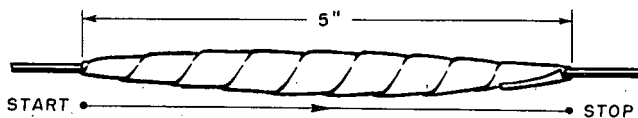

B FRICTION TAPE APPLIED, SHOWING DIRECTION OF WRAPPING.

FIO-16

Figure 10. Applying electrical insulation tape and friction tape.

9. Combination Splice

The combination splice (fig. 11) is used to splice a stranded-conductor insulated wire to a solid-conductor insulated wire. The splice is made as follows:

a. Remove 6 inches of insulation from the end of each wire and scrape the wire clean.

b. Tie an overhand knot (first half of a square knot) in the stranded wire within one-half inch of the insulation.

c. Slip the knotted wire over the solid wire to within one-half inch of the insulation (A, fig. 11).

d. Wrap the stranded wire around the solid conductor up to the insulation (B, fig. 11). Cut off the excess stranded wire.

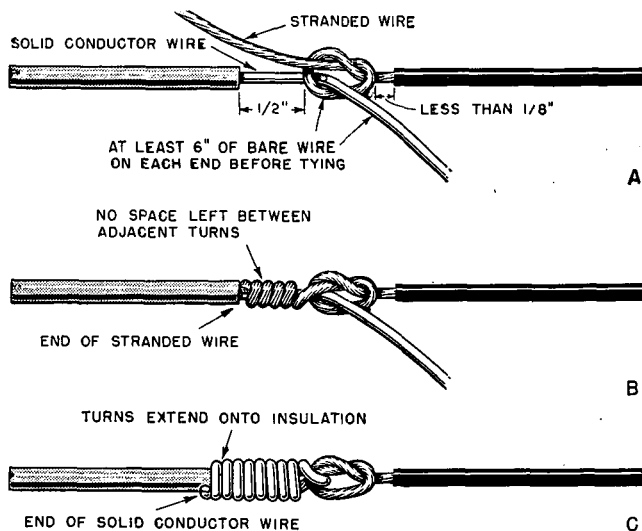

FIG - 17

Figure 11. Combination splice, solid to stranded conductor.

e. Bend the end of the solid wire back at the knot and wrap it around the stranded wire until 2 turns are taken on the insulation (C, fig. 11).

f. Wrap the solid wire in the direction opposite to that of the wrapping of the stranded wire. Cut off the excess solid wire and press the cut end down into the insulation.

g. Tape the splice as described in paragraph 8*f.*

10. T-Splice

The T-splice is used to splice one field-wire line to another without interrupting service. This is done when rerouting existing wire lines or when constructing a multiple party line. In figure 12, X_1 and X_2 are the conductors of the existing circuit and Y_1 and Y_2 are the conductors to be connected. Make the splice as follows:

a. Remove $1\frac{1}{2}$ inches of insulation from conductors X_1 and X_2 . The two bared spots should be 12 inches or more apart.

b. Place conductors Y_1 and Y_2 beside X_1 and X_2 . Cut Y_1 off at the bared spot in X_1 and prepare the ends of Y_1 and Y_2 for splicing.

c. Tie Y_1 and X_1 with a square knot as follows: with the left hand make a loop in the bared part of X_1 . With the right hand, pass the end of Y_1 up through the loop; over the right side, under and around the neck of the loop; over the left side and down through the loop. Tighten the knot. Be sure that the two conductors on which the strain is to be placed are on the same side of the loop; otherwise, the knot will not hold.

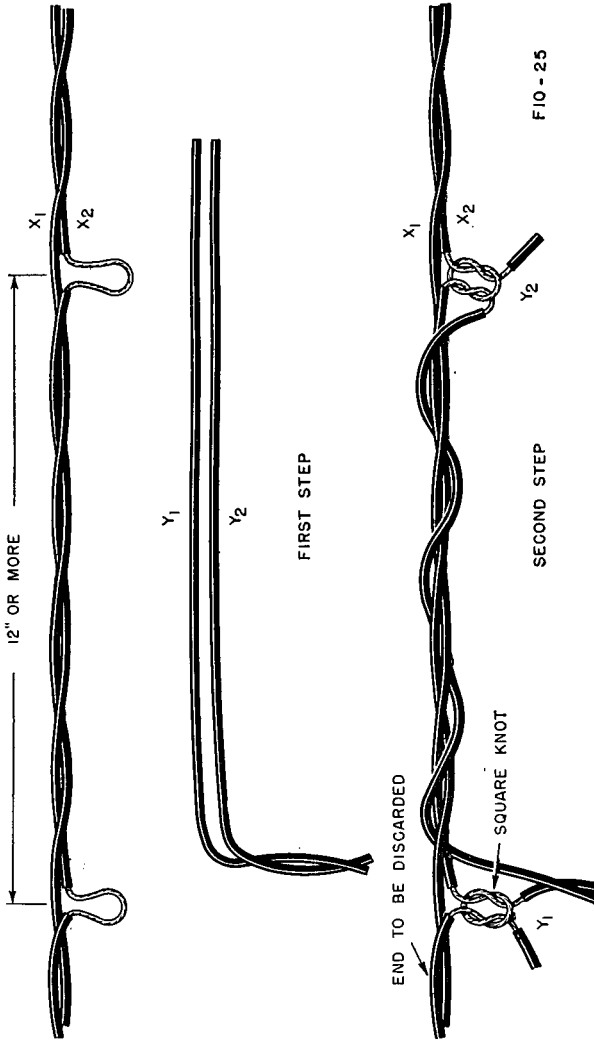

Figure 12. T-splice.

d. Twist Y_2 around X_1 and X_2 . Tie Y_2 to X_2 in the same manner described above. Assuming that once the splice is completed, the circuit going to the left of the splice will be disconnected, cut off the portion of the end to be discarded and complete the splice (par. 8*e* and *f*).

e. When the end is not to be discarded, complete the splice with seizing wire.

11. Splicing Stranded Insulated Wire to Bare Solid-Conductor Wire

Either a bridging connector or a combination seizing-wire splice (*b* below) is used to splice a stranded field-wire conductor to a solid open-wire conductor.

a. Bridging Connectors. These are threaded-bolt devices used to connect two conductors. Before using the bridging connector, clean the solid open-wire conductor at the point of connection. Place the bridging connector in position (top wire in fig. 13), and tighten the upper nut securely. Remove the insulation from the field wire, clean the strands, and wrap the bared end clockwise around the threaded part of the connector between the two washers. Tighten the lower nut securely.

b. Combination Seizing-wire Splice. To make this splice, remove about 1 inch of insulation from the end of the field wire. Clean both the stranded and solid conductors. Lay the bared end of the stranded wire along the solid wire. With a 12-inch piece of seizing wire, wrap 4 turns around the solid wire in back of the stranded wire. Continue wrapping the seizing wire. Take several turns over the

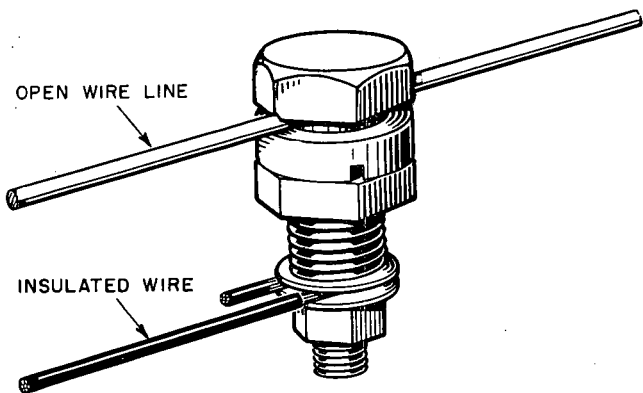

Figure 13. Field wire connected to open wire by bridging connector.

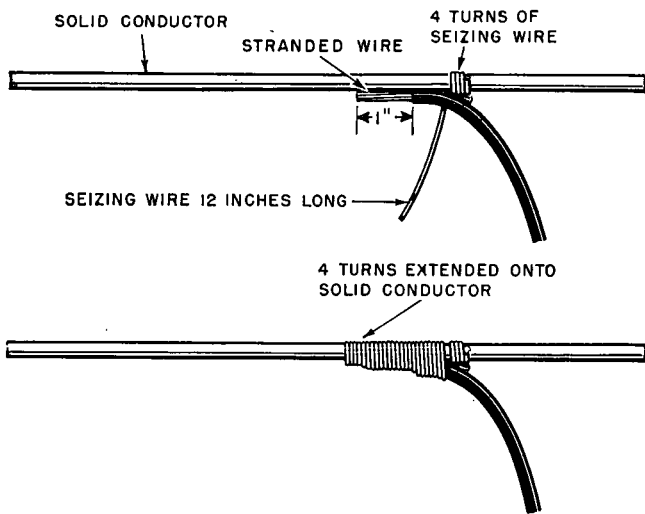

Figure 14. Combination seizing-wire splice.

insulation of the stranded wire, continue over the bare end of the stranded wire, and finally finish with 4 turns over the solid wire. Wrap the seizing wire tightly and draw the turns against each other.

c. Taping Combination Seizing-wire Splice. A combination seizing-wire splice is wrapped with two layers of rubber or electrical insulation tape covered by two layers of friction tape. This taping helps to hold the wires firmly in place and reduces corrosion due to the weather. The taping on the solid conductor should be extended well beyond the actual contact area of the two conductors (fig. 15).

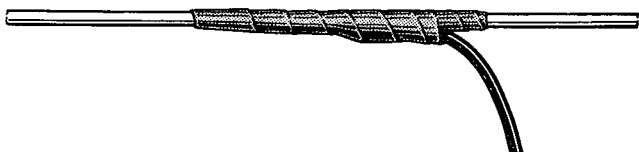

FIG - 26'

Figure 15. Taping a combination seizing-wire splice.

Section III. FIELD-WIRE TIES

12. General

a. Field-wire ties are used to hold wires in place and to relieve the strain on a wire line at the terminating points or equipment. All field-wire ties are made without cutting the wire; this allows rapid installation and recovery of the field-wire line.

b. Several kinds of ties are used in field-wire construction. For simplicity, certain illustrations in this section show only one of the two conductors of the field wire. Several wire terms are used when describing these field-wire ties. The *standing part*

bears the strain and is the part of the line that has been installed. The *running end* is the part of the line that leads to the wire-laying equipment. A *wire bight* is a loop formed by the wire (A, fig. 18).

13. Drip Loop

A drip loop (fig. 16) is always placed in a lead-in wire where the standing part of the wire is tied above the terminal equipment, such as at a telephone or terminal box. The drip loop causes the water running down the lead-in wire to drip off the bottom of the loop, and thus prevents the water from entering and damaging the equipment.

14. Clove Hitch Tie

A clove hitch tie is used to fasten a field-wire line to any object having an unobstructed top, such as a stake or a fence post. To make this tie, form two loops in the wire (A, fig. 17). Place the right hand loop on top of the left hand loop without turning either loop (B, fig. 17). Place both loops over the object to which the tie is to be made and tighten the loops (C, fig. 17).

15. Loop-Knot Ties

a. Overhead Loop-Knot Tie (fig. 18). This tie is used for short, temporary overhead spans. The loop-knot tie must not be used for long or permanent overhead spans because the tension causes the knot to bind and damages the insulation. This tie should not be used in places where it could become untied accidentally by passing personnel, vehicles, or animals. The tie is made as follows: place the wire between you and the object to which the tie is being made.

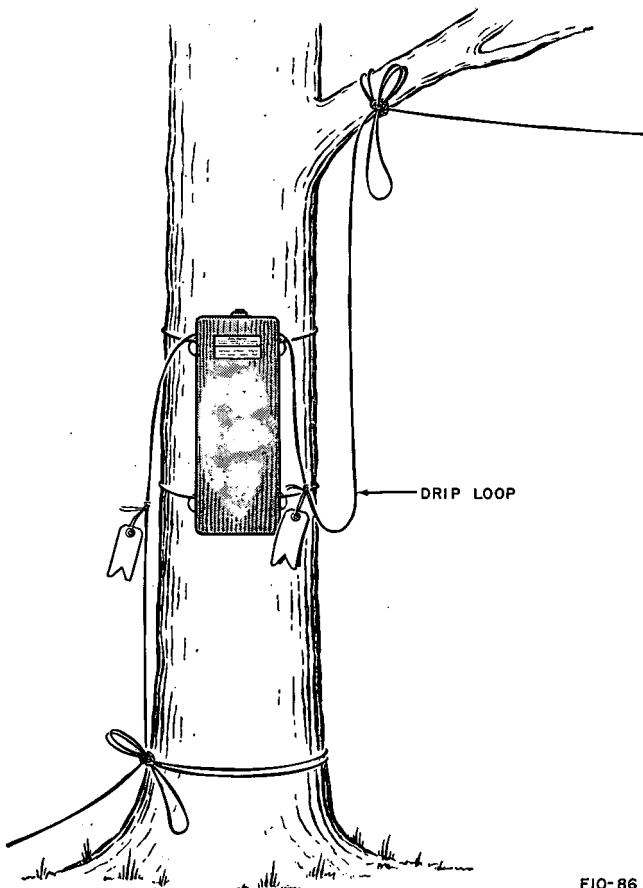

F10-86

Figure 16. Drip loop.

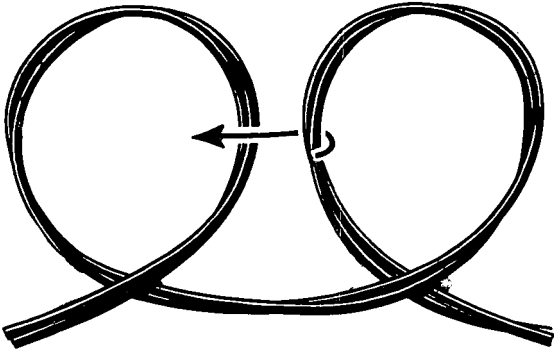

A

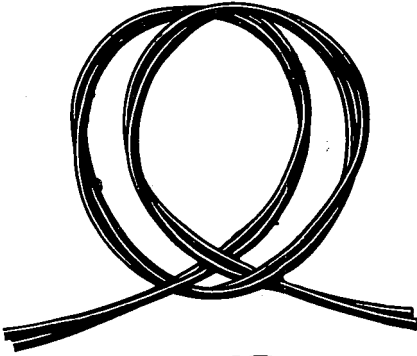

B

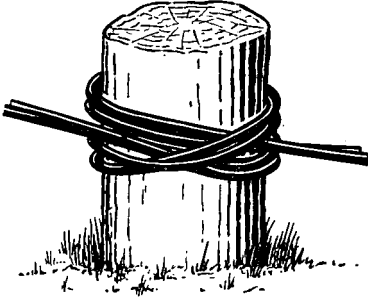

C

F10 - 19

Figure 17. Clove hitch tie.

Pull in enough slack to form a bight about the object plus an additional 3 feet. Pass the bight around the object (A, fig. 18). Place the bight around the object in the direction of the running end. (If a greater strain is on the running end, place the bight around the object in the opposite direction.) Bring the bight under and over both the standing and running ends to form a closed loop (B, fig. 18). Pass the hand through the loop and grasp the bight wire to form a double bight (C, fig. 18). Tighten the knot securely against the object (D, fig. 18). To unfasten the tie, pull the free lower loop.

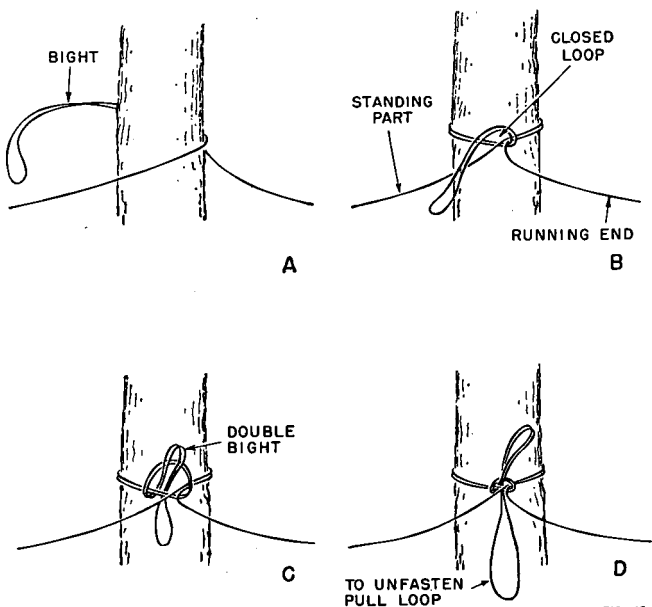

FIG-12

Figure 18. Overhead loop-knot tie.

b. Ground Loop-Knot Tie. This tie is made similar to the overhead loop-knot tie, except that the bight is brought over and under the standing part and running end to form the closed loop. The ground loop-knot tie is used when tying surface lines to objects near the ground line. This type of field-wire tie can be rapidly released when required.

16. Square Knot and Loop Tie

a. The square knot and loop tie (fig. 19) is more secure than the simple loop-knot tie, and it is used for the same purposes. To make the tie, pull in slack and pass a bight around the object plus an additional 3 feet (A, fig. 19). Bring the bight over the standing

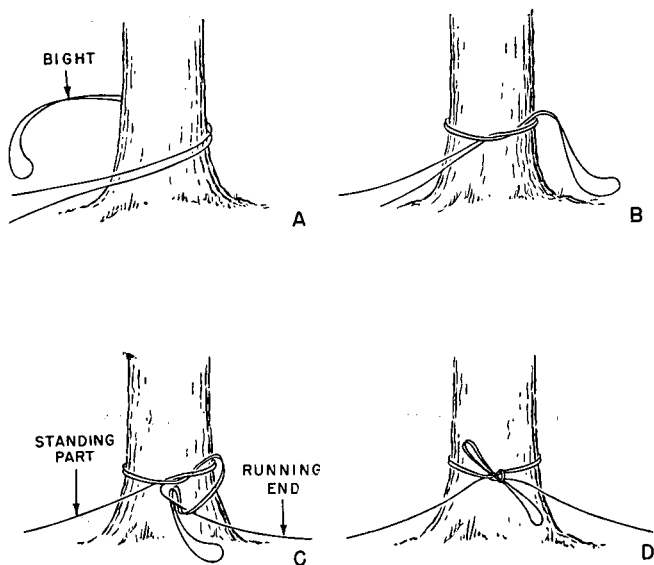

FIG-13.

Figure 19. Square knot and loop tie.

part and running end, and then between the object and the wire (B, fig. 19). Draw the knot tightly against the object. Bring the bight over the running end to form a closed loop opening (C, fig. 19). Reach through this opening and pull about 6 inches of wire through the opening to form a doubled bight (D, fig. 19). Tighten the tie by holding the doubled bight in one hand and pulling the running end with the other. To unfasten, pull the lower loop and untie the knot from the object.

b. The above tie can be made more secure by completing the square knot and eliminating the loop. To make a square knot tie, proceed as with the square knot and loop tie, but pull the end of the bight through the opening. Tighten the tie by holding the end of the bight in one hand and pulling the running end with the other.

17. Knob Tie

The knob tie (fig. 20) is used in tying field wire to small supports such as insulators and similar objects. This tie is not suitable for long spans. Make the knob tie as follows: form a loop in the wire (A, fig. 20), separate the two conductors in the loop (B, fig. 20), and bend back the loop in each conductor until the loops touch each other (C, fig. 20). Place the loop over the insulator, and pull on both the standing part and running end to secure the tie (D, fig. 20).

18. Marline Tie

The marline tie is used to suspend a field-wire line on a cross arm, or other support, when there is a

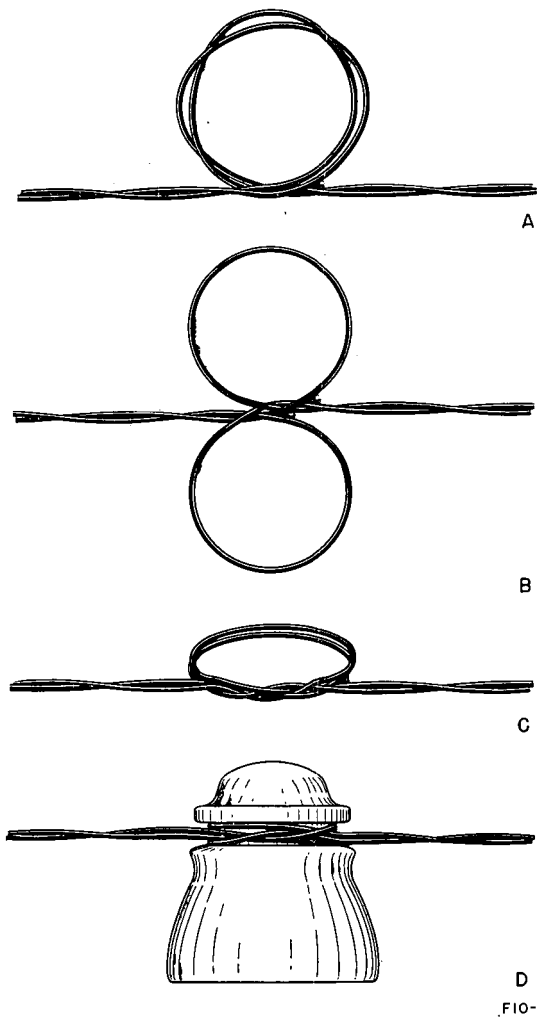

Figure 20. Knob tie.

possibility that the support might damage the wire insulation. Make this tie as follows:

a. Double a piece of marline that is long enough for the tie.

b. Pass the marline under the wire and pass the ends of the marline through the loop of the doubled marline. Draw the marline tightly around the wire.

c. Pass the doubled marline twice around the support and back to the wire (A, fig 21). Fasten the ends of the marline to the wire with a clove hitch knot (B, fig. 21).

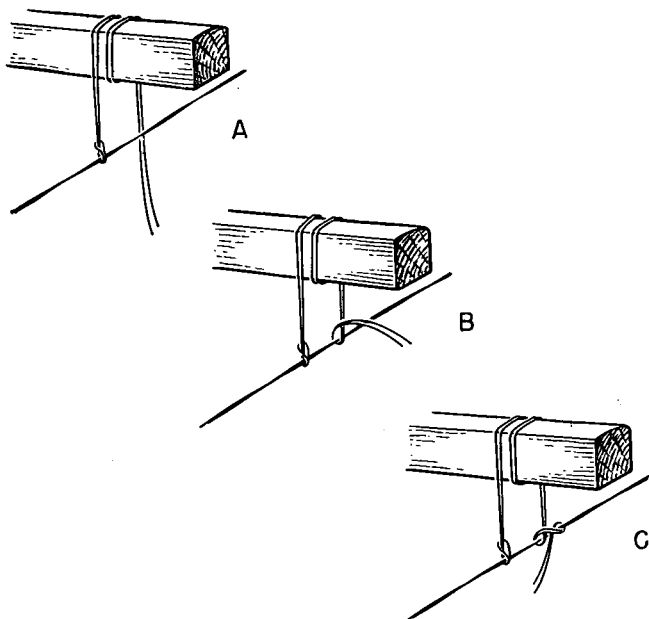

FIG-23

Figure 21. Marline tie to cross arm.

d. To tie a clove hitch knot, place the marline around the wire and pass the running end over the standing part to form a loop. Pass the running end down through this loop (C, fig. 21) and tighten the knot.

19. Basket Hitch Tie

a. The basket hitch tie is used as an aerial tie for field wire under conditions of extreme heat, long spans, heavy wind, or icing. It is used under all conditions for aerial support of multiple pairs of field wire (cable) and field cables.

b. The basket hitch tie used at the termination of overhead span is made as follows: with a 10- to 12-foot length of field wire, make a clove hitch around the wires that are to be supported (A, fig. 22). (The clove hitch (B, fig. 17) in this case is formed by wrapping the tie wire *around* the wire or cable to be supported. If the clove hitch slips, wrap several turns of friction tape at this point.) Weave the tie wire around the wires, placing the tie wire alternately on the inside of one cross and on the outside of the next cross. When the wires are tied in this manner, the gripping action will be evenly distributed for the entire length of the tie. Usually seven crossovers will be sufficient to hold the supported wire. To complete the tie, hold the two ends of the tie wire together and make $1\frac{1}{2}$ turns around the support. Separate the two ends. Bring one end over and one end under the standing part of the tie wire (B, fig. 22). Tie the two ends together with a square knot and cut off the excess wire (C, fig. 22).

c. Two basket hitch ties are used at each non-

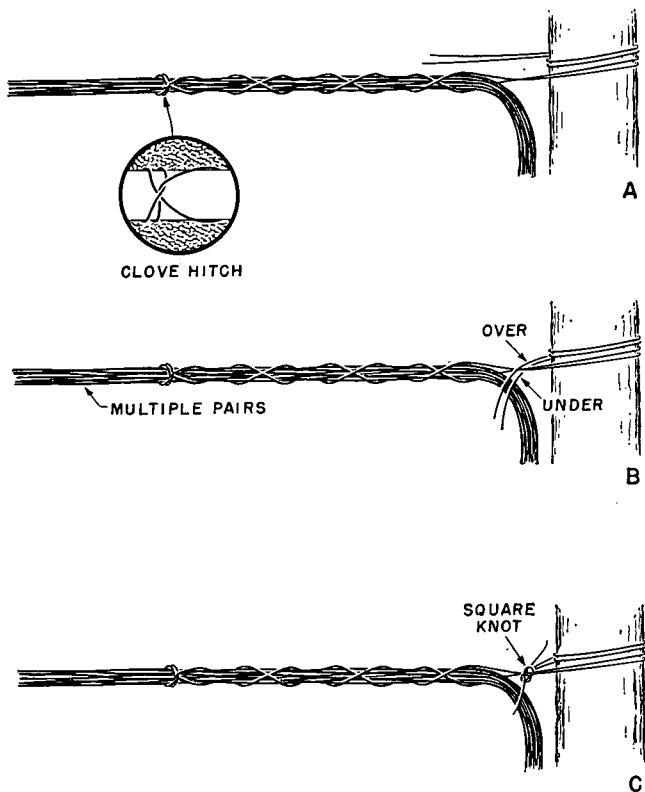

F10-24

Figure 22. Basket hitch tie at termination of an overhead span.

terminating support point of an overhead construction. Loop the line around the support in such a manner that the line will not rub against the support (fig. 23). Make the ties as explained in *b* above.

d. It is simpler for the wireman to make the basket

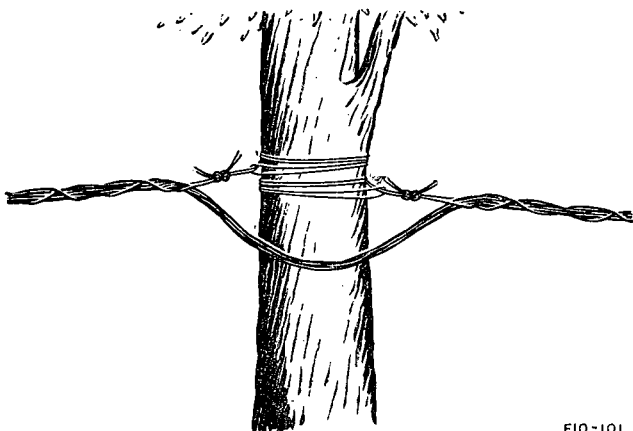

FIG-101

Figure 23. Basket hitch tie supporting an overhead span.

hitch tie on the ground before climbing the support for the line. After the line has been secured on one support, stand at the base of the next support and pull the line tight to the center of the next support at ground level. Measure back toward the first support a distance of 2 feet. Start the basket weave tie at this point. This method will allow the necessary amount of sag in the line when the span is completed. (Sag is the vertical distance between the lowest point on the line and the two points of suspension.) If a tie is required in the midsection of the line suspension, the second basket hitch tie also should be made at this time.

20. Variation of Basket Hitch Tie

a. A method of suspension employing a variation of the basket hitch tie is well-suited for jungle areas. This tie places no knots in the wire line and allows

for considerable swaying of the tree or other support without placing an increased strain on the wire. It allows suspension from a horizontal or vertical support and is made the same, whether in the mid-section or at the first or last support. The disadvantages of the tie are: it is slow to make; it must be made at the point of suspension; it cannot be started on the ground as in the case of the usual basket hitch tie.

6. Make the tie (fig. 24) as follows: loop a piece of field wire twice around the tree or other similar support and tie a square knot. Leave the free ends of the tie wire about 2 or 3 feet long. Twist these tie-wire ends together to form a double twisted pair for a distance of 6 inches below the square knot. Make an overhand tie (first step in making a square knot). Insert the line to be suspended between the two tie-wire ends and tie a square knot. Untwist the opposite ends of the tie wire. Weave the untwisted

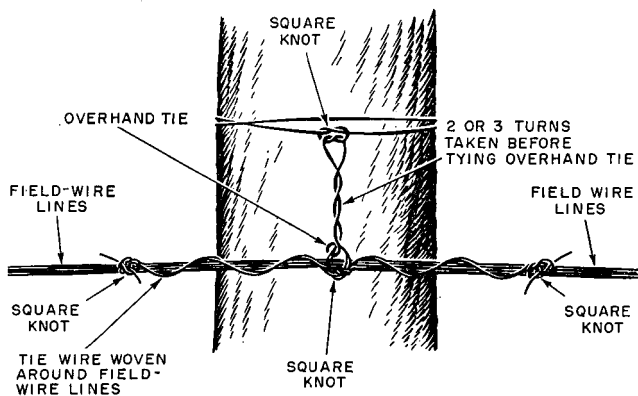

FIG-76

Figure 24. Variation of basket hitch tie.

tie-wire ends in opposite directions along the wire to be suspended. Weave both portions of each tie-wire end around the wires to be supported. Make sure that one portion of the tie wire lays on the inside of one cross and on the outside of the next cross. After four or five crossovers, tie both portions of each tie-wire end in a square knot and cut off the excess wire. Use friction tape, where needed, to prevent the tie wire from slipping.

21. Weave Tie

a. Use. The weave tie (fig. 25) is another variation of the basket hitch tie and is used to support multiple-pair cable and aerial field-wire lines for semipermanent installations. It also can be used to attach field wires to ground supports such as stakes or bases of trees, and for corner supports.

b. Making Tie. A 4- to 8-foot piece of field wire is used to make the weave tie. In overhead construction, place the wires high enough to maintain standard road clearances. Fasten the tie wire to the support with a clove hitch. If the support is large, make only one loop and tie with a square knot. Separate the twisted conductors of each end of the tie wires (about 18 inches are needed to complete the tie). Pull the wire line up against the clove hitch or square knot. Weave the tie wire along the wire line at least 8 inches in both directions. Terminate the tie wire ends in square knots. Increase the length of the weave for long spans. Trim the excess wire from the square knot. Use friction tape, when necessary, to prevent the tie wire from slipping.

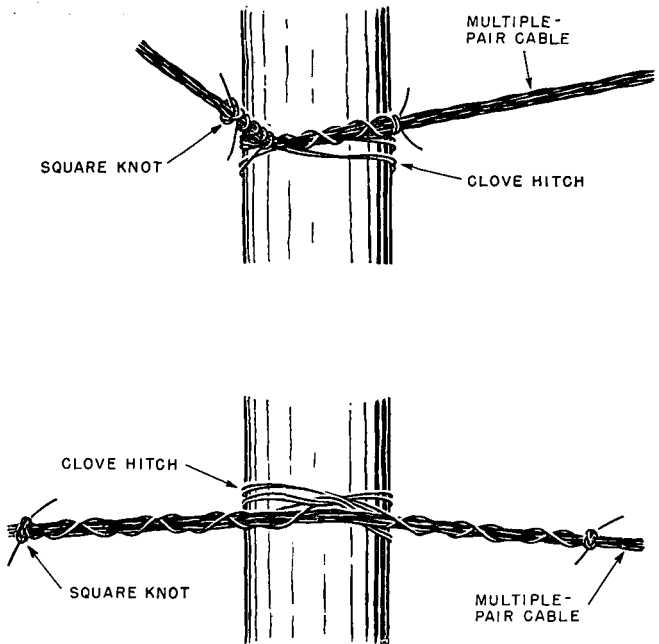

F10-82

Figure 25. Weave tie used with field wire.

22. Connecting Field-Wire Line to Open-Wire Line

When a field-wire line must be connected to an open-wire line, splice the field-wire conductors to the open-wire conductors as described in paragraph 11. Fasten the field wire to the cross arm or pole (never to the metal brace) near the splicing point (fig. 26). Leave a little slack between the tie and the splice. The tie should take the strain since the splice will

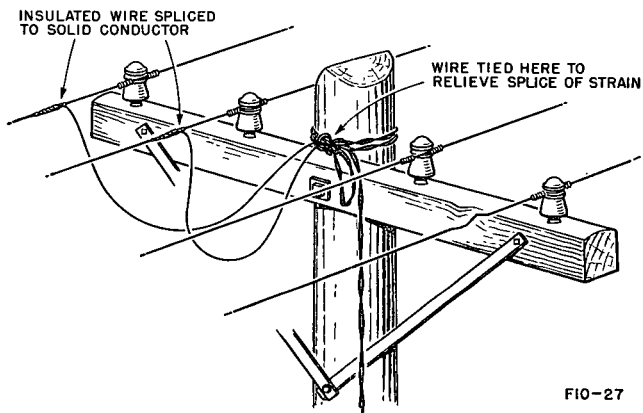

Figure 26. Tying in field wire to open wire.

not withstand a heavy pull. Position the tie on the cross arm or pole in such a manner that each field-wire conductor will not touch any open-wire conductor except the one to which it is spliced.

CHAPTER 3

FIELD CABLES

23. General

a. Although he works mainly with field wire, the field wireman might be required to install sections of field cable or use existing field cables within an area of operations.

b. There are two standard types of field cables: five-pair cable (Cable Assembly CX-162/G) and spiral-four cable (Cable Assembly CX-1065/G).

c. Construction methods for field cables and field wire are similar. Field cables can be placed on the ground, buried, and suspended from trees, poles, or from rapidly erected supports. For detailed information on construction and maintenance of field cables, refer to TM 11-369, TM 11-371, and TM 11-381.

24. Five-Pair Cable

a. Cable Assembly CX-162/G consists of five pairs of rubber-insulated, color-coded, #19 AWG tinned solid-copper conductors. Cotton cord is used in the center and as a filler between pairs. A cotton yarn separator is applied over the assembled conductors, and black, vulcanized rubber or synthetic rubber is molded around the outside to form the cable jacket. The cable is equipped with a connector on each end.

b. Five-pair cable is furnished in 1,000-, 500-, 200-, 100- and 12-foot lengths. The 12-foot length of five-

pair cable (Cable Stub CX-163/G) is usually called a stub. The stub has a connector at one end which connects to Cable Assembly CX-162/G and the individual cable conductors at the other end are separated to permit connection to binding posts.

c. Five-pair cable is used where a number of pairs are required along the same route for short distances. It is particularly useful for installing circuits from a wirehead to the switchboard in a command post, or as a distribution cable for local circuits.

25. Spiral-Four Cable

a. *General.* Spiral-four cable is normally used to form a four-wire transmission line of a carrier communication system. It also can be used for long-distance voice-frequency circuits. The common name *spiral-four cable* is used when reference is made to any or all of the following assemblies.

b. *Telephone Cable WF-8/G.* Telephone Cable WF-8/G (fig. 27) consists of four stranded-copper conductors separately insulated with polyethylene and spiraled around a polyethylene core. Only one pair of the spiral-four cable is colored. The spiraled conductors are covered by an inner jacket of polyethylene, a carbon-cloth stabilizing tape, a steel braid, and a thermoplastic outer jacket. The steel braid gives tensile strength to the cable and allows the cable to be used in self-supported aerial cable lines. Telephone Cable WF-8/G is part of Cable Assembly CX-1065/G and also Telephone Cable Assemblies CX-1606/G and CX-1512/U.

c. *Universal Connectors.* The universal connector (fig. 28) provides a high-quality, waterproof, elec-

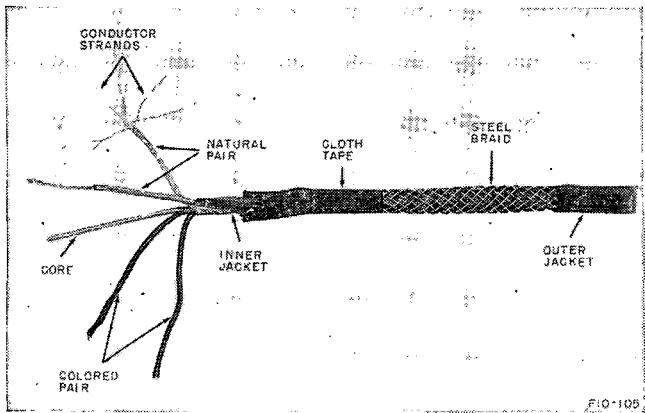

Figure 27. Telephone Cable WF-8/G, construction details.

trical circuit connection between two cable assemblies. The connectors are joined together by hand as shown in figure 29.

d. Cable Assembly CX-1065/G. This cable assembly consists of approximately one-fourth mile (1,280 to 1,360 feet) of spiral-four cable (Telephone Cable WF-8/G) fitted at each end with a universal connector. These assemblies, although varying in length, are identical in electrical characteristics. The assemblies are joined together to form a transmission line of any required length. A pair of conductors connect the male contacts of the connector at one end to the female contacts of the connector on the other end of the assembly. The steel braid is connected to the connector case at each end. The cable assembly is supplied with Reel DR-15-B (fig. 30). The storage compartment on the reel holds both connectors plus about 12 feet of the inner end of the cable.

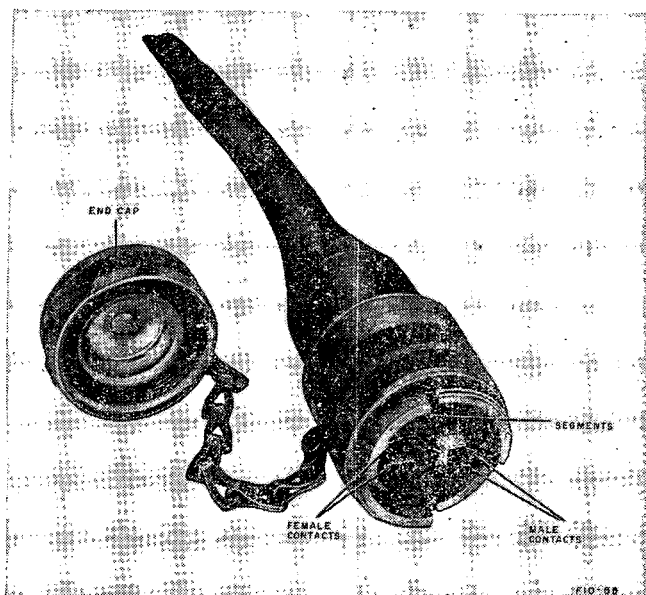

Figure 28. Universal connector.

e. Telephone Cable Assembly CX-1606/G. This assembly consists of 100 feet of spiral-four cable (Telephone Cable WF-8/G) fitted at each end with a universal connector. It is used with the one-fourth mile lengths of spiral-four cable to obtain a transmission line of the required length.

f. Telephone Cable Assembly CX-1512/U. This assembly is a cable stub and consists of 12 feet of spiral-four cable (Telephone Cables WF-8/G) fitted at one end with a universal connector. The four conductors and steel braid are separated at the other end, allowing the spiral-four cable to be connected to terminal equipment not equipped with uni-

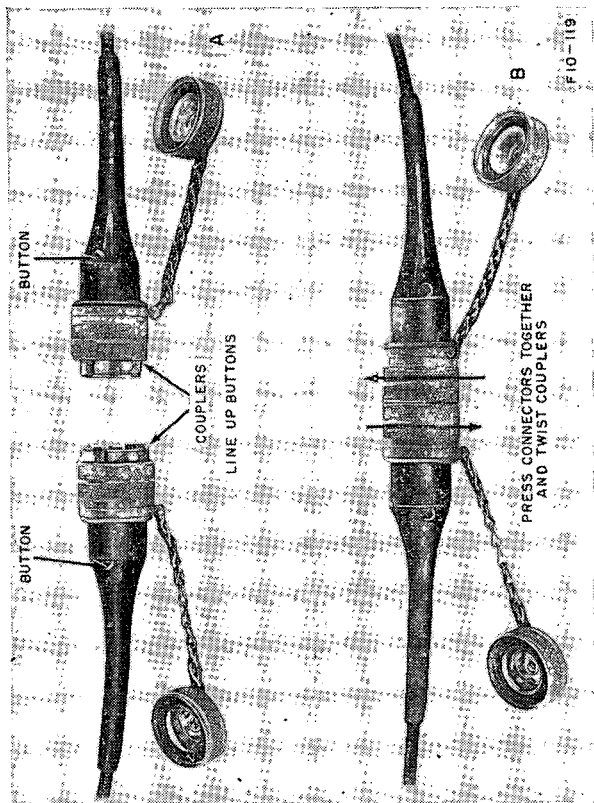

Figure 29. Joining connectors.

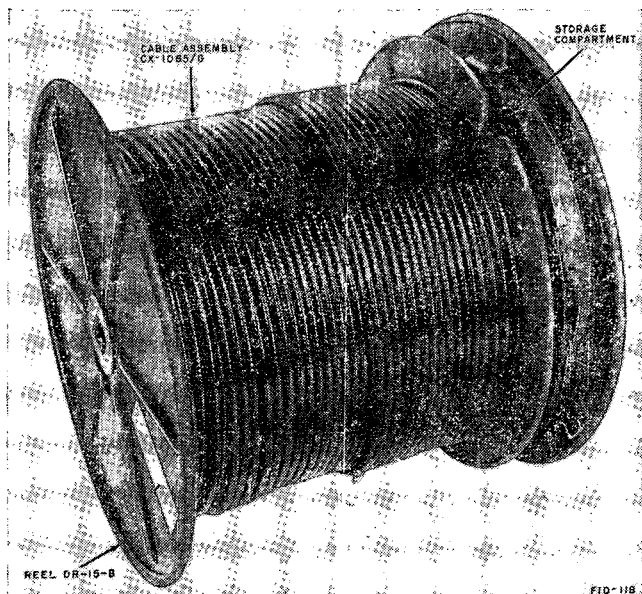

Figure 30. Cable Assembly CX-1065/G, wound on Reel DR-15-B

versal connectors. A nylon yarn braid covers the open ends of the steel braid. The steel braid termination is made at the top of the nylon braid for ease of identification. The conductors are bared about three-fourths of an inch and tinned. The tinned ends prevent fraying of the conductor strands and give a better electrical connection.

g. Telephone Loading Coil Assembly CU-260/G. This is a metal cylinder about 5 inches long and 2 inches in diameter which connects the two universal connectors of adjoining cable assemblies (fig. 31). The loading coil contains a pair of 6-millihenry load-

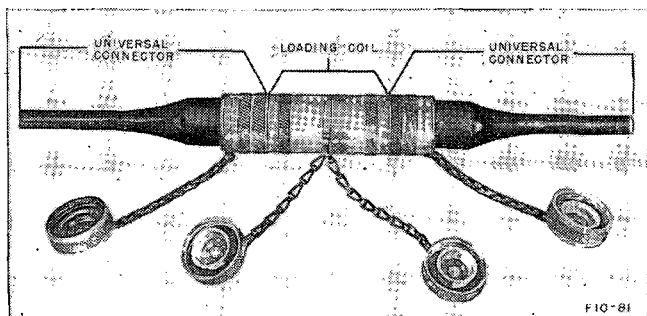

Figure 31. Telephone Loading Coil Assembly CU-260/G, joining two universal connectors.

ing coils which increase the transmission quality of the cable.

26. Spiral-Four Cable Expedient Field Splice

(figs. 32, 33, and 34)

After a cable fault has been located, communication over the cable must be restored immediately. In many cases, the fastest method of restoring service over a faulty cable is to replace the defective section. If replacement of the defective section is not possible and the fault is visible, cut the cable at the defective part and make a temporary field splice as described below:

- a. Prepare the cable ends for splicing as follows:
 - (1) Cut through the outer jacket, completely around the cable (A, fig. 32) about $4\frac{1}{2}$ inches from the end.
 - (2) Make two lengthwise slits along the jacket on opposite sides of the cable. Extend the slits from the circular cut to the point to be spliced.

- (3) Use pliers to remove the cut pieces of the outer jacket from the cable.
- (4) Loosen the exposed wire braid. Use a screwdriver or similar tool to separate the strands of the steel braid (B, fig. 32).
- (5) Cut the exposed steel strands to a length of about 2 inches.
- (6) Apply a few turns of friction tape around the outer jacket just back of the cut end and fold back the steel strands. Tape the steel strands tightly against the cable (C, fig. 32).
- (7) Remove the cloth tape (C, fig. 32) from the inner jacket.
- (8) Cut a nick one-half inch from the end of the outer jacket completely around the inner jacket (D, fig. 32). Be careful to cut only part way through the inner jacket. Flex the inner jacket and conductors until the inner jacket separates at the nick.
- (9) Make a one-fourth inch lengthwise cut through the inner jacket at the end of the cable (D, fig. 32). Make the cut between the two pairs of conductors.
- (10) Grasp either cut end of the inner jacket with pliers, and pull outward. The inner jacket will peel away from the insulated conductors.
- (11) Cut the core of the cable close to the end of the inner jacket.
- (12) Remove the insulation from each conductor to within one-half inch of the inner jacket (A, fig. 33). Scrape the conductors clean.

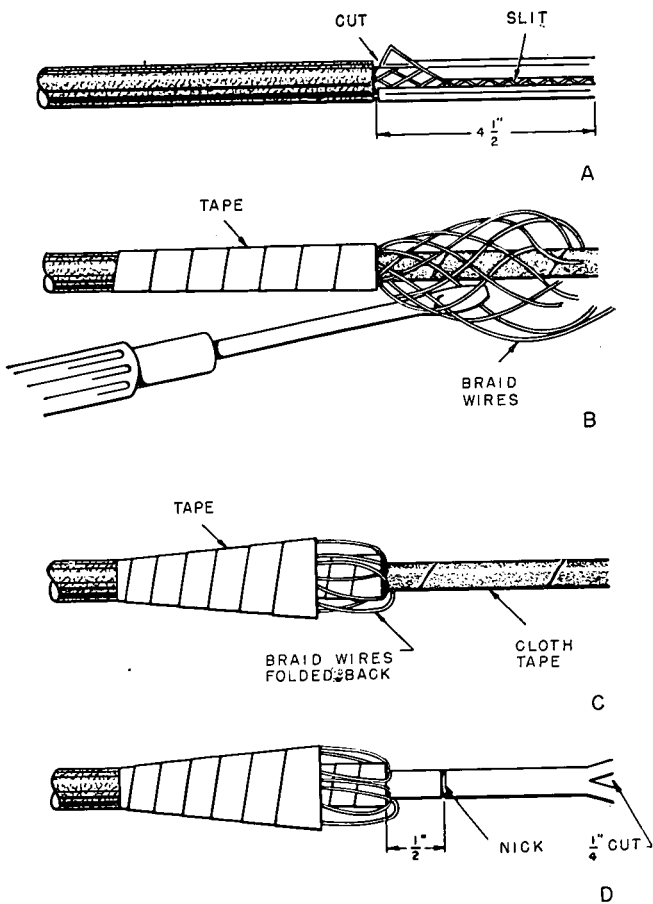

F 10-112

Figure 32. Preparing ends of cable for field splice.

- b. Splice the individual conductors as follows:
- (1) Select two identical color-coded conductors. Connect these conductors together with two loose twists, totaling 1 inch in length (B and C, fig. 33).

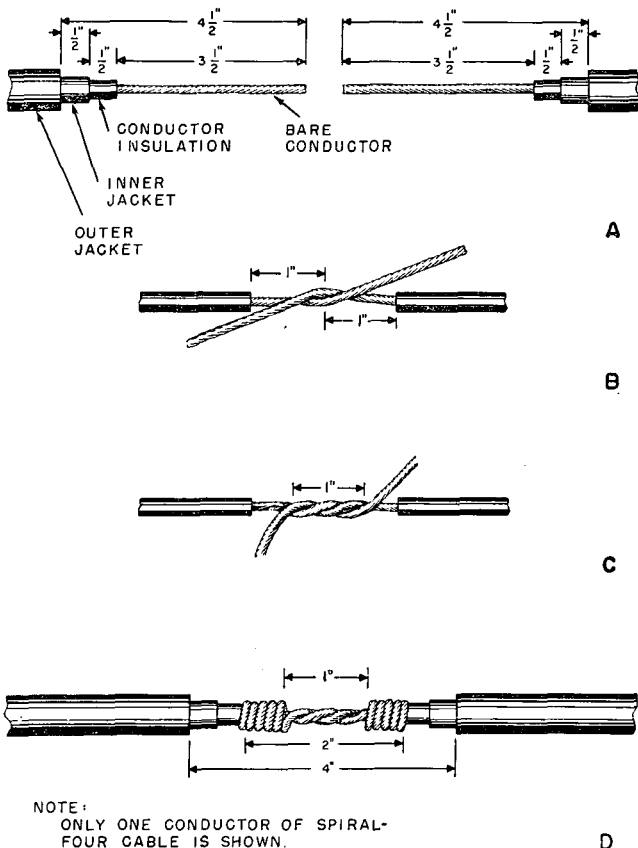

F10-114

Figure 33. Splicing the conductors of spiral-four cable.

- (2) Twist each loose end tightly around the other conductor (at least 5 turns) until the conductor insulation is reached (D, fig. 33).
 - (3) Wrap the splice (A, fig. 34) with two layers of polyethylene tape (Electrical Insulation Tape TL-600/U and TL-636/U). While wrapping the splice, stretch the tape to at least twice its original length.
 - (4) Start taping at the center of the splice. Extend the wrap one-fourth inch on the conductor insulation and lap each turn one-half the width of the tape.
 - (5) Reverse the direction of wrapping and extend the wrap one-fourth inch on the other conductor insulation.
 - (6) Cover the polyethylene tape with a layer of friction tape (Friction Tape TL-83) wrapped from one end of the splice to the other (B, fig. 34).
 - (7) Wrap the four spliced conductors with two layers of polyethylene tape (C, fig. 34). Cover the polyethylene tape with a layer of friction tape (D, fig. 34).
- c. Complete the cable splice as follows:
- (1) Electrically, the steel braid of both cables must remain unbroken. To restore electrical continuity, tightly wrap 6 turns of copper wire over the exposed steel strands on one side of the splice. Spiral the copper wire across the splice and wrap 6 turns on other end of the splice (C, fig. 34). A piece of copper conductor removed from the damaged cable is suitable for this braid-connect-

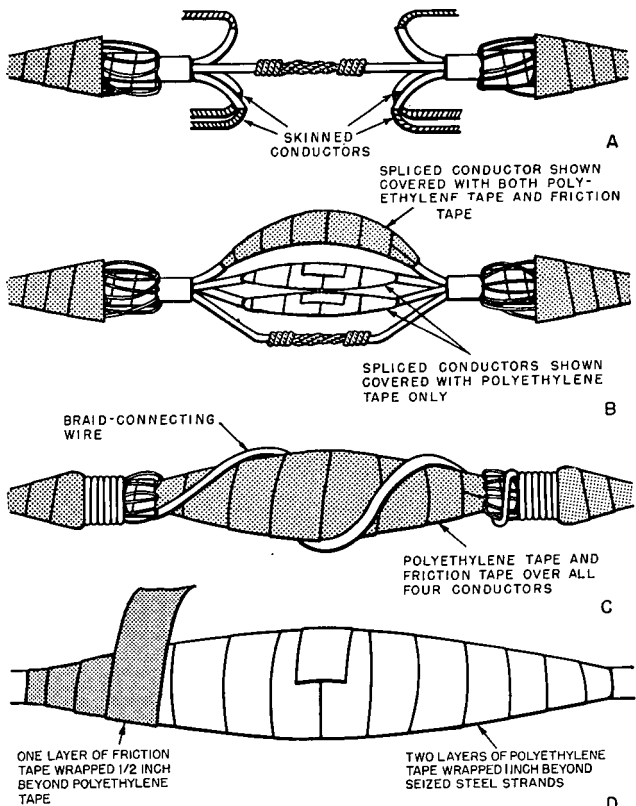

FIG-106

Figure 34. Expedient field splice.

- ing wire (any copper wire, #22 AWG or larger, will serve this purpose).
- (2) Clean and dry the surface of the cable about the splice.
 - (3) Wrap the entire splice with two layers of polyethylene tape. Start taping at the

center of the splice. Stretch the tape and half-lap each turn.

- (4) Wrap 1 inch beyond the seized steel strands at the one end of the splice.
- (5) Reverse, and wrap 1 inch beyond the seized steel strands at the other end of the splice.
- (6) Reverse again, and end the wrapping at the center of the splice (D, fig. 34).
- (7) Wrap a half-lapped layer of friction tape around the splice, starting one-half inch beyond the polyethylene tape and continuing across the splice. End the friction tape one-half inch beyond the polyethylene tape at the other end of the splice.

d. Test the splice before restoring the cable to service.

e. The field splice has very little tensile strength. Therefore, a tension bridge must be made to take the strain off the finished splice. This is done by means of a basket hitch tie as shown in figure 35.

Note. When pressed splicing sleeves and sleeve-crimping tools are available, the splicing is performed as described in TM 11-381.

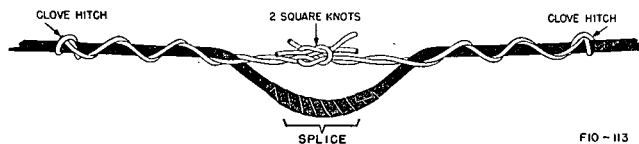

Figure 35. Tension bridge over field splice, using basket hitch tie.

CHAPTER 4

WIRE-LAYING AND WIRE-RECOVERY EQUIPMENTS

27. General

Wire DW-1/TT is stored, transported, layed, and recovered with the use of metal spool-type reels. Special canvas containers known as *dispensers* are also available for laying field wire. All reels require some type of mounting to simplify the laying and retrieving of wire. These are called *wire-laying* equipments and are made in various types and sizes for operation under various conditions.

28. Field-Wire Reels and Dispensers

The four types of reels (fig. 36) and the wire dispenser available for use with wire-laying equipment are listed as follows:

a. Reel DR-4 is a metal spool-type container used to transport, lay, or recover field wire. It contains approximately $1\frac{1}{3}$ miles of field wire and can be mounted on Axle RL-27-D, Reel Unit RL-31-(), or Reel Cart RL-35-A.

b. Reel DR-5 is a metal spool-type container used to store, transport, lay, or recover field wire. It contains $2\frac{1}{2}$ miles of field wire and can be mounted on Reel Unit RL-26-(), RL-31-(), or Reel Cart RL-35-A.

c. Wire Reel RL-159/U is a metal spool-type container used to store, transport, lay, or recover field wire. It contains 1 mile of field wire and can be mounted on Reel Unit RL-26-(), RL-31-(), Reel Cart RL-35-A, or Axle RL-27-D.

d. Spool DR-8-A is a metal container used to lay or recover field wire. It contains one-fourth mile of field wire and can be mounted on Reel RL-39-() (component of Reel Equipment CE-11).

e. Wire Dispenser MX-306A/G is a canvas wire dispenser designed for laying field wire without the use of reel units. The dispenser contains approximately one-half mile of field wire. Refer to paragraph 30 for more detailed information on this dispenser.

29. Packboard

Where required by the terrain or tactical situation, field wire can be laid with a reel or dispenser attached to a packboard strapped to the back of a wireman. Normally, another wireman follows the man carrying the packboard to aid in unreeling the wire, preventing snarls, making field ties, and similar functions.

30. Wire Dispenser MX-206A/G

a. Wire Dispenser MX-306A/G (fig. 37) is a cylindrical canvas and tape container holding approximately one-half mile of Wire WD-1/TT. Two or more dispensers are connected in tandem when it is desired to lay more than one coil of wire without stopping to make a splice. Figure 38 shows the method of splicing wires in dispensers for tandem operation. The dispenser has many useful features:

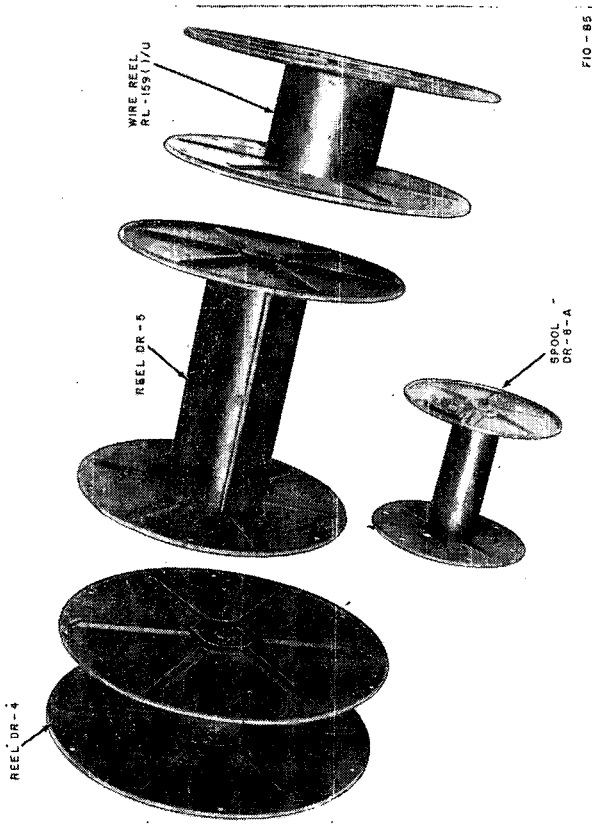

FIG - 85

Figure 36. Reels for field wire.

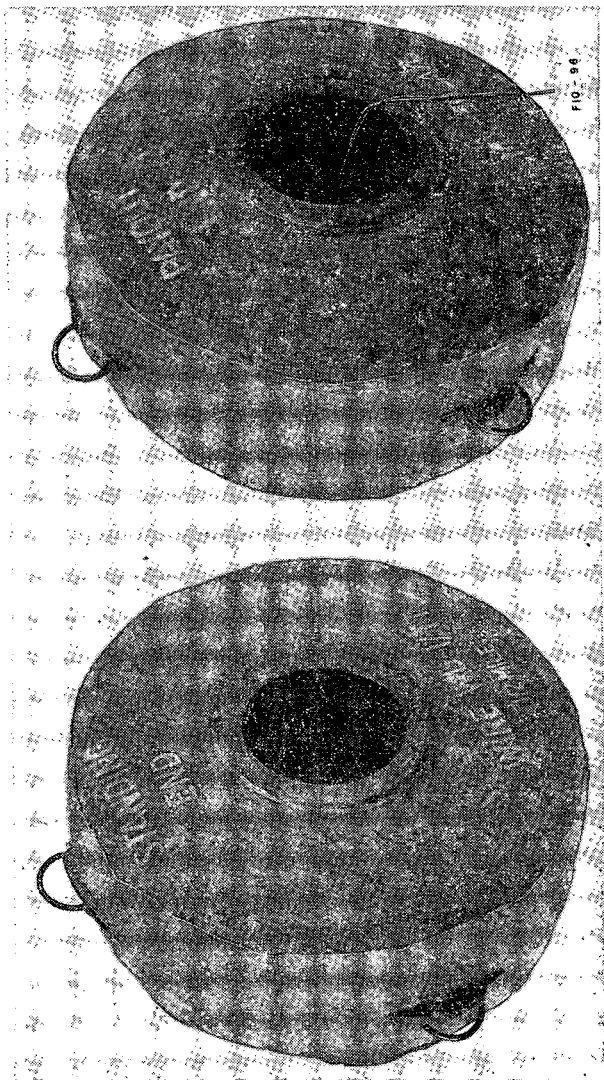

Figure 87. Wire Dispenser MX-306A/G.

- (1) Its portability makes the dispenser highly desirable to mountain, ski, and other ground troops that use packboards and hand or shoulder slings to lay wire.
- (2) The dispenser allows wire to be laid at high speeds from land and amphibious vehicles, or from fixed-wing and rotary-wing aircraft. It will accommodate speeds up to 100 miles per hour.

b. No special mounting devices are necessary if a single dispenser is used to lay wire, either by foot (fig. 39) or from a vehicle. However, if several dispensers are connected in tandem or placed in parallel to form a field cable (fig. 75) a means must be provided to support and aline the dispensers behind each other. The wire is laid from one end only (the end marked PAYOUT END). The wire within the dispensers should be tested for continuity and short circuits before placing it in use.

c. For more detailed information refer to TM 11-2240.

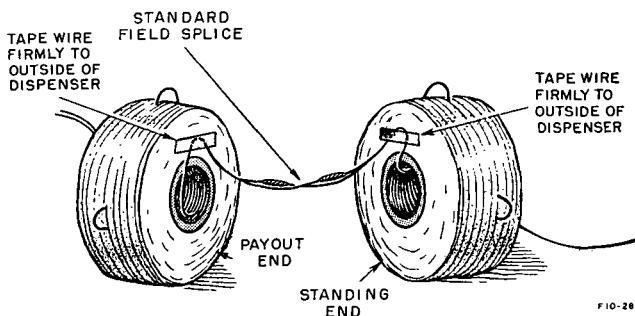

Figure 38. Wire Dispensers MX-306A/G, spliced for tandem operation.



FIG-98

Figure 39. Paying-out field wire, using Wire Dispenser MX-306A/G.

31. Axle RL-27-D

Axle RL-27-D (fig. 40) is a simple equipment used with wire reels to lay and recover field wire. The axle is a 2½ foot long machined-steel bar used

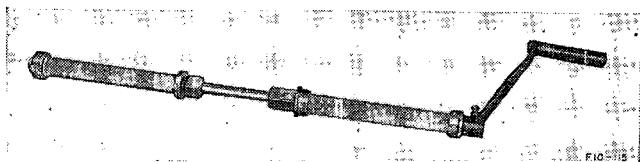

Figure 40. Axle RL-27-D.

for mounting wire reels. The axle has two knurled handles, one of which is removable for slipping on either Reel DR-4 or Wire Reel RL-159/U. The axle has roller bearings and is equipped with a removable crank for recovering and rewinding wire on the reel. The axle and reel can be carried by two men (fig. 41) or placed on some improvised mounting (fig. 42).

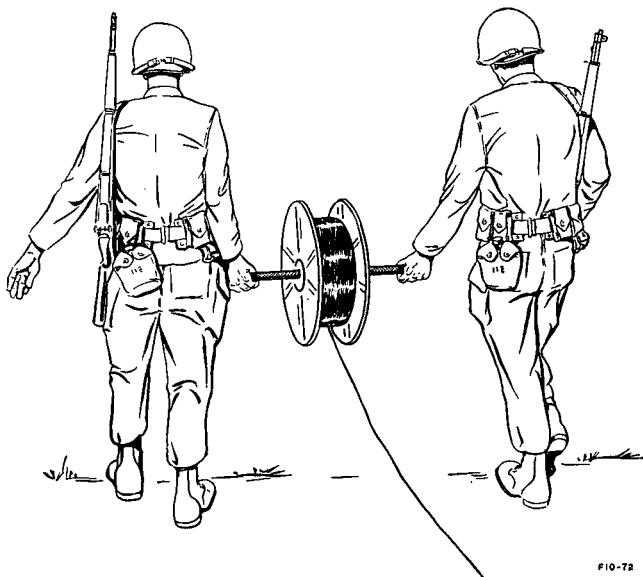

Figure 41. Method of laying field wire, using Axle RL-27-D.

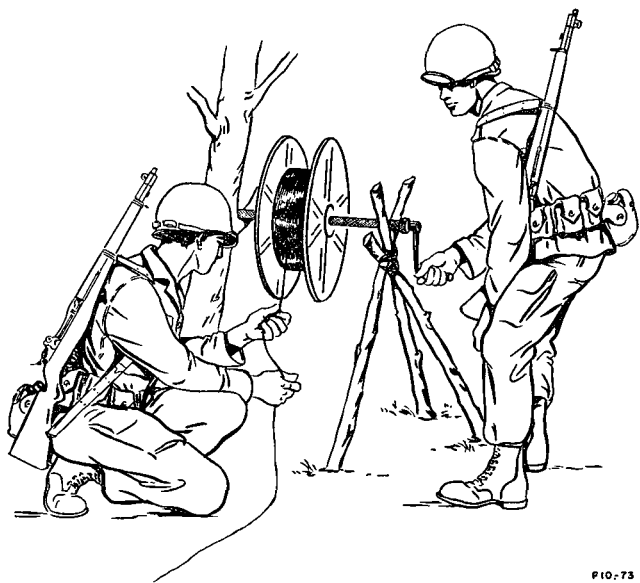

FIG. 73

Figure 42. Method of recovering field wire, using Axle Reel Unit RL-27-D.

32. Reel Unit RL-31-E

a. Reel Unit RL-31-E (fig. 43) is a lightweight, portable, folding A-frame of steel tubing used for paying out and recovering field wire and field cable. The reel unit has:

- (1) *Brake units* for controlling the speed of the wire reels during pay-out of the wire.
- (2) *Cranks* for reeling in wire on reels.
- (3) *Carrying straps* for carrying the reel unit litter style.
- (4) *Divided axle* for use when two reels are mounted on the reel unit. This axle allows

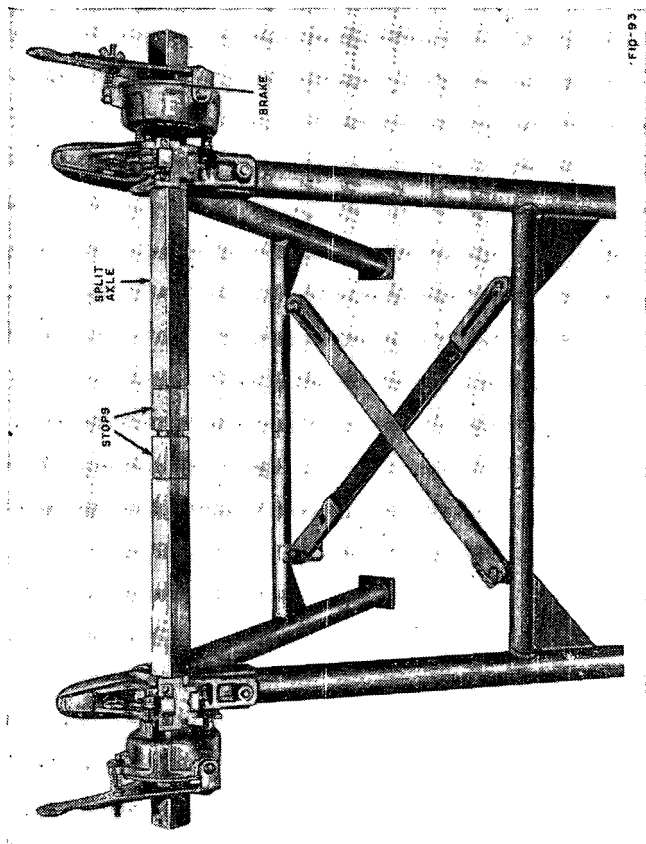

Figure 43. Recl Unit RL-31-E.

either reel to operate independently of the other.

b. The reel unit is capable of carrying a single Reel DR-5, DR-7, or DR-15; or two Reels DR-4 or Wire Reels RL-159/U. (Reels DR-7 and DR-15 are used with field cables.)

c. Reel unit RL-31-E can be set up on the ground or mounted on a vehicle (fig. 44). A special vehicular installation kit is available for mounting the reel unit in trucks.

d. For additional information, see TM 11-362.



F 10-87

Figure 44. Paying out field wire from Reel Unit RL-31-E mounted in truck.

33. Reel Equipment CE-11

a. Reel Equipment CE-11 (fig. 45) is a light-weight portable unit designed to be carried by one man. It consists of Reel Unit RL-39, and a sound-powered telephone handset. Reel Unit RL-39 mounts Spool DR-8-A having a capacity of one-fourth mile of Wire WD-1/TT (wire not included

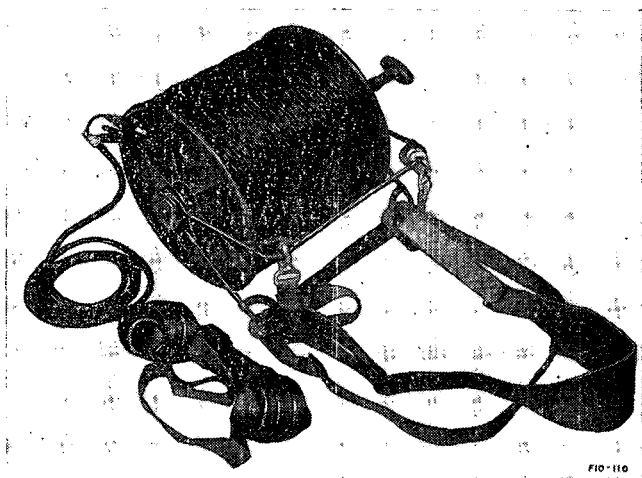

Figure 45. Reel Equipment CE-11.

as a component). Two adjustable, cotton-webbed straps support the reel unit during recovery of the wire (fig. 47).

b. The method of laying field wire is shown in figure 46. In forward areas when it is necessary to crawl toward the objective, the spool can be pulled along the ground to unwind the wire.



Figure 46. Laying wire with Reel Equipment CE-11

c. The operator of the reel unit may at any time establish communication with the rear by connecting the sound-powered telephone to the wire terminals on the spool.

d. For additional information, see TM 11-2250.



Figure 47. Recovering wire with Reel Equipment CE-11.

34. Reel Unit RL-26-()

a. Reel Unit RL-26-() (fig. 48) is a transportable wire-laying and wire-recovery machine driven by a gasoline engine. It is usually vehicular-mounted but it can be operated on the ground. The reel capacity of this unit is two Reels DR-5, two Reels DR-15-B, or four Wire Reels RL-159/U. The wire can be payed out from either reel singly or

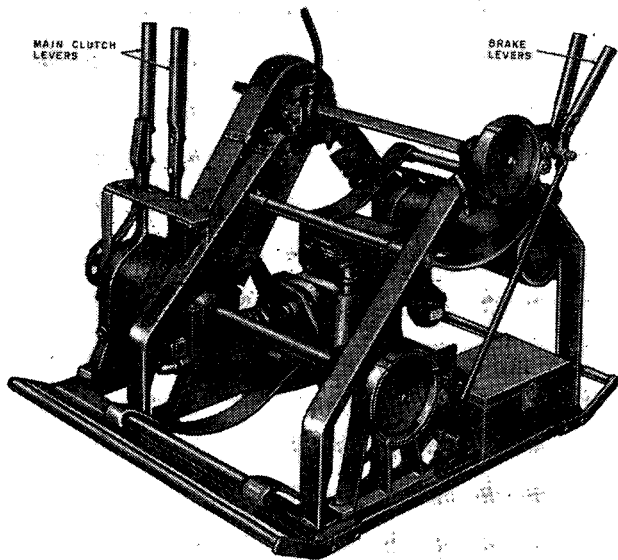

FIG-22

Figure 48. Reel Unit RL-26().

from both simultaneously. Brakes are provided to prevent backlash.

b. A small gasoline engine provides power to recover wire on either reel or both simultaneously. The reel unit can be operated by a hand crank when necessary.

c. More complete details on the operation and maintenance of the unit can be found in TM 11-360.

35. Wire Pike MC-123

Wire Pike MC-123 (fig. 49) consists of a two-section pole joined by a metal fitting and pin. The top

section terminates in a hook connected to a roller. This hand tool is used by a wireman during vehicular wire-laying and wire-recovery to guide the field wire to the side of the road and to provide a smooth drag in picking up wire.

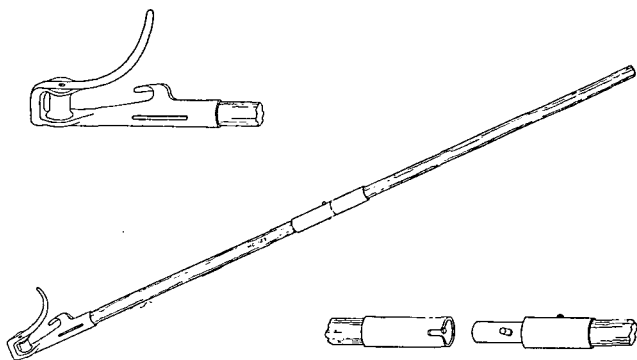

FIG - 29

Figure 49. Wire Pike MC-123.

CHAPTER 5

POLE AND TREE CLIMBING

Section I. CLIMBING EQUIPMENT

36. General

Climbing equipment (fig. 50) allows wiremen to climb poles or trees without the aid of pole steps or ladders and permits the hands to be free for performing work while aloft.

37. Climbers LC-240/U

a. General. Climbers LC-240/U (fig. 51) are adjustable, lightweight, metal climbers. The length of

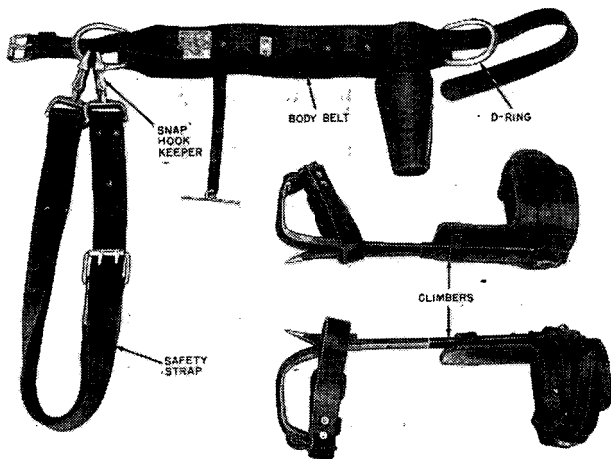

Figure 50. Climbing equipment.

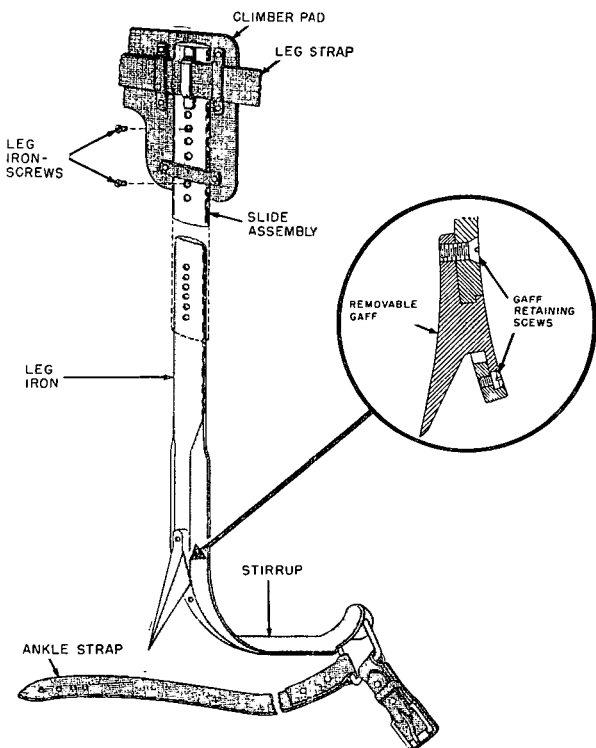

FIG-75

Figure 51. Climbers LC-240/U.

the climbers can be adjusted from $14\frac{3}{4}$ inches to $19\frac{1}{2}$ inches to conform to different leg sizes. Climbers LC-240/U consist of two leg irons, 2-inch and 3-inch interchangeable gaffs, leather fastening straps, and climber pads. The 2-inch gaffs are used for climbing poles or trees with thin bark; the 3-inch gaffs are used for climbing trees with thick bark.

b. Adjustment. Adjust the leg irons as follows: unscrew the two leg-iron screws and move the slide assembly on the leg iron to the desired length. Replace and tighten the two leg screws in the nearest screw holes.

c. Gaff Removal. Remove each gaff as follows: unscrew the two gaff retaining screws. Slide the gaff downward toward the stirrup and lift the gaff out of the retaining slot. The gaffs are replaced in the reverse manner.

d. Gaff Sharpening. At present, no gage is available to check the gaffs of Climbers LC-240/U. However, a new unused gaff may be used as a guide when sharpening dull gaffs.

38. Climbers LC-241/U

Climbers LC-241/U are adjustable metal climbers designed primarily for use in arctic climates. The stirrup is made slightly wider to permit the use of arctic boots. The length of the leg irons are adjustable from $15\frac{1}{2}$ inches to $18\frac{3}{4}$ inches.

39. Modified Climbers

a. General. Pole Climbers LC-243/G and Tree Climbers LC-244/G are modified versions of the old model climbers (Climbers LC-5 and LC-218/P). The length of these modified climbers are adjustable from $14\frac{3}{4}$ inches to $19\frac{1}{2}$ inches by changing the position of metal sleeve.

b. Care of Climbers. The climbers should be examined for broken or loose gaffs and for defective straps or pads. The gaffs should be sharp and have the proper dimensions. A gaff gage (fig. 52) must be used to measure important gaff dimensions.

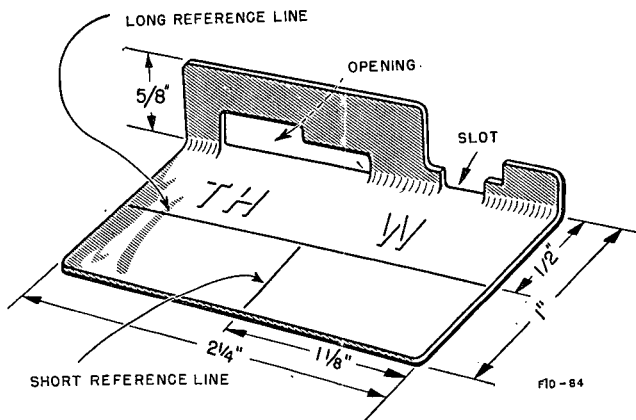

Figure 52. Gaff gage.

c. *Use of Gaff Gage TL-144.* The gaff climbers are checked as follows:

- (1) *Thickness.* Insert the gaff through the small opening marked TH as far as possible, with the inner surface of the gaff resting against the lined face of the gage (A, fig. 53). If the point of the gaff does not extend beyond the reference line, the thickness of this section of the gaff is satisfactory. Insert the gaff through the large opening marked TH as far as possible, with the inner surface of the gaff resting against the lined face of gage (B, fig. 53). If the point of the gaff does not extend beyond the far edge of the gage, the thickness of this section of the gaff is satisfactory.
- (2) *Width.* Insert the gaff through the small slot marked W as far as possible, with the

inner surface of the gaff resting against the lined face of the gage (C, fig. 53). If the point of the gaff does not extend beyond the long reference line, the width of this section of the gaff is satisfactory. Insert the gaff through the large slot marked W as far as possible, with the inner surface of the gaff toward the lined face of the gage (D, fig. 53). If the point of the gaff does not extend

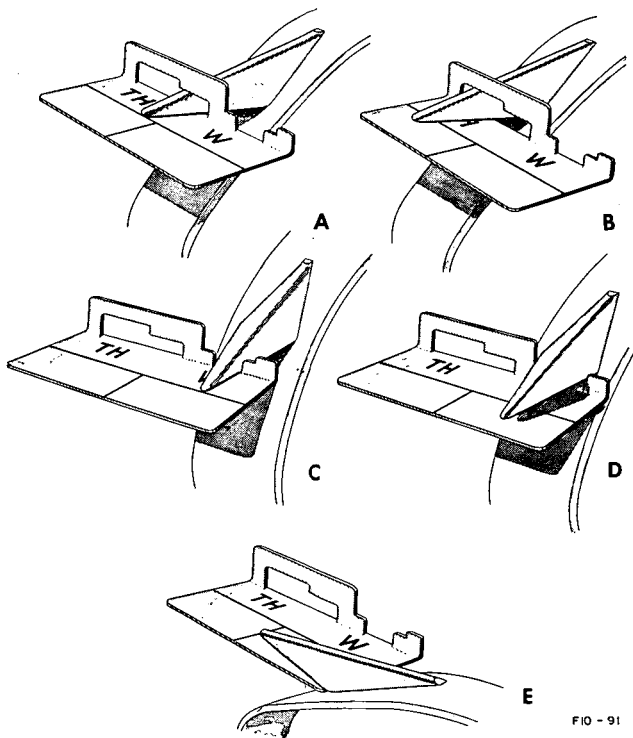

FIG - 91

Figure 53. Checking gaff with gaff gage.

beyond the far edge of the gage, the width of this section of the gaff is satisfactory.

- (3) *Length.* Place the lined face of the gaff gage against the inner surface of the gaffs, with the nearest edge of the gage tight against the leg iron (E, fig. 53). If the point of the gaff extends to or beyond the short reference line, the length of the gaff is satisfactory.
- (4) *Sharpening.* When sharpening a gaff, be sure to maintain the original shape as nearly as possible.

40. Lineman's Belt LC-23-()

a. General. Lineman's Belt LC-23-() consists of a leather belt and an adjustable leather safety strap (fig. 50). The body belt is supplied in various sizes. The size is determined by the distance in inches between the D-rings. Safety straps are furnished in 61-inch, 68-inch, and 70-inch lengths.

b. Care of Leather. Keep the leather clean, soft, and pliable by use of saddle soap or by lather from a neutral soap (such as castile). This removes embedded dirt and perspiration which rots the leather. Wipe the leather dry and apply a leather dressing (solution of one part water and one part mildew preventive—Paranitrophenol Fungicide). Do not use mineral oil or grease. Do not stand near an open fire while wearing leather equipment. Clean and dress leather parts frequently if the parts become wet or contact paint. Always remove paint as soon as possible. Examine the leather for cracks and pliability as follows:

- (1) *Safety straps.* With the smooth side (grain side) out, bend the straps over a round object not less than three-fourths of an inch in diameter. Make the test in at least three places (near both ends and in the middle of the strap). Slight cracks will normally appear on the surface.
- (2) *Body belts.* Bend at any points capable of being bent without great effort (such as under the leather tool loop and tongue strap). Do not bend belts over too small an object since this can cause damaging cracks. Always keep the grain side of the belt on top when bending the leather.

Caution: Never attempt to bend very dry leather.

41. Wearing Climbing Equipment

a. Climbers. The climbers should be adjusted to a length which is generally one-half inch less than the distance from the arch of the foot to the small bone projecting from the lower inner side of the kneecap. Straps should be fastened snugly around the calf and ankle.

b. Body Belt and Safety Strap. On a correctly fitted body belt, the **D**-rings will be just behind the projecting portions of the wearer's hipbones. The body belt is worn over the hips, loose, but tight enough to prevent slipping (figs. 54 and 55). If the wearer is right-handed, both ends of the safety strap are snapped to the left-hand **D**-rings; if left-handed, the ends are snapped to the right-hand rings. The double end of the strap is snapped to the **D**-ring with

the keeper toward the rear, and is kept hooked at all times. The fixed end of the strap is snapped on the D-ring with the keeper toward the front and above the snap hook of the double end. Before attempting to climb a pole, always adjust the length of the safety strap. To do this, engage the gaffs of the climbers near the base of the pole. Pass the safety strap around the pole and fasten the strap. Carefully lean back until the weight is supported by the safety strap. When the safety strap is adjusted properly, the palms of the hands should rest on the far side of the pole without any overlapping of the fingers.

c. Precautions.

- (1) *On the ground.* Be careful at all times when wearing climbers; gaffs can cause serious wounds. When wearing climbers, be careful not to step on your own feet or the feet of others. *Wear climbers only while climbing and working on poles or trees.* The habit of wearing climbers while working on the ground or riding in a vehicle frequently results in serious injury.
- (2) *Aloft.* While aloft on a pole or tree, always use the safety strap (par. 45) not only to minimize the danger of falling but also to allow you to work with minimum fatigue. Be careful not to drop tools or other equipment.
- (3) *Before climbing.* Beginners should practice fastening and unfastening the safety strap close to the ground until sufficient practice enables them to perform this step safely with speed and precision.

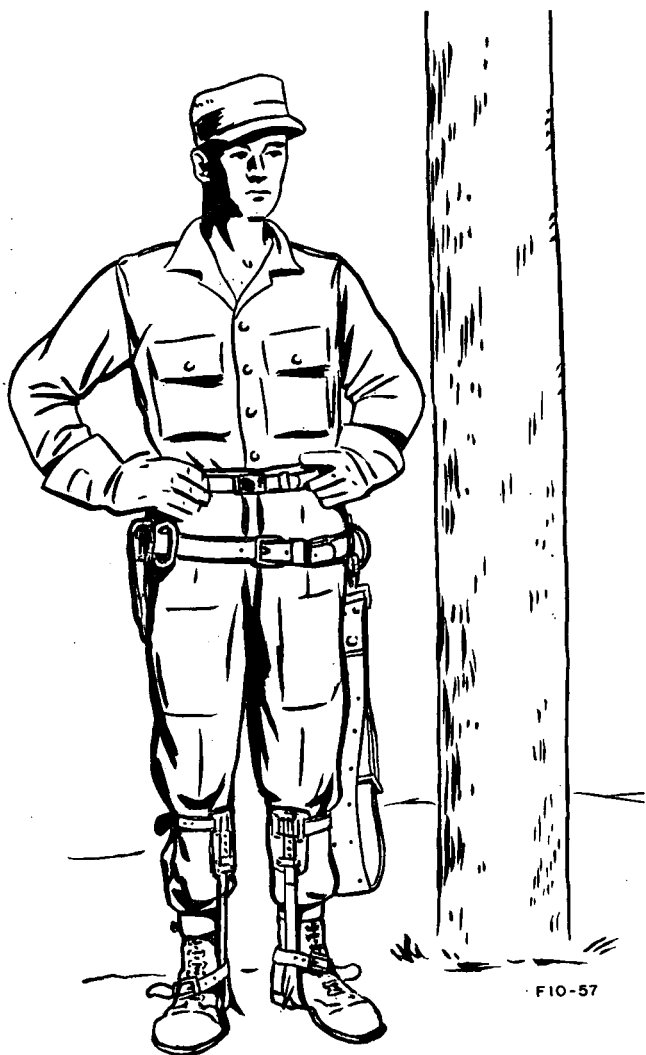
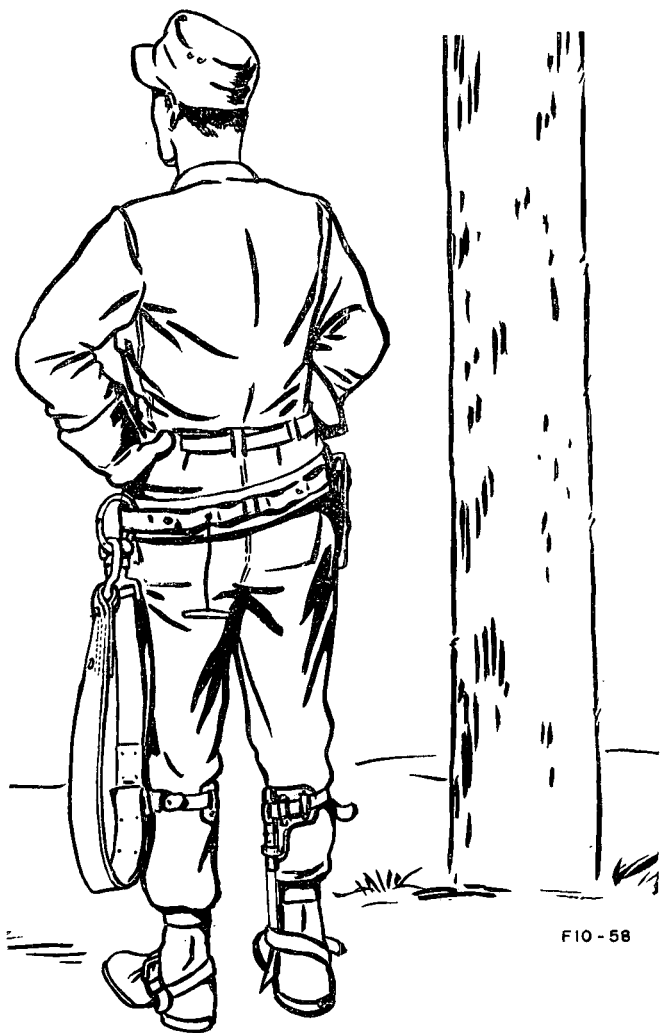

Figure 54. Wearing climbing equipment, front view.



F10-58

Figure 55. Wearing climbing equipment, rear view.

Section II. POLE CLIMBING

42. Safeguards

a. Poles that have been in service for long periods of time might be defective, and could break under unbalanced loads due to the weight of a lineman climbing or working aloft. Always inspect or test the pole before climbing it. Rig temporary supports to any pole that you suspect as being defective. Generally, a well-guyed pole may be climbed without testing. However, take no chances—test it before climbing.

b. The soundness of a pole can be tested by gently rocking the pole back and forth in a direction at right angles to the lines. This can be done with pike poles or by placing a length of field wire or rope above the center portion of the pole with a lance pole or sapling. A defective pole will crack or break.

c. Do not rock the pole if there is danger of having the pole cause damage if it should fall. The pole can also be tested for soundness by jabbing the butt of the pole at a point several inches below the ground line with a screwdriver or pick. This test will reveal rotten wood if the pole has commenced to decay at that point.

d. When working in the vicinity of power lines, follow all rules relating to power line clearances (par. 67*c*). Always assume that any metallic portion of the power line is alive with dangerous voltage. Do not rock a telephone pole to make a soundness test if there is danger of having the swaying telephone wires contact the power line.

43. Preliminary Instructions

a. In the following text, it is assumed that the wireman is right handed. A left handed person would perform the operations with the opposite hand and leg.

b. In climbing a pole, keep the arms slightly bent, with the hips away from the pole. To engage the gaffs, whether ascending or descending, thrust the legs sharply inward and downward. To disengage the gaffs, move the legs sharply upward and outward. Place the hands on the far side of the pole. Do not have the hands overlap. Placing the hands on the sides of the pole will cause unnecessary strain on the arms. Remember that the weight of the body is carried entirely on the gaffs—the arms merely balance the climber. Keep the body away from the pole. If the hips are too close to the pole, the legs will not angle inward to the pole. This could cause gaffs to cut out (loss of footing). If the hips are too far out, the arms are placed under the strain of supporting a large portion of the climber's weight. If the knees touch the pole, the gaffs will probably cut out. Keep the toes pointing upward.

44. Ascending

a. Before climbing, circle the pole and inspect it for soundness; also note the location of wide weather cracks and soft or hard spots in the wood. Look for any cables, cross arms, or other obstruction that may interfere with climbing. If the pole leans, face the direction in which the pole is leaning and climb on the high side.

b. Grasp the pole and raise the left foot about 10 inches from the pole. With a downward thrust,

jab the gaff of the climber into the face of the pole at a point about 8 inches from the ground (fig. 56).

c. Lift the weight of the body on the gaff by straightening the leg. While the weight of the body is on one leg, keep the knee straight and away from the pole. Raise the other leg and corresponding arm and drive the gaff downward and inward to seat it firmly (fig. 57).

d. The gaff is disengaged by a sharp upward and outward motion of the leg. In taking the next step, raise the left leg and left arm (or right leg and right arm) together. The body should not sway excessively.

e. Reengage the free gaff firmly and continue climbing to the desired height. While ascending, always look up and avoid any possible obstructions.

f. Whether ascending or descending, the gaffs should travel in a path on the face of the pole approximately $4\frac{1}{2}$ inches apart. This may vary slightly depending on the size of the climber.

45. Fastening Safety Strap

To fasten the safety strap when the desired height on the pole has been reached, proceed as follows:

a. Shift the weight to the left foot and engage the right gaff at a slightly higher level than the left gaff.

b. Place the right hand around the pole (fig. 58). With the thumb of the left hand, open the keeper on the snap hoop and shift the fixed end of the safety strap around the pole to the right hand.

c. Transfer the snap hook and strap to the right hand (fig. 59) balancing the body with the left hand.

d. Loosely support the strap on the pole at about

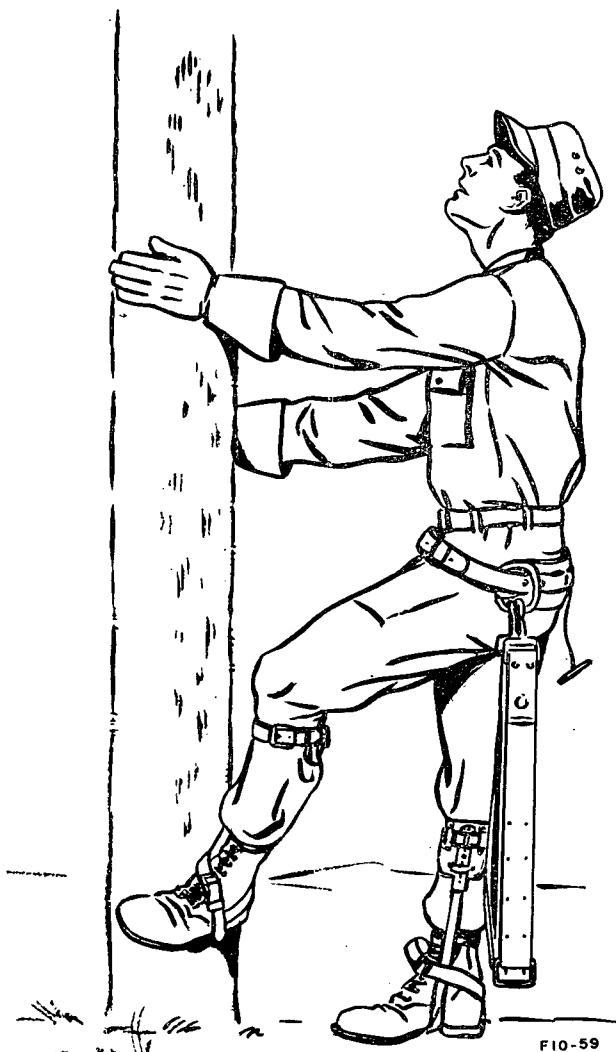

F10-59

Figure 56. Beginning the climb.

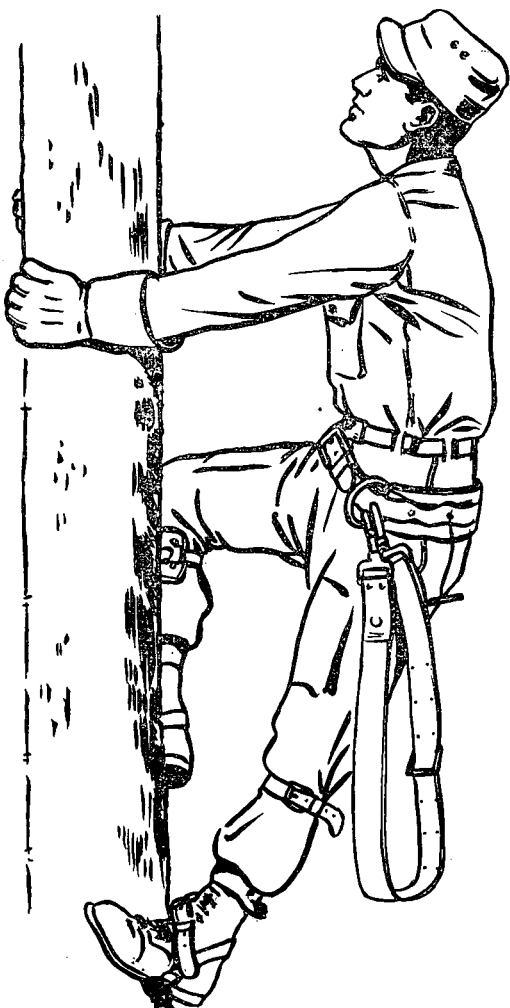
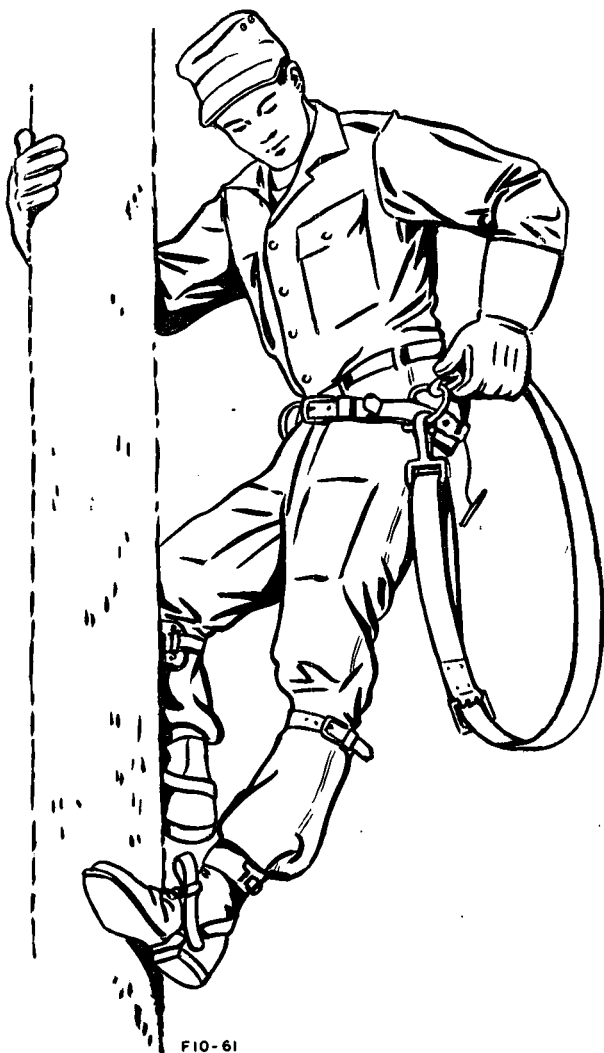

FIG-60

Figure 57. Climbing.



F10-61

Figure 58. Unhooking safety strap.



F10-62

Figure 59. Transferring safety strap to right hand.

the proper height and with the right hand. Pull the strap around to the right hand D-ring. Snap the hook on the D-ring with the heel of the right hand (fig. 60).

Caution: It is essential to see that the snap hook is properly engaged. *Do not assume*, merely from the snap of the keeper, that the D-ring has been engaged by the snap hook.

e. Lean back, carefully placing the full weight of the body on the safety strap, adjust body position and feet to take up a comfortable working position (fig. 61).

46. Working Aloft

a. When working aloft on a pole, the safety strap is never placed within 12 inches of the top of the pole or above the top cross arm. To reach the outer right insulator (fig. 62), hook the safety strap below the cross arm. Place the right foot slightly lower and to the side of the pole. Straighten the right knee. Lean out and slip your head and shoulders between the conductors. To reach the outer left insulator, reverse the above procedure. (Frequently, the length of the safety strap must be adjusted to allow the climber to reach the end of a long cross arm. If this is the case, adjust the safety strap before ascending.)

b. When circling a pole to the right, thrust the right gaff slightly lower and to the right side of the pole. (Take small steps.) Stiffen the knee and shift the body to the right, disengage the left gaff and thrust close to and slightly higher than the right foot. A slight twist of the hips will equalize

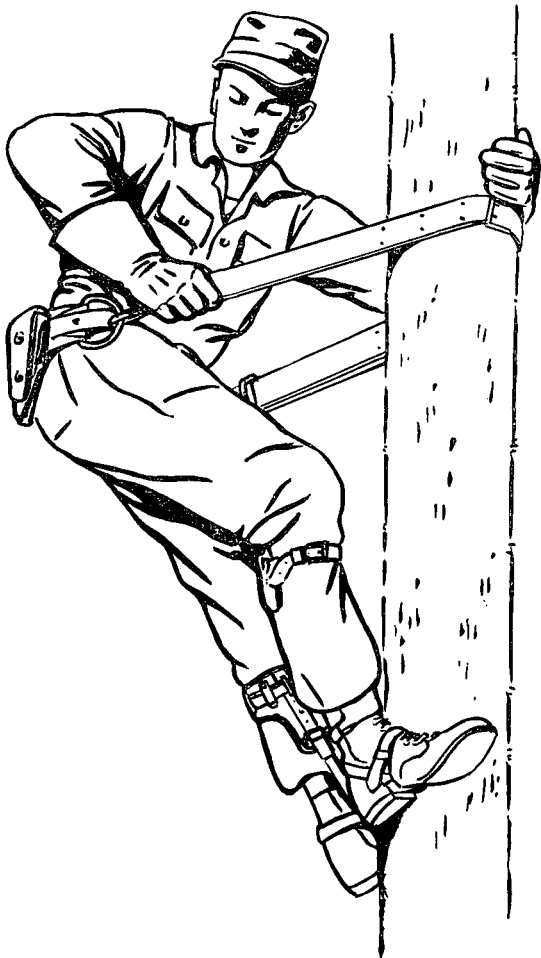

FIG-63

Figure 60. Snapping hook on D-ring.



F10-64

Figure 61. Setting into working position.

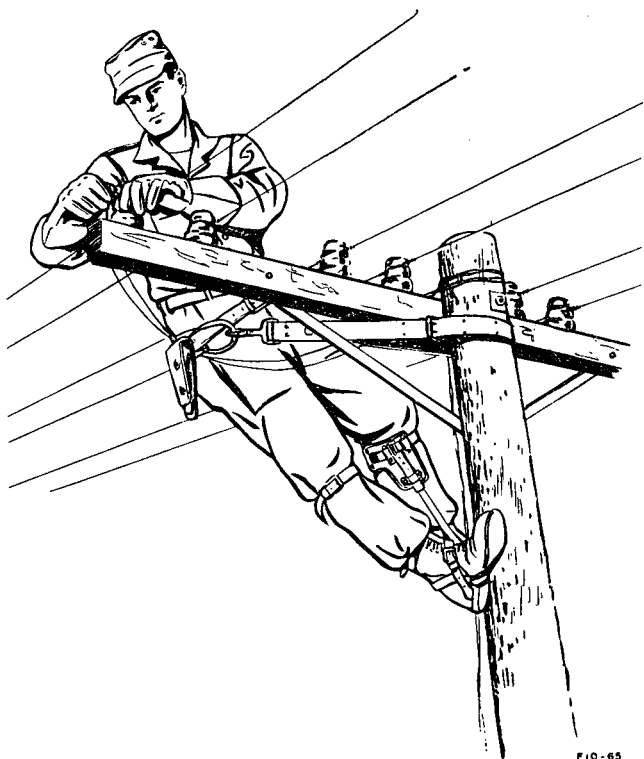

FIG-65

Figure 62. Tying field wire on outer insulator of cross arm.

the length of the safety strap. Continue in this manner until the desired position is reached. To circle left, the above procedure is reversed. (Practice circling the pole close to the ground until confidence and efficiency are gained.)

47. Unfastening Safety Strap

To unfasten the strap, reverse the procedure described in paragraph 45.

a. Move the right gaff up and reengage it at a slightly higher level than the left gaff. Grasp the pole with the left hand. With the right elbow up, the hand twisted, and the thumb held downward, depress the keeper and disengage the snap hook from the right-hand **D**-ring.

b. Pass the strap around the pole to the left hand, balancing the body with the right hand. Snap the hook to the left-hand **D**-ring with single downward movement.

48. Descending

Descend the pole as follows: take a small step up with the right foot, unsnap the safety strap, and reconnect it to the left **D**-ring. Disengage the right gaff. Stiffen the right leg, keep the toes pointing upward, take a long downward and inward step, and drive the gaff into the pole. The right knee should now be approximately opposite the left heel. Disengage the left gaff and, in the same manner, take a downward step with the left leg. The right arm is moved with the right leg and the left arm is moved with the left leg whether ascending or descending. Continue to descend, looking down to avoid any obstructions or defects on the pole.

Section III. TREE CLIMBING

49. Safeguards

Before climbing trees, remove all dead wood, branches, or any other material at the base of the tree that may hinder or cause injury to the climber. Inspect the firmness and thickness of the bark. Remove all twigs and small branches in the way of

the climber. Guard the eyes and face when working in trees. Do not stand on limbs that are not strong. Avoid touching any poisonous plants.

50. Methods

a. To climb trees, use climbers fitted with tree gaffs and proceed in the manner described in paragraphs 42 through 48.

b. Trees having large diameters generally are more difficult to climb than smaller trees, and usually require some variation in the method of climbing. The safety strap is normally long enough for trees with diameters up to 24 inches. When climbing larger trees, it may be necessary to substitute a rope for the safety strap. Two safety straps may be linked together if the combined length is sufficient to pass around the tree trunk.

CHAPTER 6

FIELD-WIRE LINE CONSTRUCTION

Section I. PLANNING

51. General

The construction of field-wire lines requires planning prior to the actual installation. In planning, consideration should be given the following: the availability of material, the number and type of circuits required, the length of the line, and time permitted for the installation.

52. Types of Construction

When the circuit requirements have been determined, consideration must be given to the type of construction needed. This can be aerial, surface, or underground construction.

a. Aerial Construction. An overhead line generally provides the most satisfactory type of construction. Aerial construction is easiest to maintain or change, and provides better quality circuits than surface construction (*b* below). However, aerial construction requires more time to install, is visible, and therefore, vulnerable to enemy action, and is subject to the effects of storms and weather.

b. Surface Construction. Wire lines laid on the ground provide a rapid method of installing wire lines with a minimum of materiel. Surface con-

struction is extremely vulnerable to damage by foot troops and vehicles. Wire lines laid rapidly on the ground without regard for proper construction practices usually require immediate and continuous maintenance and are, therefore, seldom justified. However, carefully installed wire lines provide reliable circuits which are suitable for most combat requirements.

c. Underground Construction. Extensive underground construction is rare in forward areas. Buried wire lines are not affected much by temperature and weather. Field-wire lines are often, for this reason, buried to stabilize the electrical characteristics of the circuits. An underground installation generally is not as flexible as an aerial installation. For example, adding one circuit involves the same work as installing the original line. Maintenance is also troublesome since the lines have to be dug up for repairs; and testing points are not readily accessible. Another disadvantage is that buried wire usually is not reusable because of the likelihood of damage during wire recovery.

53. Selection of Line Routes

a. The selection of a communication line route is based on the requirements of the tactical situation, and on a map study supplemented by ground reconnaissance. The most direct and practical route should be chosen with due regard given to accessibility for construction and maintenance. Topographical maps and aerial photographs of the area can be effectively used to indicate several possible routes, as well as the difficult terrain to be avoided, such as

forests, rivers, swamp lands, sudden changes in grade, and very rocky areas. If the line is to go through a populated area, the map or photo reconnaissance should indicate railways, streets, buildings, and power lines. Always select a route which avoids exposing the linemen to electrical or physical hazards. The resulting pictures from a photographic survey can be used to prepare line route maps for construction and maintenance purposes.

b. Several alternate routes should be planned from a map supply. The final selection should be made after preliminary ground reconnaissance has been made to determine the type of construction needed and the best possible route. Where there is a possibility that the initial installation will become permanent; choose the route so that future changes can be made easily. Avoid industrial or built-up residential areas where possible. Wire construction is difficult in these areas both to install and maintain and, in addition, invites sabotage in occupied territories. Use cross-country routes or secondary roads when possible. These routes minimize interruptions caused by friendly vehicular traffic, aerial bombardment, and artillery fire. When laying wire, always take precautions against mines and booby traps. The line route selected should provide concealment and cover from hostile observation and fire to minimize the hazards of constructing and maintaining wire lines.

54. Construction Centers

a. A construction center is an installation erected at the point where trunk and long-local wire lines

converge before entering a terminal center, such as a telephone central. Construction centers are located near, or in, command post areas. The construction center is set up to facilitate wire-line installation and maintenance. It also relieves the switchboard operator at a command post from assisting the wiremen during the installation or trouble shooting of a wire line. In some units, these centers are referred to as *wire heads* or *zero boards*. However, wire heads or zero boards form only part of a complete construction center. The construction crew is dispatched from a construction center. For this reason, the center should be located at some distance from the command post telephone central to eliminate unnecessary vehicular traffic in the area.

b. A wire head is the point where all wire lines enter and leave the construction center. The zero board is either a group of terminal strips (boxes) or switchboards used to terminate and test wire lines which are under construction. It also enables wiremen to conduct routine tests of operating lines and to trouble shoot or test faulty lines without interfering with the switchboard operators at the telephone central.

c. A communications control center (vehicular) is a mobile installation which provides patching and interconnection of various long distance operating circuits to meet existing traffic requirements. It serves as a component of complete mobile communications systems, functioning as a system control center.

55. Use of Aircraft to Lay Field Wire

Both the fixed-wing and rotary-wing army aircraft can be used to lay Wire WD-1/TT over rough or mountainous terrain, gullies, slopes, streams, thickly wooded or jungle areas, and other hazardous or inaccessible locations. The rotary-wing aircraft, within its altitude limitations, is the more suitable of the two types of aircraft for wire laying because of its superior maneuverability, slower flying speed, and its ability to hover over a point. Wire laid by aircraft cannot be expected to remain in service any appreciable time unless the wire line is immediately policed by a wire team on the ground. For additional information, see TM 11-2240.

56. Designation of Lines and Circuits

a. The method of marking and identifying wire lines and circuits is given in the signal operation instructions (SOI) and the standing signal instructions (SSI) of an organization. See paragraph 57*c*.

b. Circuits are designated by individual circuit number, by name, or by a combination of the two. For example:

101-36

Dexter-Dobo

Dandy-A

For the individual circuit number given above, 101 represents the circuit number, and 36 represents the code designation of the installing organization.

c. The circuit designation remains the same from the point of origin to the final terminal of the circuit, regardless of the number of test stations that it may pass through. Tagging field-wire lines is a

method used to identify a field-wire circuit. Correctly identified wire lines speed up equipment installation and wire-line maintenance.

d. No two cables or lines that are constructed by the same organization during a single operation are given the same number.

57. Tagging of Field Wire

a. Importance of Tagging. Tagging of field-wire lines is regarded as an essential item of good construction. Tags often form the only method of distinguishing one line from another. Tagging simplifies the turning over of wire systems to relieving units; makes line tracing easier, especially in darkness; and simplifies maintenance. If tags normally issued as a field item are not available, a unit is expected to improvise substitute tags. Every unit is responsible for insuring that its lines are adequately labeled.

b. Points to be Tagged. During wire laying, lines are tagged and attached at the following points:

- (1) Overhead wire route crossings.
- (2) Trench wire route crossings.
- (3) Crossings at roads, trails, trolley and railroad tracks, railroad junctions, and bridges.
- (4) Communication centers (inside and outside).
- (5) Telephones, repeaters, switchboards, and test terminal points.
- (6) Both sides of buried or overhead crossings.
- (7) Where the wire-laying or construction techniques changes from:
 - (a) *Surface to underground.*

(b) *Surface to overhead.*

(c) *A point at which a wire line branches off the main route.*

(8) Frequent intervals where several lines are laid along the same route.

(9) Possible future trouble spots along a route.

c. *Shape, Material, and Marking of Tags.* An oblong-shaped tag made of moistureproof and weatherproof material must be used. Tags are cut, notched, colored, or marked in accordance with the SOI or SSI issued by the organization or unit headquarters. The markings must not disclose the identity of the unit or organization. Examples of some of the cuts, notches, and markings which can be employed are given in figure 63.

d. *Fixing of Tags.* Tags must be securely fixed to the line. At points where all lines are tagged (such as test terminal points), tags should be arranged in oblique or staggered rows to avoid having the tags obscure one another.

Section II. ORDERS AND RECORDS

58. Construction Orders

Construction teams, trucks, and equipment are organized on the basis of information obtained from a reconnaissance. Construction orders should prescribe the number of circuits to be installed, the priority of the installation, the time when each of the various circuits must be completed, and the action to be taken upon the completion of the installation. The following information should be given by line route maps and tactical circuit diagrams, supplemented by oral or written instructions:

EXAMPLES OF CUTS, NOTCHES, AND
MARKINGS ON TAGS

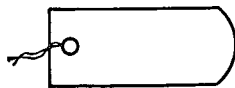
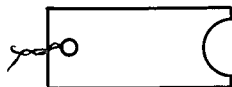
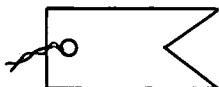
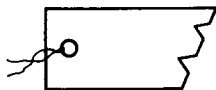
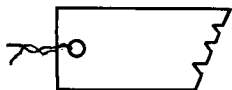
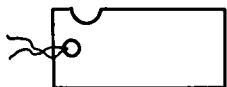
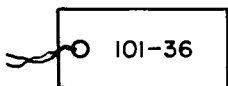

F10-100

Figure 63. Examples of cuts, notches, and markings on tags.

Circuit number

Route

Type of circuit:

 Trunk or local

 Metallic or ground return

Approximate length

Type of construction

Nature of roads and terrain

Switching centrals to which the circuit will connect

Number of test stations

Necessary precautions

Tests and reports required

59. Field-Wire Construction Teams

Field-wire construction teams are composed of sufficient wiremen and wire construction equipment to allow the teams to operate as self-contained units. The vehicles used by these teams are equipped with wire-laying and other wire construction equipment. In addition to installing field wire, these teams police the lines, perform routine maintenance, and recover and service field wire. Fewer personnel and smaller vehicles are required for policing wire lines and troubleshooting than for wire laying.

60. Line Route Map

a. A line route map can be a map or map overlay that shows the actual or proposed route of wire lines (fig. 64). Line route maps are used to designate the physical location of wire lines, switchboards, switching centrals, test stations, the number of circuits along the route, and the types of wire construction.

Line route maps do not show the actual connections or type of equipment at switching centrals and test stations.

b. An overlay must be referenced to the map from which it was prepared. The overlay must show at least two orientation points taken from the original map. The line route map should contain only those lines, symbols, and notations that are necessary for its purpose.

c. For explanation of symbols used in line route maps, refer to appendix III.

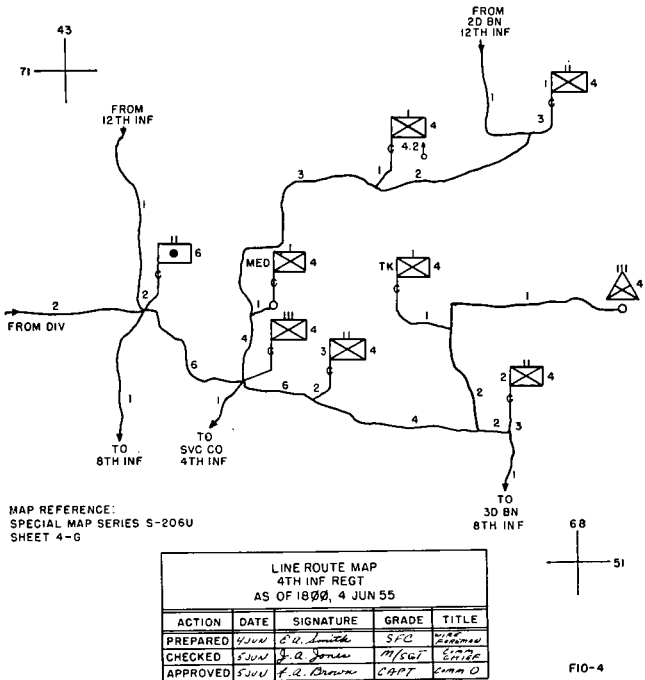

Figure 64. Example of line route map.

d. Local security measures will determine the amount of information that will be shown.

61. Tactical Circuit Diagram

a. Tactical circuit diagrams (fig. 65) are line drawings which use symbols to illustrate the arrangement of tactical wire communication networks. These diagrams usually show the following:

- (1) Military units, activities, and installations served by the wire net.
- (2) Switching centrals, wire terminal and repeating facilities, and test stations.
- (3) Identification and description of interconnecting circuits.
- (4) Radio relay systems forming part of a wire network.
- (5) Connecting circuits into or through switching centrals and test stations.
- (6) Information pertaining to a unit designation and location (if permitted by security measures).

b. For explanation of symbols used in circuit diagrams, refer to appendix III.

62. Security

Complete maps and diagrams must not be carried into forward areas because of the danger of having the enemy seizing and compromising the information. Individual construction and maintenance teams are issued only such extracts of the maps or diagrams that permit the proper performance of their specific mission. Such extracts should not show unit designations.

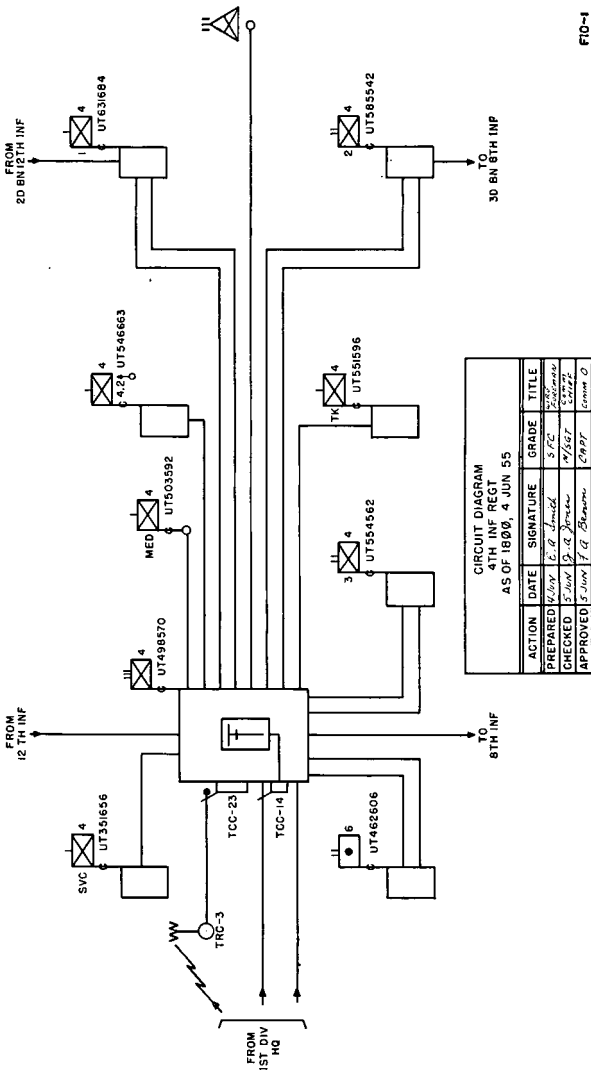

FIG-1

Figure 65. Example of tactical circuit diagram.

Section III. FIELD-WIRE CONSTRUCTION TECHNIQUES

63. Preparations in Laying Field Wire

a. Before starting field-wire construction, a reconnaissance of available routes should be made and the following features noted:

Number of overhead crossings.

Number of underground crossings.

Number of railroad crossings.

Number of streams or river crossings.

Type of terrain.

Type of construction best adapted to available wire-laying equipment.

Distances in miles.

Concealment for wire parties during construction and maintenance.

Obstacles to maintenance.

b. The next procedure is to select and clearly mark on a map the exact route along which the wire is to be laid. Select the route that meets the requirements of the tactical situation, and along which a line would be least difficult to construct and maintain.

c. Always test and service field wire before placing it in use. Check for opens, shorts, faulty insulation, and poor splices.

64. Constructing Surface Lines

a. While units are on the move in combat, field-wire lines are usually laid on the ground. Surface lines must be protected against damage from both foot and vehicular traffic at command posts, road and railroad crossings, and other places where the wire lines cross traffic lanes. Lay surface lines loosely,

leaving plenty of well-distributed slack along the line. Slack allows the line to lay flat on the ground, and simplifies maintenance and construction changes. At suitable intervals, tie the surface lines to the base of trees, posts, or stakes. This prevents passing troops and vehicles from pulling the wire into traffic lanes. Make the ties to trees or posts at the ground level (fig. 66). When surface lines are routed along

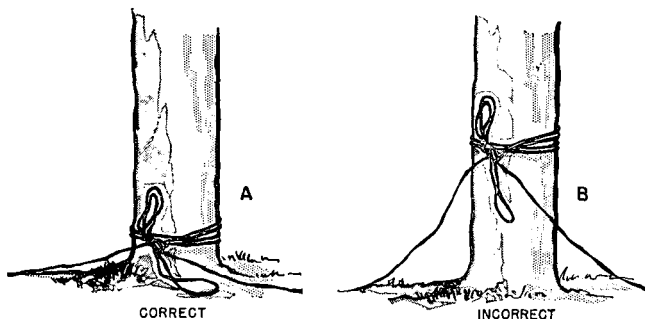

FIG-37

Figure 66. Tying surface lines on trees or posts.

a road, the wires must be kept well off the traffic lanes. When the road curves, route the line along the inside edge of the road to avoid making a large number of ties. Test the installed wire line back to the construction center before splicing on an additional reel of wire.

b. The wire lines at the beginning and the terminating points should be tied to some fixed object leaving sufficient slack or lead-in wire to reach the switchboard at the command post on the zero board in the construction center.

c. The wire lines should be tested again after being laid to the designated point. Perform an operational test after the line has been connected to the terminal equipment.

d. Tag all wire lines as described in paragraphs 57.

65. Wire Construction Across Roads

a. *General.* During a wire-laying operation, a line can be brought across a road in several ways: using an existing culvert or similar means; constructing an overhead line; and burying the line.

b. *Culverts.* The use of culverts is the fastest method for installing wire across a road. The wires are passed through the culvert, tagged, and tied at both ends of the culvert to prevent contact with water (fig. 67). Wrap the wires with tape at points of contact on the culvert to prevent damage to the insulation.

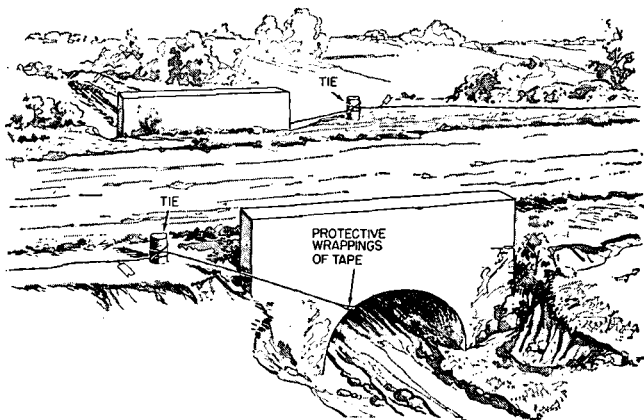

F10-42

Figure 67. Wire crossing road through culvert.

c. *Overhead Lines.* Overhead lines that cross main roads must have at least 18 feet clearance from the crown of the road. Lines at secondary roads must have at least 14 feet clearance. Overhead lines suspended from trees, poles, or other supports must be tied in at the ground level, as well as overhead. These lines should be tagged at the base of the support at both sides of the crossing. Use lance poles as supports if other means are not available.

d. *Underground Lines.* When there are no culverts and the use of overhead construction is not possible, lay field wire across a road by burying the lines in a trench (fig. 68). Dig the trench 1 to 2

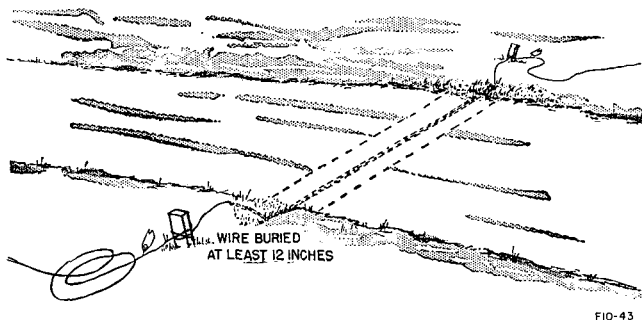

Figure 68. Wire crossing buried in trench across a road.

feet deep and at right angles to the road. The trench must extend at least 2 feet beyond each side of the road. Lay the wire loosely in the trench. Tag and tie the wires to a stake at each end of the trench. Do not place stones or sharp objects on the wire when refilling the trench. These objects could crush the wire insulation when passing vehicles cross over the trench. Leave a sufficient amount of slack on one

side of the road to permit replacement of the wire in the trench if it becomes damaged. Another useful technique is to place a spare wire in the trench with the working line. This spare line should also be tagged and tied to stakes with sufficient slack for splicing.

66. Wire Construction Across Railroads

When the field wire must cross railroad tracks, never make an overhead span crossing. High overhead crossings are permitted however, at locations where bridges or viaducts exist. Avoid making a crossing within railroad yards. Locate a point beyond the yards where the track crossing will be the shortest. Use a culvert or bridge if one is available in the vicinity even though the line must be detoured for a considerable distance. If neither a bridge nor culvert is available, lay the line *under* the tracks (fig. 69). In making the crossing, pull the wires

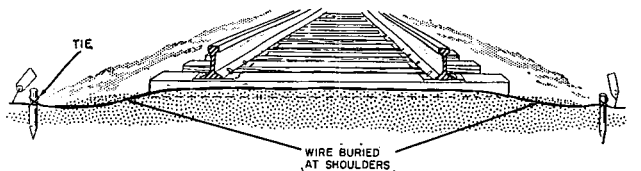

FIG-44

Figure 69. Wire crossing under railroad tracks.

taut and bury the wires from a point outside the rails to a point beyond the shoulders or improved strip along the tracks. Secure the wires on both sides of the track to prevent the wires from being pulled out by traffic along the tracks.

67. Constructing Overhead Lines

a. General. Field-wire lines should be placed overhead in and near command posts or other congested troop areas, along roadways at points where traffic is likely to be diverted from the road, and at main and secondary road crossings. Trees and existing poles are the most desirable supporting structures. The type of tie used at the crossing depends on the span length and local climatic conditions. At junctions between overhead and surface line construction, tag and tie the wires securely to the bottom support (fig. 70). In general, install test stations where long overhead lines make a junction with any other type of construction.

b. Sag in Line. Sag in the line is an important factor in the construction of overhead lines. Lines inadequately sagged are a constant source of trouble. The proper sag is determined by the storm loading area (heavy winds, snow, and ice), strength of the wires (tensile strength), temperature, and average span length. Normally, the sag remaining in the field wire after the wireman has drawn the wire up as tight as he can (using his arm strength alone) will meet the minimum sag requirements. A good rule of thumb is 6 inches of sag for every 25 feet of span length. When placing sag in the lines, always maintain a minimum road clearance of 18 feet across main roads and 14 feet across secondary roads.

c. Power and Light Distribution Poles. When power distribution poles are used for supports in overhead construction, the field-wire lines must, when practical, be tied at least *4 feet below* the power lines. This clearance should be increased to at least

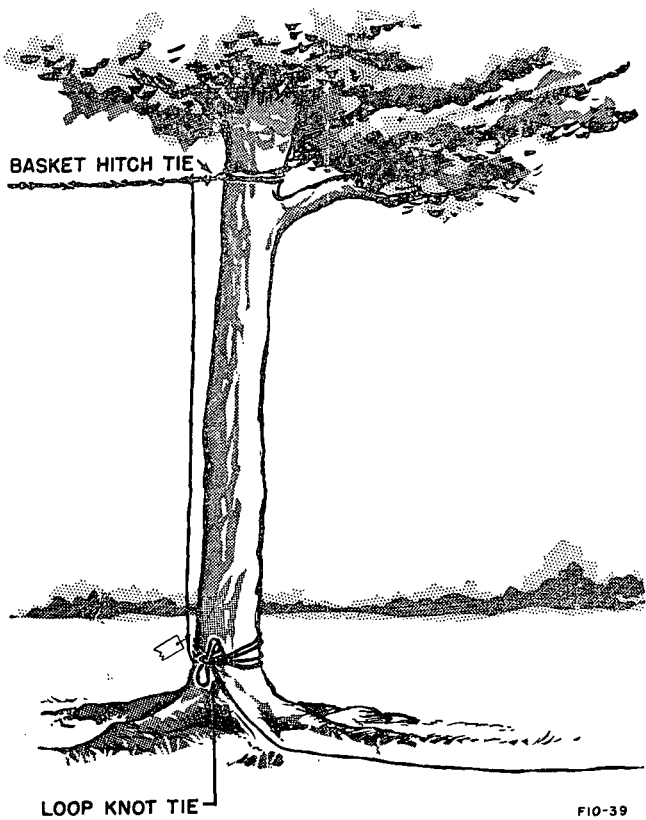

FIG-39

Figure 70. Method of tying wire at junction of surface line with overhead.

6 feet on very high-voltage lines. These clearances are required to prevent high inductive hum and induced voltages from interfering with communications, and as a safety precaution against the possi-

bility of contact between field wire and the power lines.

Caution: All electric light and power wires are always considered to be carrying dangerous voltage. Do not tie field-wire lines to transformer cases, electric light brackets, or power cross arms. Be extremely careful when working around power lines to prevent injury or death by electrical shock. Observe all safety precautions and follow safe construction practices.

d. Open-wire Pole Line. Field-wire lines should be tied about 2 feet below the conductors of an open-wire pole line. This clearance minimizes the possibility of inductive interference or contact between the field-wire and open-wire circuits.

68. Lance Pole Construction

a. General. When poles, trees, or other supports are not available, Lance Poles PO-2 provide a convenient method of supporting overhead lines. These poles are 14 feet long, 2 inches in diameter, made of wood, and tapered at the bottom. An insulator pin, threaded for Insulator IN-12, IN-15, IN-25, or IN-26, is attached to the top of the pole.

b. Construction of Wire Crossing at Main Roads. A wire crossing at a main road must have an 18-foot clearance (fig. 71). Since the lance pole is only 14 feet high, the additional length is obtained by lashing two poles together. When additional strength is required, two lance poles are lashed together at the base (fig. 72). Lash the poles with field wire or marline, overlapping the poles at least 5 feet. This

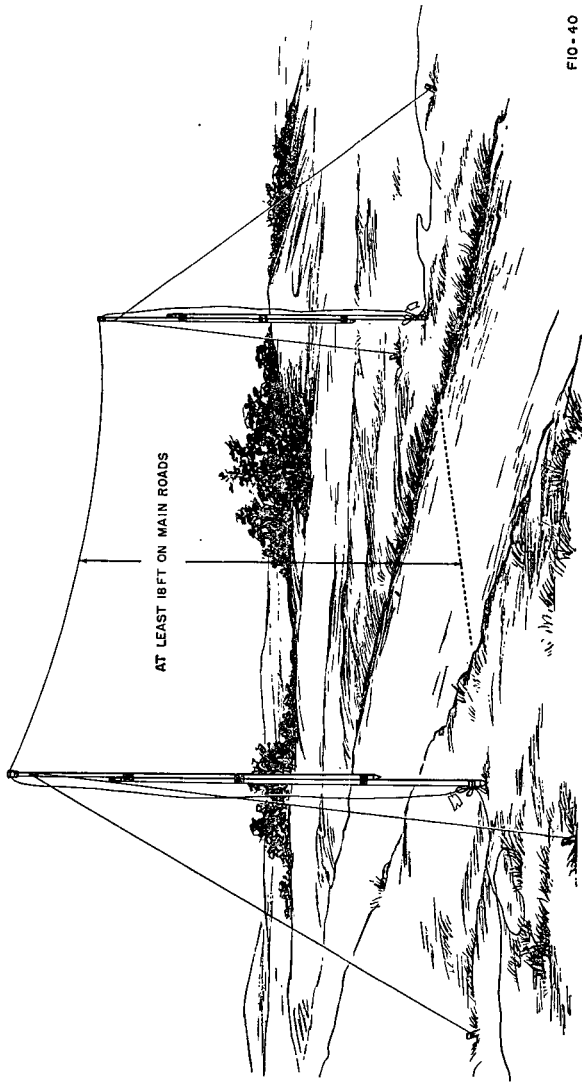

FIG - 40

Figure 71. Wire construction across roads, using lance poles.

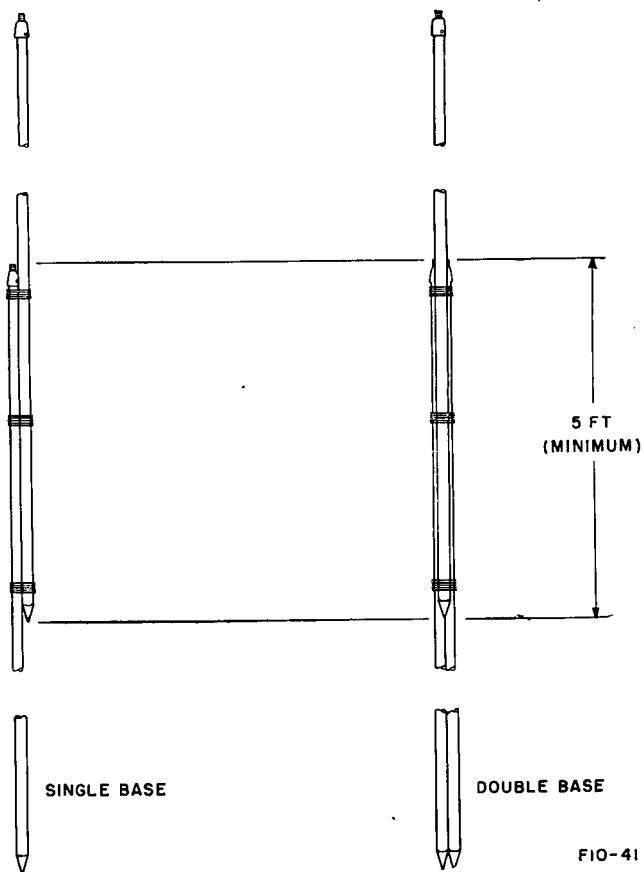

Figure 72. Lashing lance poles.

construction can support up to 10 field-wire lines for short spans.

c. Construction of Wire Crossing at Secondary Roads. A wire crossing at a secondary road must have a 14-foot clearance. Only two lance poles are required provided the shoulders of the road are sufficiently high off the road. If this minimum clearance cannot be obtained, additional lance poles must be lashed together as described in *b* above.

d. Guying and Line Wire Ties. Lance poles require adequate guying. Tie the guy wires (field wire is suitable for this purpose) and line wires to the lance poles before raising the poles. Use a clove hitch tie to fasten the wire line to the insulator pin. Where possible, lash the lance poles to firm posts or tree stumps; otherwise, guy each lance pole on both sides of the wire line. Usually, corner poles require only one guy. This guy should oppose the pull and be in line with the middle of the angle formed by the field wire at the corner. Tie one end of the guy wire near the top of the lance pole. Have the guy wire extend out at an angle of 45° from the pole, and fasten the free end to a stake or other support. Do not use any portion of a field-wire line as a guy wire. Figure 71 shows the proper method of tying a field-wire line at the start and finish of any lance-pole construction.

e. Construction of Straight Sections of Line. Long spans of field wire must be supported by side-guyed lance poles every 100 feet. Every tenth lance pole must be guyed by four guy wires. These poles are guyed to prevent the entire line from falling if the unsupported poles are knocked down. If these lines

are built in areas subject to heavy winds, snow, or sleet, reduce the distance between poles.

69. Wire Construction Across Rivers

a. General. A field-wire river crossing can be made using existing bridges, overhead spans, and submerged construction.

b. Use of Bridges. Where bridges must be used, attach the field-wire lines to the bridge in such a manner that the lines will not be damaged by traffic. When possible, form a multipair field-wire cable (par. 73) and attach the cable to the bridge supports below the bridge road surface.

c. Use of Overhead Construction. Small-stream crossings are made in the same manner as overhead road crossings, except that the wires need be only high enough to clear waterborne traffic. For long-span construction, field wire should be supported by a steel messenger cable. (See TB SIG 243.)

d. Submerged Construction. Field wire can be submerged to make a river crossing. The circuit quality and talking range of submerged wire decreases rapidly with the immersion time. Only unspliced field wire with perfect insulation should be submerged. Field wire should be tested carefully before and after an installation. In submerged construction, field-wire lines should be anchored at each shore point and weighted down in the water. This prevents the wire from being snagged by boats or floating objects.

70. Test Stations

a. General. Test stations are installed on a wire line to simplify the testing and rearranging of cir-

cuits. Test stations are usually located: at points where circuit diverge; at the end of a wire line that does not terminate in a switchboard; near points where circuits are most exposed to damage; at probable future locations of command posts; or at other convenient points along the line. A test station is usually given a geographic designation. The equipment used at these points is either Terminal Strip TM-184 (fig. 97) or Terminal Box TA-125/GT (fig. 95).

b. Construction of Test Stations. The site selected for a test station should afford concealment and cover from hostile observation and fire. It should be readily accessible for testing purposes. A test station consists of one or more terminal strips fastened to a tree, fence post, or other support (fig. 16). The wire circuits are tagged and tied before being connected to the binding posts. The circuits are connected in numerical order beginning at the top with the lowest numbered circuit. A test station can be installed after initial installation of the wire lines but this should be done without interrupting communication.

c. Removal of Test Stations. When a test station is to be abandoned, the usual practice is to leave the terminal strip (box) connected, although it may be removed and the circuits spliced through. The removal of test stations should be done without interrupting communications.

d. Conversion of Test Stations to Telephone Centrals. Command posts are often established at a former test station location. When converting a test station into a telephone central, it is important

that the wire lines be placed overhead or buried, and that the switchboard be set up as near the test station as possible to simplify the cutover. The terminal strips which were used at the test station could be utilized as a main distributing frame for the switchboard or serve as part of a construction center for a switching central. When the transfer is completed, the operator should check the circuits and notify the units concerned that the conversion has been completed.

71. Servicing Field Wire

After field wire has been recovered, it should be reconditioned (serviced) for reuse as follows:

a. Mount an empty reel on a reel unit and the reel containing the wire to be reconditioned on another reel unit. Position the reel units so that the wire may be wound on the empty reel from the full reel (fig. 73).

b. Pass the end of the wire through the holes provided on the drum of the empty reel. Secure one wire and allow the end to protrude from the side of the reel. This end is left free for future testing of the wire.

c. Station a man at each reel and another man between the reels to examine the wire as it is wound slowly on the empty reel. Tape each abrasion or break in the insulation as described in paragraph 8*f*. Carefully splice every break in the conductors. Untape and examine each old splice. Cut out each poorly made splice and resplice the wire properly. If the insulation has been damaged over a long section of the wire, or if there are several splices lo-

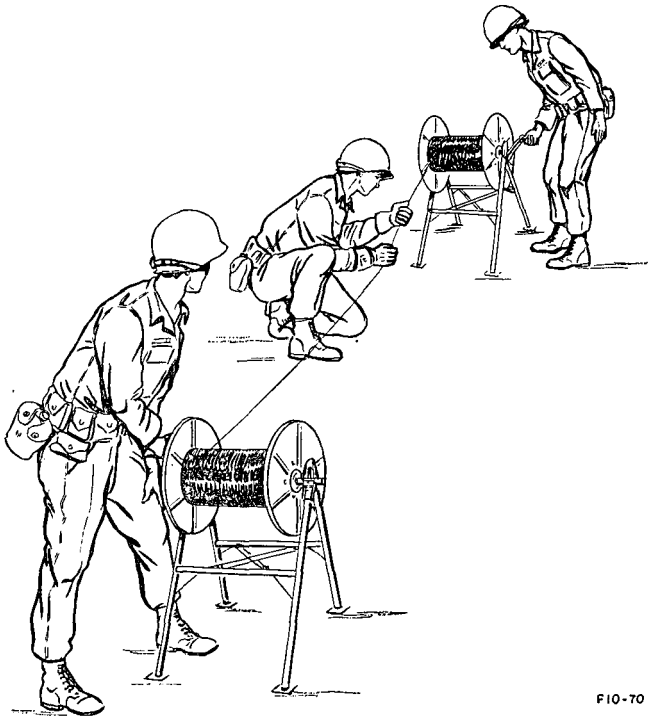

F10-70

Figure 73. Servicing field wire.

cated very close together, cut out the whole section and resplice the good sections of wire.

d. After each splice and at the finish of the reel, test the wire on the wound reel for open circuits, short circuits, or high loop resistance. A high resistance measure usually indicates poorly made splices. These tests are made with the test equipment described in chapter 8.

e. Wire Dispensers MX-306A/G are not refilled in lower-echelon units. However, the wire from the dispensers can be recovered and reconditioned with any of the steel reels.

72. Long-Span Construction

a. In the construction of long spans of Wire WD-1/TT, the length of the span, number of pairs, sag, and weather condition of the area must be considered (see TB SIG 243). Normally, the field wire is supported by a steel messenger cable (see TM 11-2262).

b. When a single wire is used for a long span without the support of a messenger cable, the method used for dead-ending the wire becomes much more

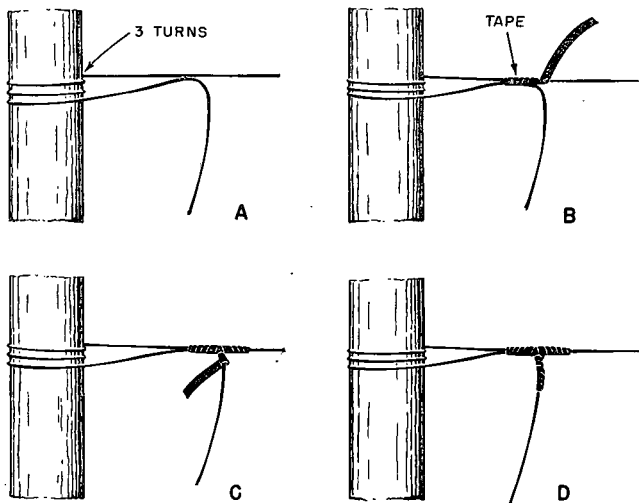

FIG-53

Figure 74. Dead-ending Wire WD-1/TT in long-span construction.

important. A correct dead end will prevent the wire from cutting the insulation at the tie point due to the weight of the wire in the span. Figure 74 shows the correct method of dead-ending a long span of Wire WD-1/TT around a pole. Note that the running end of the wire is given 3 turns around the pole and taped to the standing part of the wire.

Section IV. CONSTRUCTION UNDER UNUSUAL CONDITIONS

73. General

A knowledge of the field conditions under which a unit will operate is necessary for overcoming any unusual problems that might arise. Unusual conditions of terrain and climate will, for example, affect the speed of construction. It must be remembered that good construction practices must always be observed in any constructions regardless of the difficult condition. In general, wire lines should be tagged more often, there should be shorter distances between test stations, and the field-wire ties that are used should be suitable for the climatic conditions, terrain, and construction used.

74. Mountainous Areas

a. Establishing and maintaining wire communications in mountainous terrain is usually a difficult operation. Wire communication systems are more subject to damage by heavy icing of lines, rockfalls, and snowslides, all of which cause frequent interruptions in service.

b. Aerial reconnaissance often is the most effective means for establishing wire lines in mountainous areas. Trails, routes, and sheltered areas not

otherwise visible on the ground are easily visible from the air. Once the wire route has been determined, supply points must be established along the route. Air drop and man-pack are two methods used to establish these supply points. Wire lines in mountainous terrain must be tied at frequent intervals to prevent insulation damage due to winds rubbing the wire against sharp rocks. In winter, lance-pole constructions must be well-guyed and high enough to raise the lines above the level of the snow.

75. Arctic Areas

a. When possible, field wire should be stored in a heated shelter. This prevents the wire from becoming brittle, eliminates cracking of the insulation, and keeps the wire in a pliable working condition. Heated vehicles should be used when laying wire in extreme cold (temperatures 100° F. below 0° F. have been recorded in arctic regions). The Arctic Personnel Shelter Kit mounted on a 2½-ton truck serves as a good wire-laying vehicle. The wire can be kept warm as it is spliced or payed out through the rear door. The shelter also provides the wire team with a needed place to warm up during the operation. Over very rough terrain and deep snow, track-laying vehicles and cargo sleds are often the most practical vehicles for cross-country wire laying.

b. When there are no trees or poles along the wire route, lash three lance poles together at the top to form a tripod. This will make a firm support to keep the wire lines off the ground. Always use basket hitch or weave ties when placing the wire overhead. Special care in the handling of insulated wire must

be taken in subzero areas to protect the insulation. Do not make field ties in a wire line. Bending the wire damages the insulation which could cause a short circuit. Electrical Insulation Tape TL-600/U (polyethylene) must be used in low-temperature areas because it is the only tape that retains its adhesiveness.

76. Desert Areas

a. The constant, dry climate of desert areas makes it possible to establish wire communications over longer distances than that possible in other climates. Field-wire lines must be buried or lance-pole construction used if the wire lines are expected to remain in operation for a long period of time. Newly buried lines show up readily on air photographs; therefore, great care should be taken to camouflage or otherwise prevent these buried lines from disclosing command posts and other important tactical installations.

b. Wire lines, including those buried, should be staked and tagged at frequent intervals and indicated on a map. If winds cause the sand to shift, the sand will in a short time cover the wire line and cause the wire route to be hidden.

77. Tropical Areas

a. Heavy undergrowth and damp spongy ground greatly reduce the speed and mobility of field-wire teams. A good reconnaissance is required before starting wire-laying operations. Aerial reconnaissance is not usually effective since the heavy jungle vegetation often hides the trails and possible wire

routes. Ground reconnaissance, in general, is the most practical method.

b. Frequent rain and constant dampness reduce the effective communication range of field-wire circuits. This range can be increased by using two separate pairs of field wire as conductors for one circuit, and by the use of repeaters and amplifying telephones.

c. Considerable maintenance is required in keeping jungle lines in operating condition. This often requires that wire maintenance teams be stationed at close intervals along the lines. Field-wire lines should also be tagged at more frequent intervals than normal to simplify maintenance.

d. Permanent-type jungle aerial construction is used when longer wire-line life and greater speech transmission range is required than that obtainable from wire lines laid on the ground. This construction makes use of a single field-wire line for each conductor of the single wire circuit. These lines are supported by forestry-type insulators (Insulator IL-3/G). Jungle aerial construction requires a cleared path approximately 8 feet wide through the undergrowth and overhead foliage.

CHAPTER 7

MAINTENANCE OF FIELD-WIRE SYSTEMS

78. General

Maintenance of field-wire systems includes the prevention and correction of troubles. Prevention of troubles on wire lines and equipment begins with the careful planning and selection of wire routes and the installation of a system using the approved methods of construction. Troubles will occur, however, on every field-wire circuit. To diagnose and remove circuit troubles efficiently, maintenance personnel should know the various troubles common to field-wire lines, and the effects of these troubles on circuit quality and speech transmission.

79. Common Field-Wire Troubles

Trouble can occur either in the wire line or in the terminal equipment connected to the line. Troubles in wire circuits include open circuits, short circuits, grounded circuits, or crossed circuits, or combinations of these defects at one or more points in the circuit. These common troubles are shown in figure 75 and are defined as follows:

a. A short circuit, or *short*, occurs when the two conductors of a pair come in electrical contact with each other. Shorts are usually the result of bruised or stripped insulation.



A SHORT CIRCUIT-TWO WIRES OF A PAIR IN CONTACT WITH EACH OTHER.



B OPEN CIRCUIT-A BREAK IN ONE OR BOTH WIRES OF A PAIR.



C GROUNDED CIRCUIT - ONE OR BOTH WIRES OF A PAIR IN CONTACT WITH A GROUNDED OBJECT.

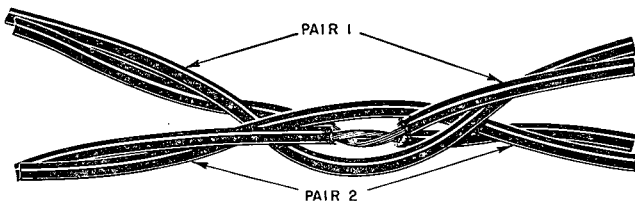

D CROSSED CIRCUIT-TWO WIRES, EACH OF A DIFFERENT PAIR, IN CONTACT WITH EACH OTHER.

F10-95

Figure 75. Common troubles in field-wire lines.

b. An open circuit, or *open*, is a break or cut in one or both conductors of a pair. Opens occur most frequently on long-span overhead construction, or at other points subject to strain.

c. A grounded circuit, or *ground*, occurs when one or both conductors of a circuit come in electrical contact with the ground or a grounded object. Grounds are the result of bruised insulation or poorly taped splices. Grounds will occur most frequently during rainy weather or when the line is installed in wet or damp areas.

d. A crossed circuit, or *cross*, exists when two conductors, each of a different pair, are in electrical contact with each other. Crossed circuits occur most frequently in field-wire cables supported on overhead spans, at points where multipair wire lines converge or are installed along the same route, and in locations subject to heavy traffic.

80. Trouble Symptoms

Field-wire troubles can exist in various degrees of severity. For example, partial opens and shorts can cause intermittent troubles that are often very difficult to locate. These troubles require the wireman to possess both knowledge and experience in the detecting, locating, and clearing of these defects. Knowledge in the use of test instruments and logical troubleshooting procedures are necessary to determine the nature and location of the trouble.

a. An open disrupts communication completely. However, a partial open or intermittent, due to a poorly made splice or loose contact, introduces a high resistance in the circuit. It might be possible to communicate over a partial open or highly re-

sistive circuit but the transmission is usually weak and noisy.

b. A complete (low resistance) short will disrupt communications completely. A partial (high resistance) short, however, usually causes weak transmission and signaling.

c. A ground on both sides of a circuit will produce the same effect as a short. Usually, a ground occurring on one side of a circuit will not interrupt communication but will introduce hum or noise in the circuit.

d. A cross usually causes cross talk or interference between the two crossed circuits which could be sufficient to make the separate conversations unintelligible.

81. Testing Methods

a. Test During Construction. Field wire, both new and used, should be tested before installation to determine its condition and serviceability. While constructing a line, tests are made after every underground installation, after every overhead span, at the end of each reel length, and before connecting the line to the terminal equipment. Testing the wire lines during construction will disclose troubles that might have developed during the wire-laying operation.

b. Routine Testing. Proper maintenance requires routine tests to be conducted at regular intervals on all working circuits and equipment. The frequency of these routine tests will vary according to the nature and importance of the circuits, the equipment, type of installation, the amount of traffic handled,

and amount of trouble experienced. Communication is never interrupted to make a routine test. A busy circuit indicates that it is trouble free. Routine tests should be made by the maintenance personnel during the slack traffic periods. The tests must include all the operating functions normally required of the circuit and equipment.

c. Troubleshooting. Tests are conducted when trouble is reported or detected on a circuit. The wireman must quickly analyze the fault, determine its location, and clear the trouble with the least possible interruption of service. High-priority circuits are rerouted or spare lines, along the same route, are put into service by patching at construction centers or test points.

d. Testing Wire Lines. Tests are usually made from the construction center, test station, or switching central. The test equipment used with field-wire installations is described in chapter 8. If no test equipment is available, a field telephone can be used to determine several troubles in field-wire circuits and equipment. The following tests can be made with a field telephone:

- (1) *Test for open.* Connect the ends of the circuit to be tested to the line terminals of the test telephone. Turn the generator crank of the telephone rapidly. If the crank turns freely without a drag, the circuit is open.
- (2) *Test for short.* Connect the ends of the circuit to the line terminals of the test telephone. Turn the generator crank of the telephone rapidly. If the crank turns hard

with a heavy drag, the circuit is short-circuited or grounded on both sides.

- (3) *Test for ground.* Connect one conductor of the circuit to one line terminal of the test telephone. Connect the other line terminal of the telephone to a ground stake. If there is a ground on that side of the circuit, the generator will turn hard as in the case of the short. Test the other side of the circuit in the same manner.
- (4) *Test for cross.* Connect *both* conductors of the first circuit to one line terminal of the telephone and *both* conductors of the second circuit to the other line terminal of the telephone. Turn the generator crank. The generator should turn as freely as on an open circuit. If it does not, the circuits are crossed.

82. Locating and Clearing Troubles

a. Localizing Trouble. After the trouble is verified, the first step in clearing trouble is to localize the defect to an equipment or particular section of a circuit. Further tests are made within the section until the trouble source is located. Before testing a line, always check the circuit to determine whether or not it is in use. Never open a circuit that is in operation.

b. Wire-line Troubles.

- (1) *General.* If tests indicate that the trouble is in the wire line, the wireman should determine accurately the nature and approximate location of the fault. Often, in-

formation such as the type of terrain over which the wire is laid, unusual troop activities, or shellfire in an area, will aid the repairman in locating the trouble.

- (2) *Preliminary checks.* Normally, a wire team crew is sent out along the line route with the required maintenance equipment. The wire line should be carefully examined with particular attention to: the condition of the insulation, splices; underground and overhead crossings; ties on swaying trees; the places where the wire has been run over or pulled out of place by vehicular traffic. Bruised insulation, poorly made splices, and other possible trouble spots are repaired and tested along the route. If no obvious troubles are found, tests are made at frequent intervals along the line back to the terminal testing point.
- (3) *Tests.* When checking for an open circuit, connect the test equipment across the circuit without cutting the wire line. When checking for a ground or short, it will be necessary to cut the line. When possible, always open a circuit at a splice or at a test point nearest a terminal end. Tape all points where the insulation of the line was pierced or removed during a test. If each test proves that the line is serviceable toward the terminal testing point, the trouble exists farther out along the line. If the repairman cannot communicate with the terminal test point, he has passed the trouble

and, therefore, should work back along the line, dividing in half the distance between successive tests. A defective circuit could have trouble at more than one point. It is, therefore, essential that the repairman make a complete circuit test after removing each trouble.

- (4) *Visual inspection.* Testing at too frequent intervals at the start of the troubleshooting procedure can delay the locating of the line trouble. Considerable time is consumed in splicing a circuit after making tests for shorts and grounds. This delays repair of the circuit. A visual inspection of the wire lines often will disclose the trouble sooner. However, if any long section of the line cannot be inspected visually, make tests at each end of that particular section.

c. Equipment Trouble. If trouble is found on terminal equipment, the prescribed tests are given in the technical manuals on the specific equipment. Equipment repairs will be performed only by qualified personnel at the proper repair echelon.

d. Patrolling Wire Lines. In certain critical areas, the routine maintenance testing of a wire line is commonly supplemented by patrolling the section of the line most subject to damage. When possible, the wiremen who have constructed a given section should also be assigned the mission of patrolling that section. Wire patrols repair trouble where needed, replace poor slices or sections of the line, tape any insulation abrasions, and generally improve the line construction.

83. Records

It is essential that various installation and maintenance records be kept to insure uninterrupted communications. These records include line route maps, circuit diagrams, and traffic diagrams. These records must show all changes in a wire line throughout its operation. In addition, trouble reports, test records, and work schedule rosters are maintained when necessary.

84. Use of Test Stations

a. Purpose. Establishing test stations at important line route junctions and at points where trouble is anticipated, simplifies the troubleshooting and repair of field-wire lines. In field-wire installations, these test stations usually consist of one or more terminal strips (Terminal Strip TM-184 or Terminal Box TA-125/GT) installed in an accessible location and protected, if possible, from the weather.

b. Test Personnel. Test stations may or may not be manned. A manned test station can coordinate with the repairman on the line for rapid troubleshooting. Prearranged signals or instructions to the test personnel to monitor a particular circuit should be previously arranged by the wireman. If needed, a simplex or phantom circuit (pars. 112-114) can be set up temporarily to assist in this operation.

c. Cross-Patching Circuits. The cross-patching of circuits at test stations or switching centrals frequently allows communications to be maintained during the troubleshooting period. For example, assume that two telephone centrals are connected by two circuits passed through a common test station;

one circuit has trouble on the near side of the test station, and the other circuit has trouble on the far side. To salvage or reestablish one serviceable circuit, take the good section at each side of the test station and connect (cross patch) the sections together. Restore the original connections once the repairs have been made.

CHAPTER 8

CHARACTERISTICS OF COMMUNICATION EQUIPMENT

Section I. INTRODUCTION

85. General

This chapter is a review of the communication equipment most likely to be used in field-wire systems. The information is limited to a brief description of individual items of equipment. For more detailed information on any specific equipment, refer to the technical manual or other publication on that item.

86. Power Supply

a. General. Most of the portable communication equipments described in this chapter require a power source. In some instances this power source might be a battery or battery pack—in others, a gasoline engine-generator, or centralized power source is used.

b. Battery. When the communication equipment requires battery power, be sure to check the equipment manual for the proper battery nomenclature. When the specific battery or batteries are not available, consider the following factors before selecting a substitute:

- (1) Voltages required.
- (2) Minimum power requirements (battery life is affected by the equipment current drain).

- (3) Physical size of battery in relation to the space available in the equipment battery compartment.
- (4) Type of battery connections on the equipment.

c. Other Power Sources. Equipments requiring a steady power supply over a long period of time usually use a centralized power source, or the power provided by a gasoline engine-generator. The equipment load must not exceed the capabilities of the power source. Before attempting to connect any equipment, check the power and voltage output of the power sources against the power and voltage requirements specified for the equipment.

Section II. FIELD TELEPHONES

87. General Description of Field Telephones

a. Field telephone sets are portable, self-contained telephone sets designed for use in the field. These sets combine durable construction with portability. The selection of a specific field telephone depends on the type of service available. The telephone service might be over switched circuits, over point-to-point circuits, or within security-restricted nets. The length of the circuit, and the type of switchboard or circuit used will also determine the field telephone to be used.

b. There are two principal types of field telephones, sound-powered and battery-powered. Sound-powered telephones have a shorter voice range than battery-powered telephones. Sound-powered telephones can be used with or in place of local-battery telephones. However, sound-powered

telephones cannot be used in common-battery systems. In a sound-powered telephone, the transmitter unit is the generator of the electrical energy. The sound waves created by the voice of the speaker strike the transmitter unit and are converted directly into electrical energy. The receiver unit of the distant telephone reconverts this electrical energy back again to the original sound waves. In a battery-powered telephone, small dry batteries contained inside the telephone are used as a source of transmission power. When a battery-powered telephone is used in a common-battery system, these batteries inside the telephone may not (depending on the equipment) be necessary. Field telephones contain hand-operated magnetos or ringing generators, for signaling. The incoming ringing signals are indicated audibly by a bell or buzzer, or visually by a light or noiseless signal device.

c. The talking ranges of the principal field telephones are summarized in the table below:

Field telephones	Talking distances using wire WD-1/TT (NONLOADED)*	
	Wet conditions (mi)	Dry conditions (mi)
TA-43/PT (TA-312/PT)-----	14	22
EE-8-()-----	12	18
TA-1()/TT-----	4	7½
TP-3-----	4	7½
TP-9 (TA-264/PT):		
with amplifiers-----	38	60
without amplifiers-----	12	18

*The above distances are approximate. Factors that affect the talking ranges are: number and quality of splices, weather conditions, number of switching centrals and test stations, noise, cross talk and other interference in a circuit.

88. Telephone Set TA-43/PT

a. Telephone Set TA-43/PT (fig. 76) is a light-weight, weatherproof, battery-powered field telephone set designed for use in either local-battery or common-battery telephone systems.

b. Telephone Set TA-43/PT can be used as station equipment in all manual telephone switching systems. The screw switch (marked CB, LB, CB-LB) adapts the telephone for either common-battery (CB) operation, local-battery (LB) operation, or common-battery signaling—local-battery opera-



FIG 76

Figure 76. Telephone Set TA-43/PT.

tion. Batteries are not required for voice transmission when the telephone is used in a common-battery system.

c. For more detailed information, refer to TM 11-337.

89. Telephone EE-8-()

a. Telephone EE-8-() (fig. 77) is a portable, battery-powered field telephone set designed for use

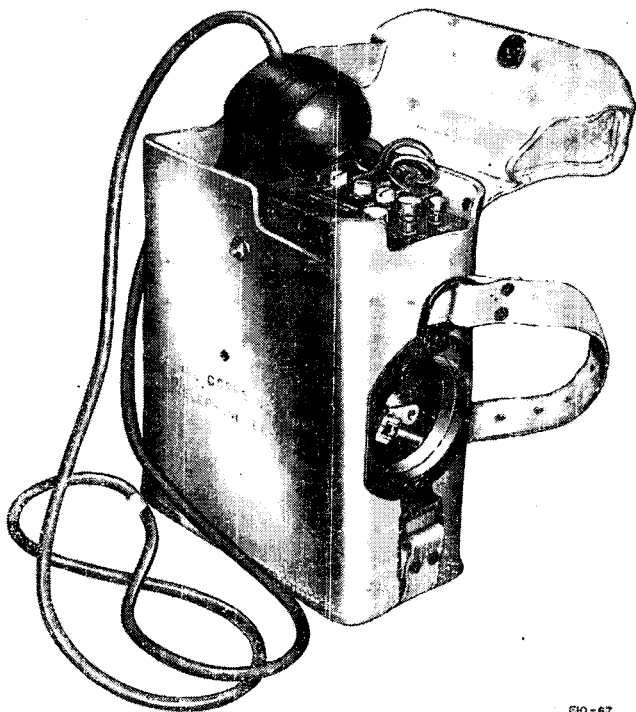

FIG-67

Figure 77. Telephone EE-8-().

in either local-battery or common-battery systems. The telephone will operate satisfactorily over well-constructed wire lines for distances normally required in tactical field-wire nets. Batteries are required for both LB and CB operation. A screw switch adapts the telephone for either type of operation. The hand generator must not be used for signaling purposes when the telephone is used on CB operation. This prevents excessive line current which could damage the switchboard equipment.

b. Telephone EE-8-() will eventually be replaced by Telephone Set TA-43/PT. For further information, refer to TM 11-333.

90. Telephone TA-1()/TT

a. Telephone TA-1 ()/TT (fig. 78) is a complete, sound-powered field telephone set in handset form. It provides facilities for talking and signaling without the use of batteries. The approximate talking and signaling range of the TA-1()/TT is 4 miles over Wire WD-1/TT. The telephone set can be used to advantage in advanced forward areas, in switched networks having magneto signaling switchboards, closed nets, and point-to-point circuits.

b. The telephone handset contains sound-powered transmitter and receiver units, a hand generator which is operated by a lever-type switch, and a push-to-talk switch. The user can choose to receive either visual or audible-visual signaling indications during operation.

c. To install the telephone, connect the field-wire conductors to the binding posts on the terminal block at the end of the cord. To signal the distant telephone, depress the generator lever. To silence the

audible signal, turn the switch on the back of the telephone to the OFF position. The volume of the audible signal can be controlled by turning the switch to various settings between the OFF and LOUD positions. To talk to the distant station, press the push-to-talk switch. It is possible to hear the distant party faintly if he tries to interrupt while the push-to-talk switch is depressed, but it is necessary to release the switch to hear him clearly.

d. For further information, refer to instruction manual for Telephone TA-1()/TT.

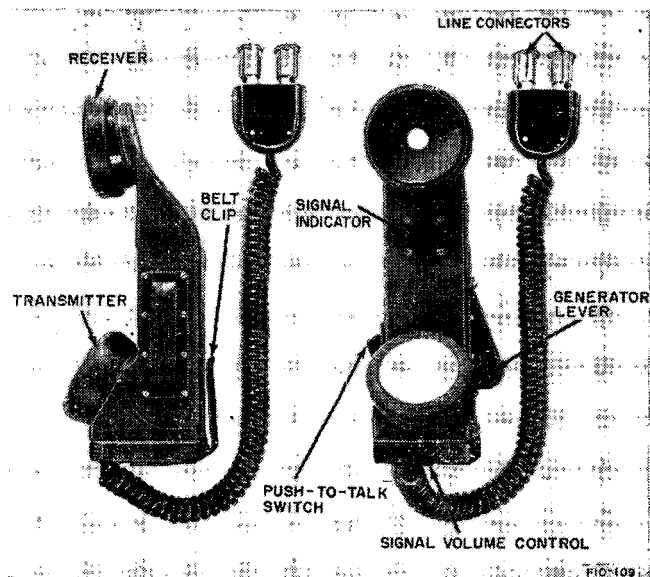

Figure 78. Telephone TA-1()/TT.

91. Telephone TP-3

a. Telephone TP-3 (fig. 79) is a portable, sound-powered field telephone set for use on point-to-point circuits, or in small nets in local-battery systems.

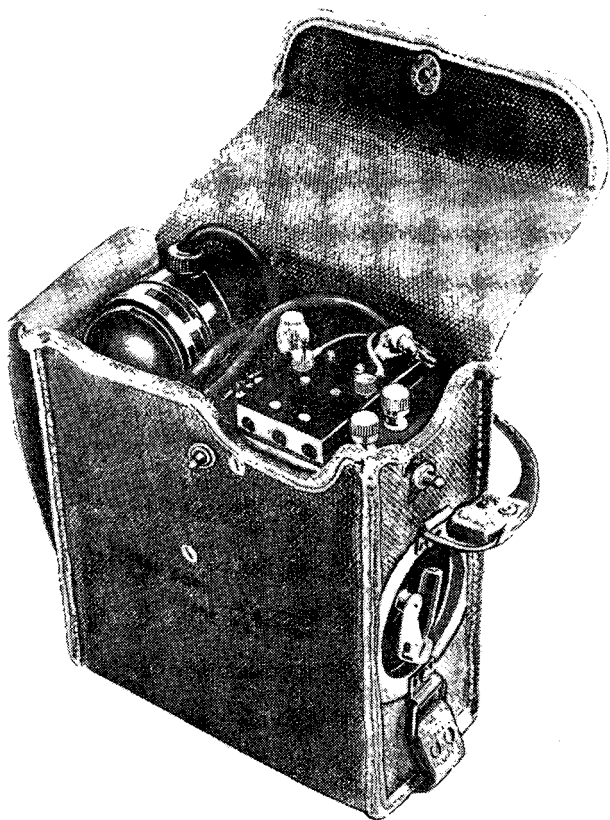

FIG-69

Figure 79. Telephone TP-3.

No batteries are required for its operation. A hand generator provides the ringing signals. The incoming ringing signal can be indicated either audibly or visually.

b. For additional information, refer to TM 11-2043.

92. Telephone TP-9 and TA-264/PT

a. Telephone TP-9 (fig. 80) is a portable battery-powered field telephone set designed for use on long field-wire lines. Vacuum-tube amplifiers in both the transmitting and receiving circuits of the telephone make communication possible over greater distances than that obtainable with other field telephone sets. Forward observers in combat areas, for example, would find excellent use for this telephone. When the amplifiers are in use, communication is on a one-way reversible basis. The telephone can also be used without amplifiers for full-duplex operation (both parties can talk and listen at the same time).

b. Telephone TP-9 cannot be used in common-battery systems. The incoming ringing signal can be indicated audibly or visually.

c. Telephone Set TA-264()/PT will eventually replace Telephone TP-9. These telephone sets are operationally interchangeable. For further information, refer to TM 11-2059.

Section III. MANUAL TELEPHONE SWITCHBOARDS

93. General

Manual telephone switchboards are designed for use in several types of operation, such as common battery (CB) ; local battery (LB) ; and common bat-

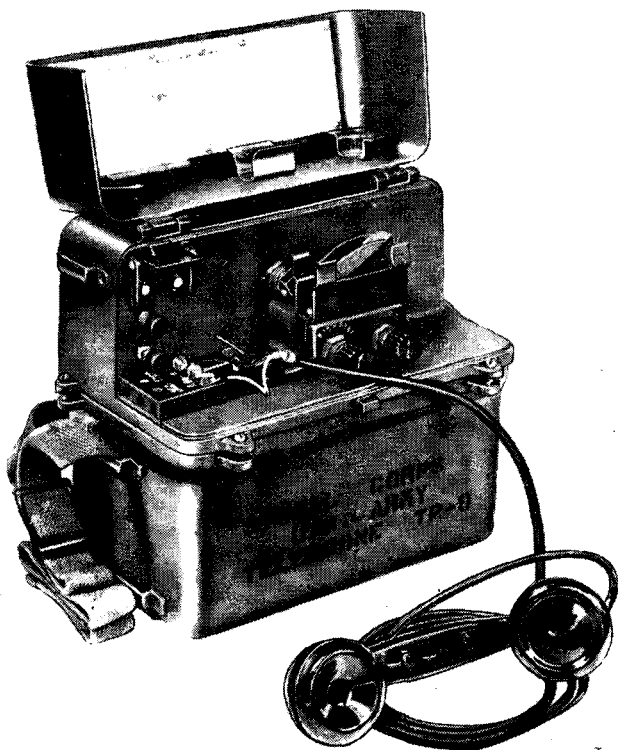

FIO-68

Figure 80. Telephone TP-9.

tery signaling—local battery operation. Some field switchboards are designed specifically for one type of operation. Others are designed for all three types of operation. Field telephone switchboards are manually operated switchboards constructed to withstand rough handling and designed for quick simple installation. In a common-battery system,

the source of electrical energy for speech and ringing signals is located at the switchboard telephone central. In a local-battery system, this source of electrical energy is a component part of the telephone set. In the other system (CB signaling—LB operation), the source of power for speech is part of the telephone set; the power for signaling the switchboard is located at the switchboard.

94. Emergency Switchboard SB-18/GT

a. Emergency Switchboard SB-18/GT (fig. 81) is a light, portable local-battery switching center

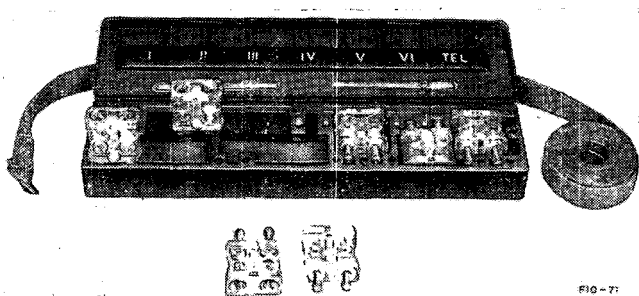

Figure 81. Emergency Switchboard SB-18/GT.

normally used in company-size units. It consists of a plug holder and seven two-pronged Adapter Plugs U-4/GT in a case. A field telephone is required for the operator's use. The SB-18/GT may be used as an emergency field replacement for any local-battery switchboard.

b. Each Adapter Plug U-4/GT (fig. 82) consists of a neon glow lamp, two binding posts, two prongs, and two sockets, all molded together in a translucent plastic housing. The prongs serve as the thumb

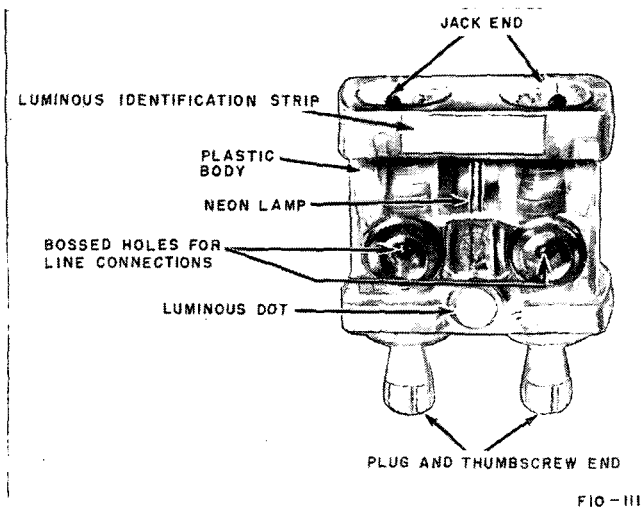

Figure 82. Adapter Plug U-4/GT.

screw ends of binding posts to which incoming lines are connected. The prongs also are inserted into the sockets of another plug to establish a connection between two lines.

c. Several adapter plugs can be connected in tandem for conference connections (several separate parties conversing at the same time). An incoming ringing signal lights the neon lamp in the switchboard plug connected to the line. An audible signal is not heard when the neon lamp lights, unless the switchboard operator's telephone is connected to that line.

d. A luminous dot on either side of each adapter plug simplifies switchboard operation during the darkness. The number of the line to which each

plug is connected can be written in pencil or ink on the luminous identification strip embedded in the surface of the plug.

e. Emergency Switchboard SB-18/GT is described in detail in TB 11-333-1.

95. Manual Telephone Switchboard SB-22/PT

a. Manual Telephone Switchboard SB-22/PT (fig. 83) is a single-position field telephone switchboard used primarily in field-wire systems. It is small, lightweight, portable, immersionproof, and requires no special mounting equipment for operation.

b. The switchboard is equipped for interconnecting local-battery telephone lines, voice-frequency teletypewriter circuits, and remote-control circuits for radio communication. Each switchboard has a maximum capacity for switching either 12 field tele-

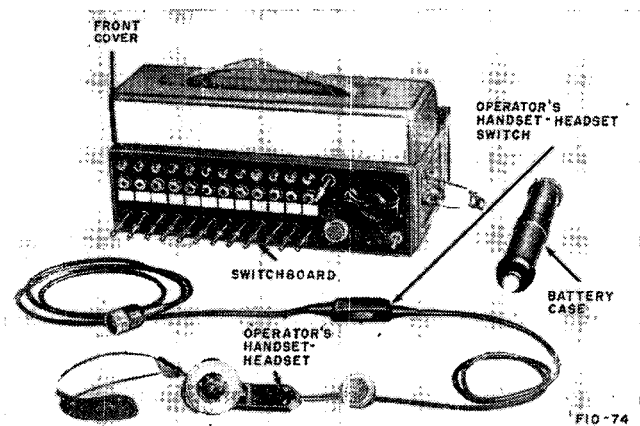

Figure 83. Manual Telephone Switchboard SB-22/PT.

phones, 12 voice-frequency teletypewriter circuits, or 12 remote-control circuits or a combination of these facilities. A capacity of 29 circuits can be obtained by stacking two switchboards and replacing the ringing generator of one switchboard with five additional line packs. The SB-22/PT obtains operating power from four Batteries BA-30.

c. For detailed information, refer to TM 11-2202.

96. Manual Telephone Switchboard SB-86/P

a. Manual Telephone Switchboard SB-86/P (fig. 84) is a portable, single-position field telephone switchboard used primarily in field-wire systems. The switchboard is formed of component parts which can be rapidly assembled or dismantled during a tactical deployment. It is used to interconnect voice-frequency teletypewriter circuits.

b. Manual Telephone Switchboard SB-86/P consists of a portable jack field section, Switchboard Signal Assembly TA-207/P, and Manual Telephone Switchboard Section SB-248/P. The jack field section has a capacity of 30 complete line circuits. In addition to the jacks, the jack field section contains the line signals, designation strips, panel lamps, and switches necessary for operation of the switchboard. A second jack field can be stacked on top of the first to increase the capacity of the switchboard to 60 line circuits. The switchboard section consists of 8 replaceable groups: 16 answering and 16 calling cords.

c. Local-battery or common-battery signaling can be selected by using a switch associated with each line circuit. There are also two common-battery line circuits for use with common-battery switchboards.

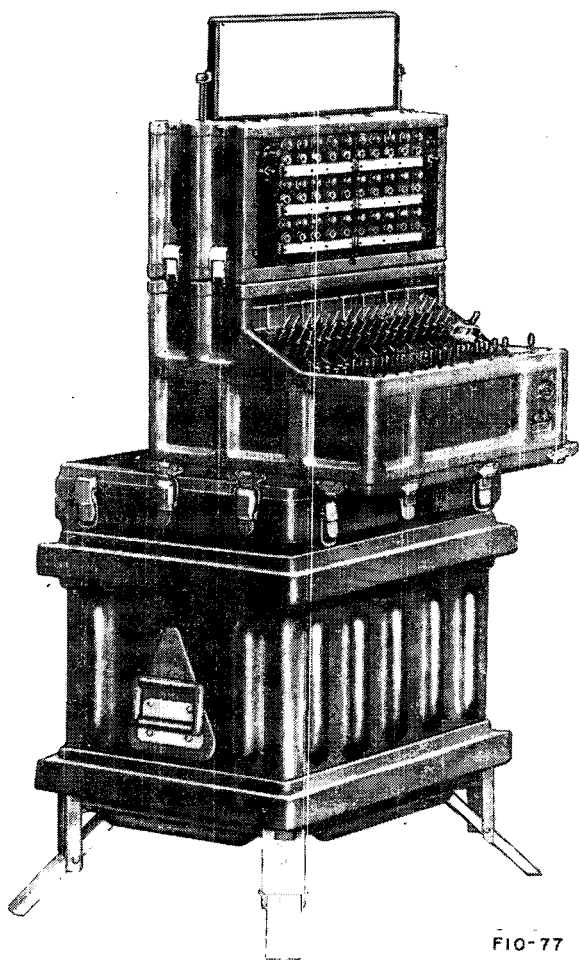

FIG-77

Figure 84. Manual Telephone Switchboard SB-86/P.

- d.* The cord circuits of the switchboard do not supply battery power to the distant telephone for speech transmission; therefore, only local-battery telephones or telephones designed for common-battery signaling can be used with this switchboard.
- e.* For further information, refer to TM 11-2134.

Section IV. FIELD TELETYPEWRITERS

97. General

a. A teletypewriter is an electromechanical machine for the transmission and reception of coded electrical impulses that are converted into a recorded message. Messages are recorded by either of two methods—typed page copy (page-printing teletypewriters) and code perforations on tape (reperforator teletypewriters). Some teletypewriters that record messages by code perforations on tape also record the typewritten characters on the same tape (typing reperforator teletypewriters). Teletypewriter messages are transmitted manually by typing the message on a keyboard or by transmitting automatically from perforated tape in a transmitter-distributor.

b. A teletypewriter uses both alternating-current (ac) and direct-current (dc) power for its operation. Dc power can be used for all purposes, although a combination of ac and dc power is commonly used. Dc power must be used for the line current. When a centralized power source is not available, a small engine-generator unit is used for furnishing power for the teletypewriter. Batteries are not used because of the heavy power requirements of the equipment.

c. Tactical teletypewriter sets are provided with carrying cases, power supplies, necessary accessories, such as paper, perforating tape, printing ribbons, and a supply of spare parts.

98. Teletypewriter Set AN/PGC-1

a. Teletypewriter Set AN/PGC-1 (fig. 85) is a lightweight, portable, page-printing, sending and

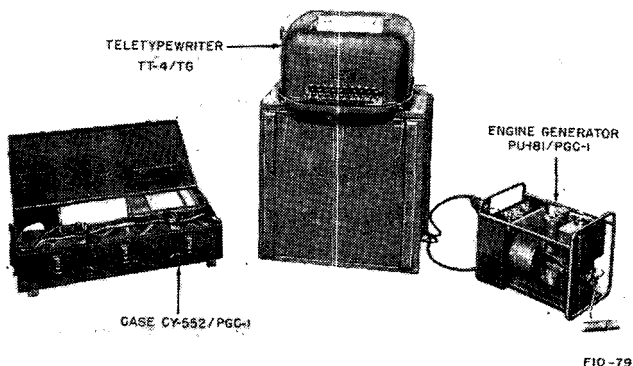

Figure 85. Teletypewriter Set AN/PGC-1.

receiving teletypewriter set designed for field use. The set consists of a standard communication teletypewriter (Teletypewriter TT-4()/TG) and an accessories case.

b. Teletypewriter TT-4()/TG is capable of sending and receiving standard teletypewriter start-stop, five-unit code impulses at the speed of 60, 66, or 100 words per minute, depending on the motor-drive gear set used. It is designed for neutral operation over dc telegraph lines, wire line carrier systems, or radio carrier systems. Operation in 60

milliamperes dc or 20 milliamperes dc is made possible by using a change-over switch.

c. Teletypewriter TT-4()/TG requires a 105- to 125-volt dc, or a 105- to 125-volt, 50- to 60-cps, single-phase, ac power source. Engine Generator PU-181/PGC-1 normally is used to supply the necessary power requirements.

d. For more detailed information, refer to TM 11-2235.

99. Teletypewriter Set AN/GGC-3

a. Teletypewriter Set AN/GGC-3 (fig. 86) is a lightweight, portable sending and receiving teletypewriter set. It is used in either tactical or fixed-station military systems. The transmitted message is sent from either a keyboard or a tape transmitter. The received signals are recorded both in code perforations and in typewritten characters on the same tape. Teletypewriter Reperforator-Transmitter TT-76/GGC, the major component of the set, is equipped with a standard communication keyboard and type wheel.

b. Teletypewriter Reperforator-Transmitter TT-76/GGC can be arranged to operate with either neutral or polar signals on a half- or a full-duplex basis. The selector magnet of this unit can be adapted for 20-milliampere or 60-milliampere dc line current. The unit is capable of sending and receiving standard teletypewriter five-unit, start-stop, code impulses at a speed of 60 or 100 words per minute depending on the motor-drive gear that is used in the particular set.

c. Teletypewriter Set AN/GGC-3 is not equipped to supply the dc power for the signal line circuits.

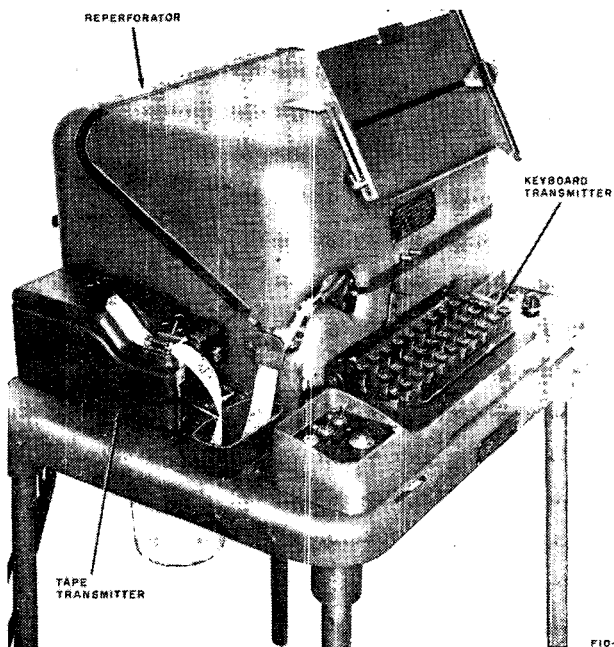

FIG-83.

Figure 86. Teletypewriter Set AN/GGC-3.

This must be supplied by a telegraph switchboard, a line unit, or another external source. A 115- or 230-volt ac power supply which can provide 150 watts of power is required for the operation of the teletypewriter motor and rectifier. If a line unit or another line-terminating device is used, the power requirements must be increased.

d. Although Teletypewriter Set AN/GGC-3 is designed for fixed-station and field purposes, do not expose it to rain, snow, excessive heat, or dampness. When possible, install the set under shelter.

e. For detailed information, refer to TM 11-2225.

Section V. TELEPHONE REPEATERS

100. General

a. A telephone repeater is an amplifier or a device used to increase the strength of a signal that has been decreased by line losses. Repeaters consist essentially of vacuum-tube amplifiers and such associated components as repeating coils, equalizer networks, and hybrid coils. Amplifiers increase the signal in one direction only. Since a telephone system must provide for two-way communication, most repeaters use separate amplifier circuits for transmitting and receiving.

b. Repeaters used at the ends of a transmission line are called *terminal repeaters*; those used between the ends of a transmission line are called *intermediate repeaters*.

c. The proper spacing of repeaters depends on the characteristics of the transmission line and the amplification capabilities of the repeater.

101. Telephone Repeater TA-126/GT

a. Telephone Repeater TA-126/GT (fig. 87) is a portable, single-channel terminal repeater. It provides stable, good-quality, telephone circuits over field-wire systems under all weather conditions.

b. Although Telephone Repeater TA-126/GT is used primarily over Wire WD-1/TT, it also can be used over other wire lines having the same electrical characteristics. The telephone repeater uses either 20-cps or voice-frequency signaling and can be used with field telephones, field telephone switchboards, speech plus telegraph, multichannel telegraph termi-

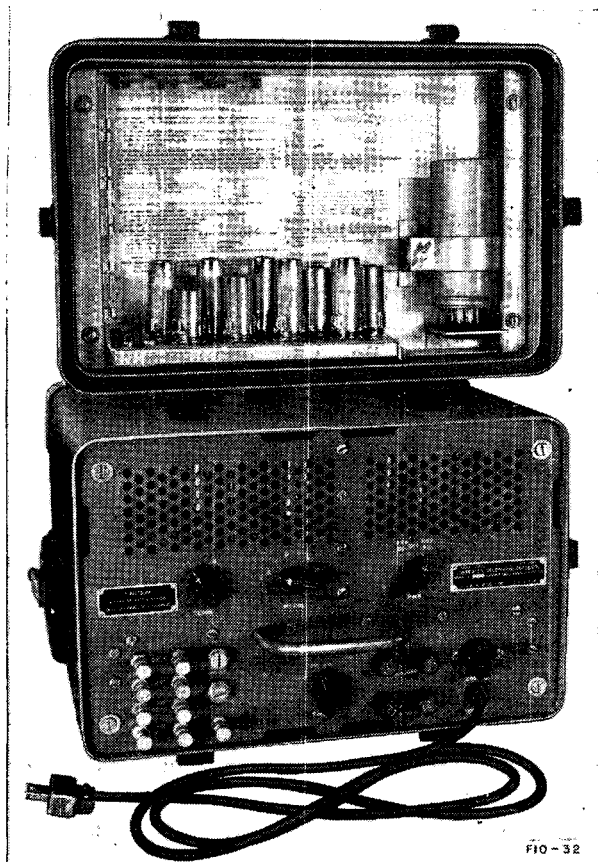

Figure 87. Telephone Repeater TA-126/GT.

nals, and data transmission equipment. The power requirements are 115 volts ac or 24 volts dc.

c. The circuit arrangements shown in figure 88 illustrate the use of one or more repeaters for obtaining satisfactory transmission standards on point-

to-point circuits (A, fig. 88) or on long-local and trunk circuits (B, fig. 88).

d. For detailed information, refer to TM 11-2135.

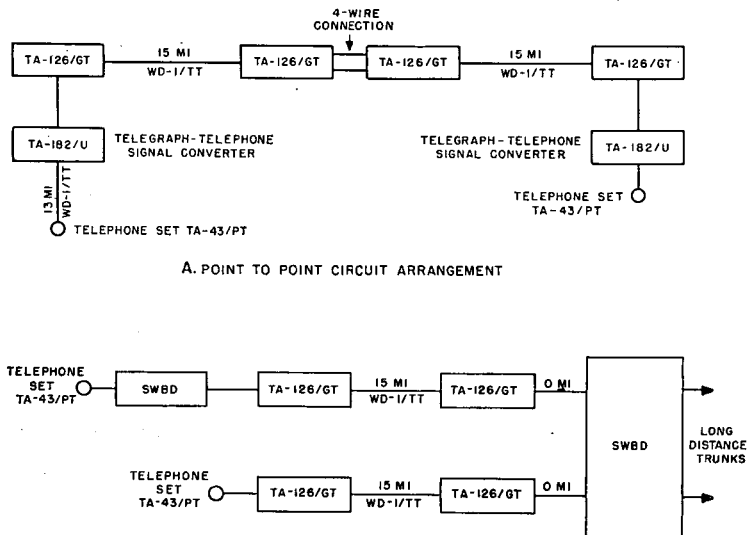

FIG-90

Figure 88. Circuit arrangements, using Telephone Repeater TA-126/GT.

102. Telephone Repeater EE-89-()

a. Telephone Repeater EE-89-() (fig. 89) is a portable, voice-frequency intermediate repeater designed for use on field-wire systems. Simplex telegraph operation and 20-cps ringing are possible over lines equipped with one or more of these repeaters.

b. Telephone Repeater EE-89-() is used only with lines having the same electrical characteristics on either side of the repeater. Best results are ob-

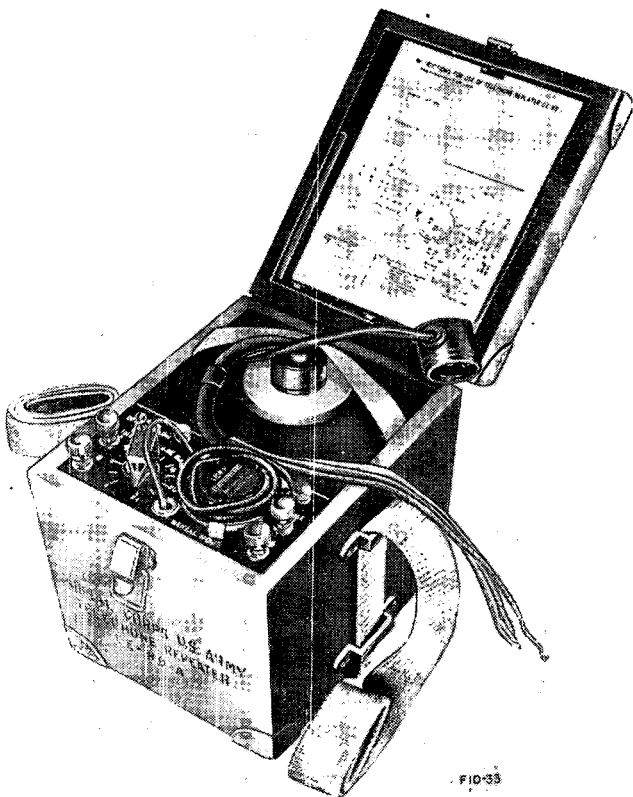

Figure 89. Telephone Repeater EE-89-A.

tained when the repeater is placed in the exact center of the line.

c. Battery BA-40 normally is installed in the repeater battery compartment. However, connection for external batteries is possible.

d. For detailed information, refer to TM 11-2006.

103. Telephone Repeater TP-14

a. Telephone Repeater TP-14 (fig. 90) is a portable unit used to extend the telephone communication range over a wide variety of two-wire line facilities. It may be used at terminal and intermediate points, at junctions of different types of line facilities, and at points where entrance cables are used.

b. If desired, Telephone Repeater TP-14 can be used for interconnecting two-wire and four-wire facilities, or as a special form of four-wire repeater. The repeater has simplex terminal connections for dc telegraph operation. Twenty-cps ringing signals can pass through the repeater.

c. The repeater uses an ac power supply, storage batteries, or dry batteries as a power source.

d. For detailed information, refer to TM 11-2007.

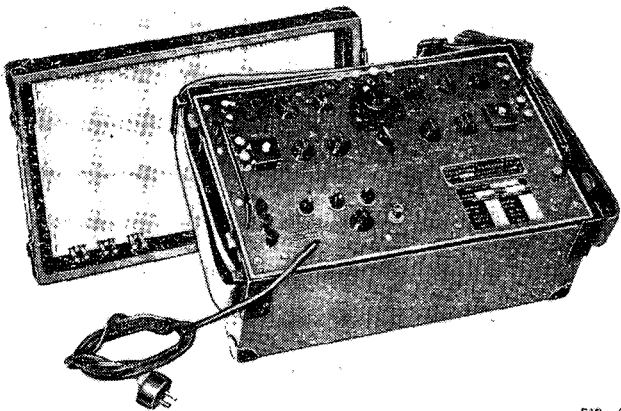

FIG - 20

Figure 90. Telephone Repeater TP-14.

Section VI. TELEGRAPH-TELEPHONE TERMINAL AN/TCC-14

104. General

a. Telegraph-Telephone Terminal AN/TCC-14 (fig. 91) is transportable, carrier-type terminal equipment that provides simultaneous telephone and teletypewriter service over a normal telephone circuit. It consists of three separate components—Telegraph Terminal TH-5/TG, Electrical Filter Assembly F-98/U, and Telegraph-Telephone Signal Converter TA-182/U. Telegraph-Telephone Terminal AN/TCC-14 can be used in point-to-point networks, switched telephone systems, and in remote-control radio systems.

b. For detailed information, refer to TM 11-2239.

105. Telegraph Terminal TH-5/TG

a. Telegraph Terminal TH-5/TG is a lightweight, portable frequency-shift carrier modulator and demodulator. It is used to modulate (or convert) dc teletypewriter pulses to 1,225-cps and 1,325-cps signals and to demodulate these signals back again to dc teletypewriter pulses. The ac signal is a voice-frequency (vf) signal because it lies within the voice-frequency range.

b. The vf telegraph system can be used over existing facilities of a telephone system. This is an advantage over the dc telegraph system since the vf telegraph circuits can be switched through telephone switchboards. Dc telegraph circuits require a separate dc teletypewriter switchboard.

c. Telegraph Terminal TH-5/TG is designed for one-way reversible operation and is used with Tele-

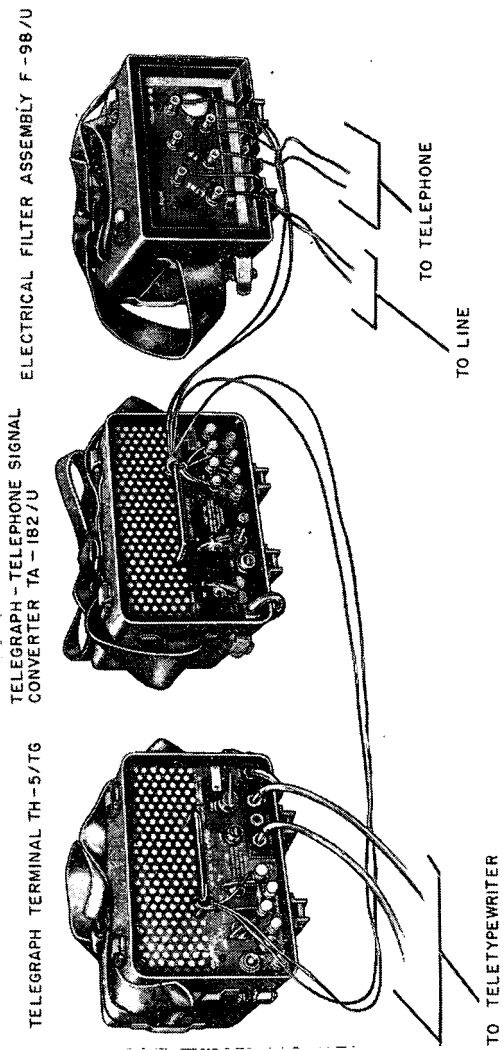

FIG - 107

Figure 91. Telegraph-Telephone Terminal AN/TCC-14.

graph-Telephone Signal Converter TA-182/U and Electrical Filter Assembly F-98/U. It operates only with 20-milliampere teletypewriter line current pulses. This terminal can be used in two-wire, four-wire, and radioteletype applications. The telegraph terminal requires a 115-volt, 50- to 60-cycle ac power supply for operation.

106. Telegraph-Telephone Signal Converter TA-182/U

a. Telegraph-Telephone Signal Converter TA-182/U is a portable frequency-shift carrier modulator and demodulator commonly called a voice-frequency ringer. This converter makes it possible to pass 20-cps ringing signals over circuits that would not ordinarily pass this frequency. The ringing signal from a field telephone or switchboard is converted into a higher frequency within the voice-frequency range.

b. The TA-182/U requires a 115-volt, 50- to 60-cycle ac power source for operation.

c. The signal converter is used in certain circuit applications with Telegraph Terminal TH-5/TG and Electrical Filter Assembly F-98/U. For additional information, refer to TM 11-2137.

107. Electrical Filter Assembly F-98/U

a. Electrical Filter Assembly F-98/U is a portable, two-section filter. The filter permits simultaneous teletypewriter and telephone service over existing telephone facilities. The band-pass section is used for teletypewriter transmission; the band-stop section is used for telephone transmission.

b. The electrical filter assembly is used with Tele-

graph Terminal TH-5/TG and Telegraph-Telephone Signal Converter TA-182/U. For additional information, refer to TM 11-2239.

108. System Application

Telegraph-Telephone Terminal AN/TCC-14 has many applications. Some of the applications given below do not require using all the components of the equipment.

a. Telegraph-Only Service. This application is designed solely for teletypewriter communication. Speech transmission is not involved.

b. Alternate Telegraph-Telephone Service (figs. 92 and 93). This application is designed for either telegraph or telephone use. Telegraph and telephone service, however, cannot be used at the same time.

c. Simultaneous Telegraph-Telephone Service. This application is designed to provide a two-wire, voice-frequency channel that can pass teletypewriter and telephone signals simultaneously (fig. 94). However, teletypewriter and telephone circuits cannot be switched (or signaled) separately. Electrical Filter Assembly F-98/U is used to separate teletypewriter and telephone transmission at the terminal.

d. Speech.Plus Half-Duplex Service. This application is designed to provide a two-wire, voice-frequency channel which can pass teletypewriter and telephone signals simultaneously. Both teletypewriter and telephone circuits on the same wire line are completely independent of each other and are switched (or signaled) separately. Electrical Filter Assembly F-98/U is used to separate teletypewriter

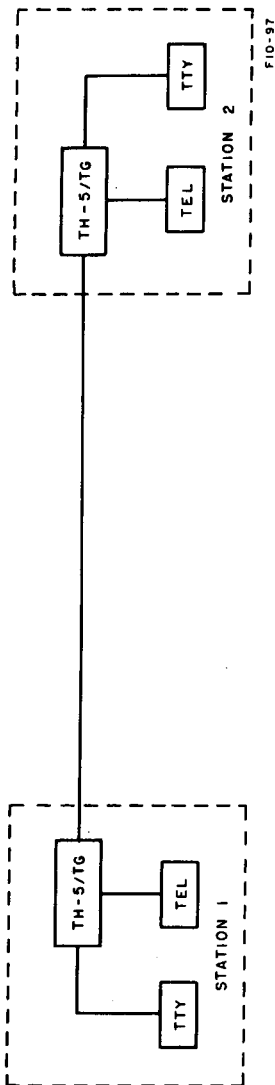

Figure 92. Alternate telegraph-telephone service on point-to-point circuit, using Telegraph Terminal TH-5/TG.

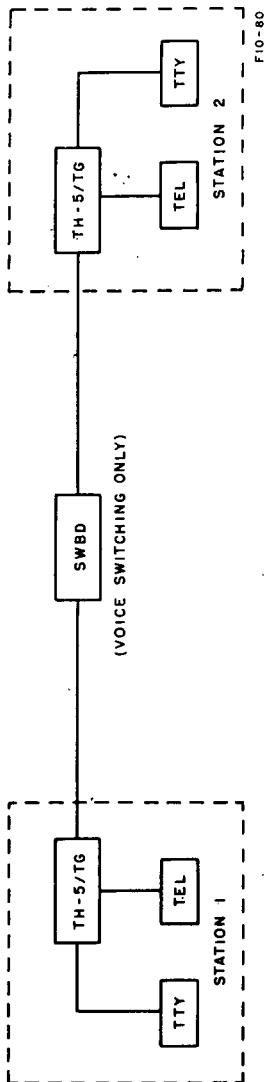

Figure 93. Alternate telegraph-telephone service on switchboard loop circuit, using Telegraph Terminal TH-5/TG.

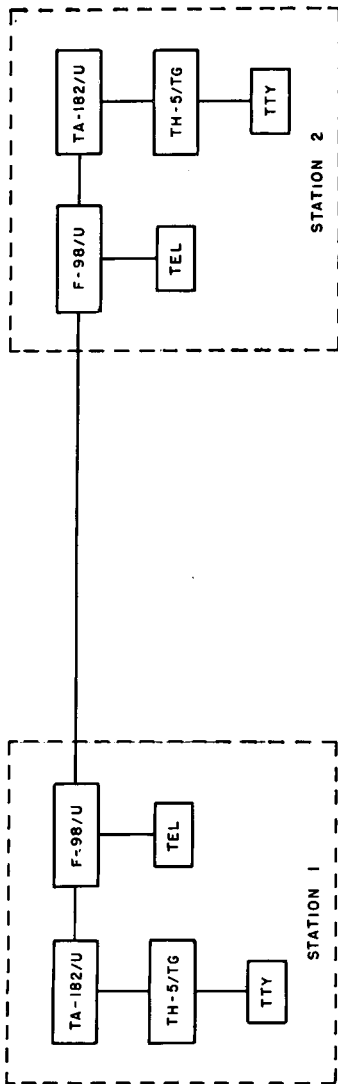

FIG-38

Figure 94. Simultaneous service on point-to-point circuit, using Telegraph-Telephone Terminal AN/TCC-14.

and telephone transmission. Refer to TM 11-2239 for detailed installation instructions and illustrations.

Section VII. TERMINALS

109. Terminal Box TA-125/GT

a. Terminal Box TA-125 (fig. 95) is a small light-weight terminal box. It is used at wire heads and test points where weatherproof terminations are essential for uninterrupted service. The terminal box is used wherever rapid installation of field wire or cable circuits are required. It also may be used as a main distributing frame for Manual Telephone Switchboards SB-22/PT and SB-86/P.

b. Terminal Box TA-125/GT contains 48 binding post assemblies and 48 pin jacks. To insert the bare end of field wire, the binding posts must be pushed in. A row of 12 slots located on each side of the box provides an entrance for the wire pairs. A row of 24 screwdriver slotted switches are located at the center of the box. These lugs are turned to open or close the electrical contact between the corresponding binding posts. The pin jacks are used for insertion of the test prods of Maintenance Kit MX-842/GT (par. 110).

c. For further information, refer to TM 11-2138.

110. Maintenance Kit MX-842/GT

a. Maintenance Kit MX-842/GT (fig. 96) consists of two Test Prods MX-1315/U, four Electrical Cord Assemblies CX-1959/U, three Switchboard Signals TA-123/GT, and a carrying case. It is designed for use with Terminal Box TA-125/GT (par. 109) and

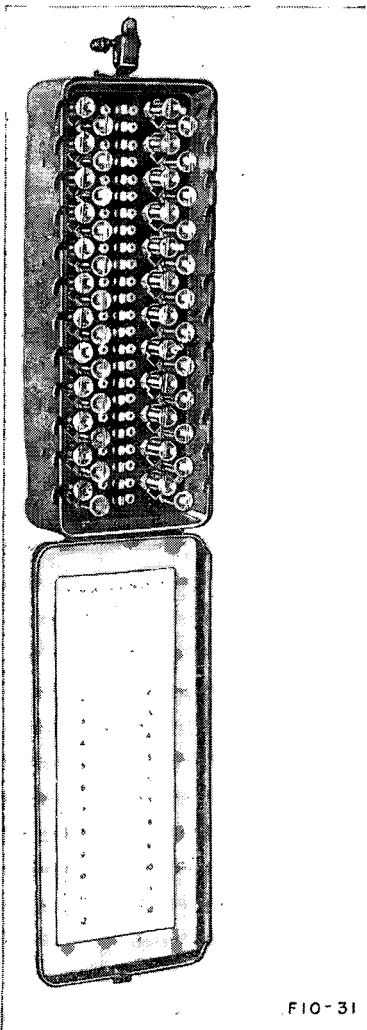

FIG-31

Figure 95. Terminal Box TA-125/GT.

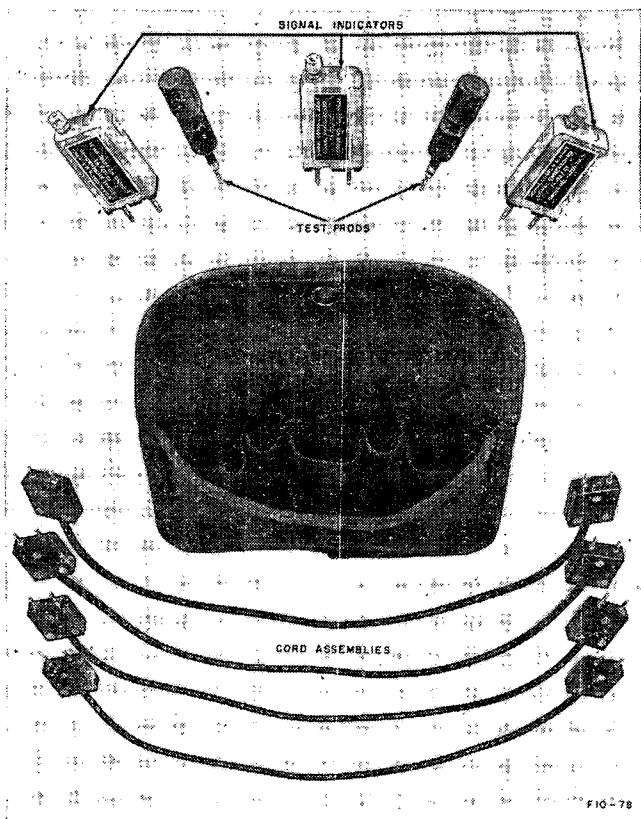

Figure 96. Maintenance Kit MX-842 GT.

Telephone Repeating Coil Assembly TA-145/GT (par. 114).

b. The components of Maintenance Kit MX-842/GT when used with Terminal Box TA-125/GT and Telephone Repeating Coil Assembly TA-145/GT, permit the terminating circuits to be tested, moni-

tored, switched, patched, simplexed, or phantomd as required.

c. Maintenance Kit MX-842/GT is described in detail in TM 11-2138.

111. Terminal Strip TM-184

Terminal strips are used as terminating or test points in tactical field-wire systems. Terminal Strip TM-184 (fig. 97) consists of an insulator board on

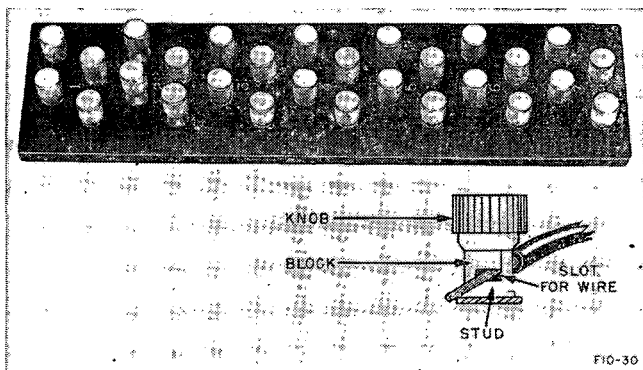

Figure 97. Terminal Strip TM-184.

which are mounted 28 insulation-piercing binding posts. It is equipped with two mounting clamps and four mounting holes. This terminal strip can terminate seven pairs of wires.

Section VIII. REPEATING COILS

112. General

a. A repeating coil is an audio-frequency transformer (usually with a one-to-one winding ratio) used to transfer energy from one electrical circuit

to another, and to permit the formation of simplexed and phantomed circuits for additional teletypewriter or telephone channels. The coils consist of two balanced windings. One winding—the line side—is connected to line terminals. The other winding—the switchboard side—is connected to switchboard terminals. If a telephone is used instead of a switchboard, these windings are connected to the telephone. The line side of the coil is tapped at the midpoint. This tap provides a connection for additional circuits. (See fig. 98.)

b. Additional circuits can be obtained from existing metallic circuits by the use of repeating coils (figs. 98 and 102). These circuits are as follows:

- (1) A *Simplex circuit* (figs. 99 and 103) is one in which a ground-return telephone or telegraph circuit is superimposed on (added to) a single, full-metallic circuit to obtain an additional circuit.
- (2) A *Phantom circuit* (fig. 100 and 104) is obtained from two full-metallic circuits to provide an additional telephone or telegraph circuit.
- (3) A *Simplexed-phantom circuit* (fig. 101 and 105) combines the principles of both simplex and phantom circuits to obtain a fourth circuit.

c. Mutual interference between the different circuits, or group) of a simplexed or phantomed wire line will result if the circuits are unbalanced (do not have the same impedance). The amount of interference will depend on the degree of unbalance between the two metallic circuits. The primary causes

of unbalance are poor splices that introduce a high resistance into either side of the circuit, and improperly taped splices or damaged portions of insulation which when wet, causes excessive leakage from one side of the circuit to ground. Although it is extremely difficult to obtain perfect balance in field-wire circuits, mutual interference can be reduced considerably by overhead construction, by making each wire pair of a simplexed or phantom group the same length, and by making sure that all splices are made properly.

d. Usually more mutual interference results from a phantom group than from a simplexed circuit since more circuits are involved in the phantom group. A phantom circuit should be used in field-wire systems only when an additional speech channel is required. (Simplexed circuits are most commonly used to provide teletypewriter as well as additional speech channels.)

e. Field test repeating coils by connecting the coils with a short length of field wire in the same circuit arrangement as that in which the coils will be used. This circuit arrangement should also include the terminal equipment. After the equipment is connected together, make an operational test.

113. Coil C-161 (REPEATING)

Coil C-161 (fig. 98) is a ring-through transformer having a one-to-one winding ratio with the line-side winding tapped at the center for simplex- or phantom-circuit operation. The LINE binding posts are connected directly to the line. The SWITCHBOARD binding posts are connected to the line

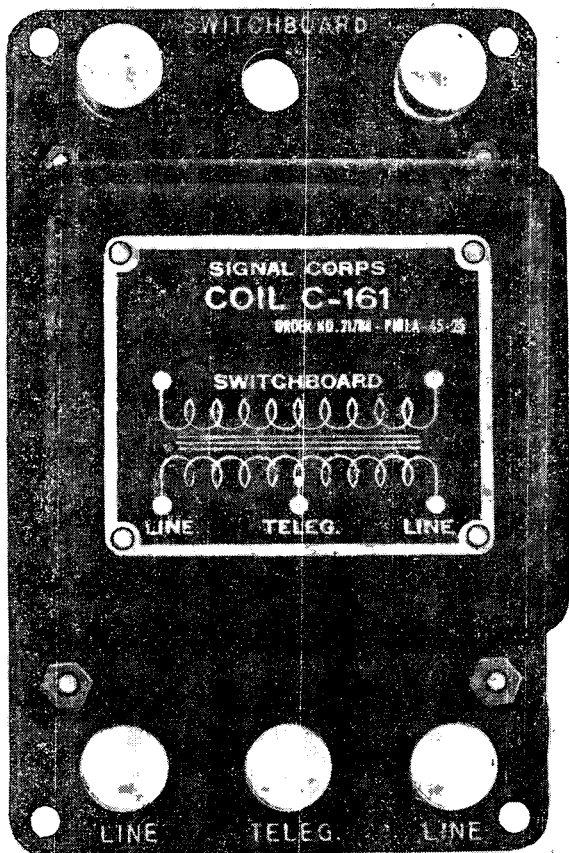

F10 - 34

Figure 98. Coil C-161 (repeating).

terminals on a switchboard or telephone. The TELEG. binding post is connected to one line terminal of a teletypewriter (except in a phantom circuit where it is connected to the switchboard binding posts of the repeating coil). Figures 99 through 101 show different circuit arrangements using Coil C-161.

114. Telephone Repeating Coil Assembly TA-145/GT

a. Telephone Repeating Coil Assembly TA-145/GT (fig. 102) is a small, lightweight, weatherproof unit consisting of a row of 12 pairs of binding posts, a row of pin jacks, and 4 repeating coils attached to the terminal board. There are four sets of binding posts (six binding posts in each set). In each set, the top two (diagonally adjacent) binding posts are marked SWBD; the next two are marked LINE; one of the last two is marked TG, and the other GND. The binding post connections are similar to those for Coil C-161 (fig. 98). The binding posts are pushed in to insert the bared ends of the field wire. There are 24 pin jacks, each connected to its associated binding post. The box for this unit has 12 slots on one side for the entrance of the field-wire pairs. Circuit arrangements using these repeating coils are shown in figures 103, 104, and 105.

b. For further information, refer to TM 11-2138.

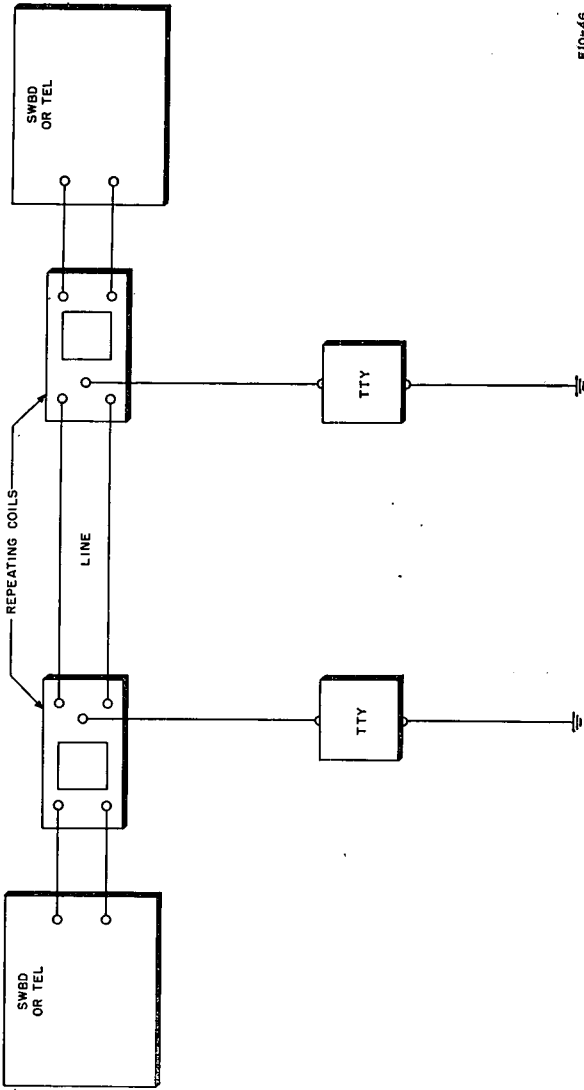
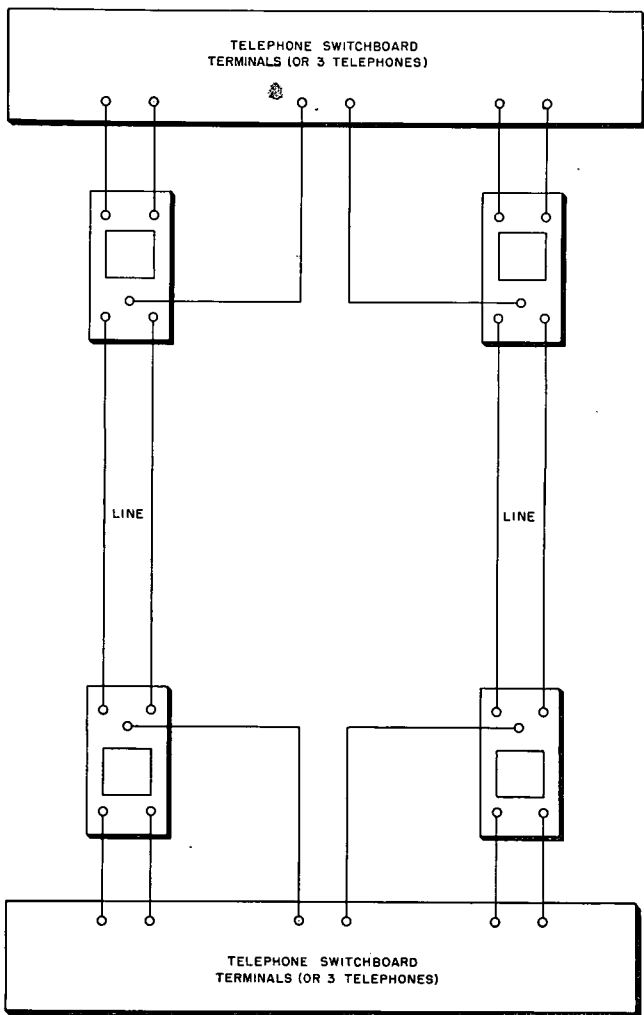

Figure 99. Simplex circuit, using Coil C-161.



F10-47

Figure 100. Phantom circuit, using Coil C-161.

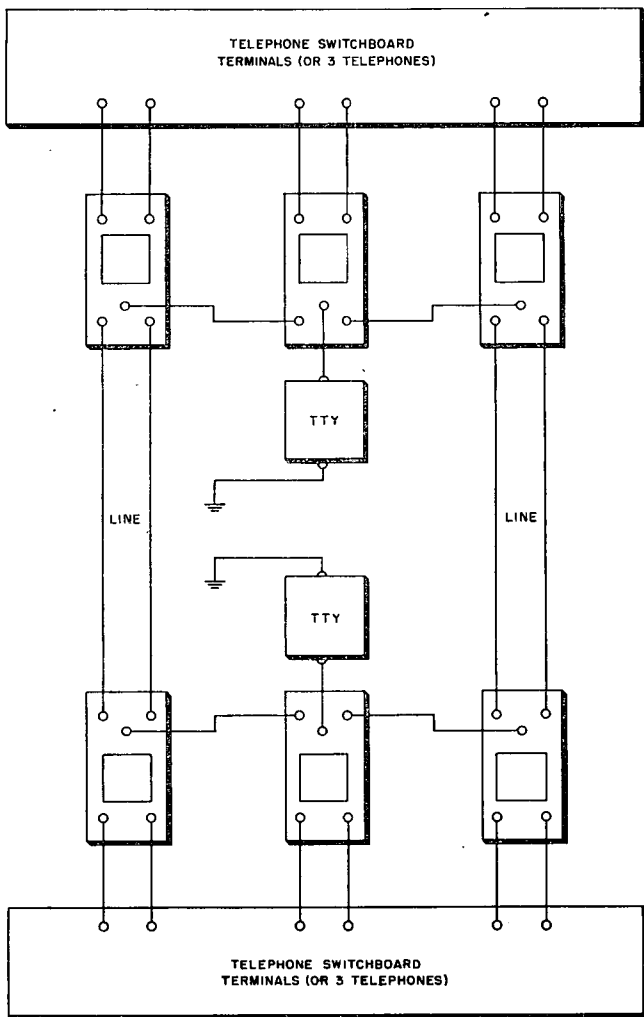

FIG-48

Figure 101. Simplex-phantom circuit, using Coil 161.

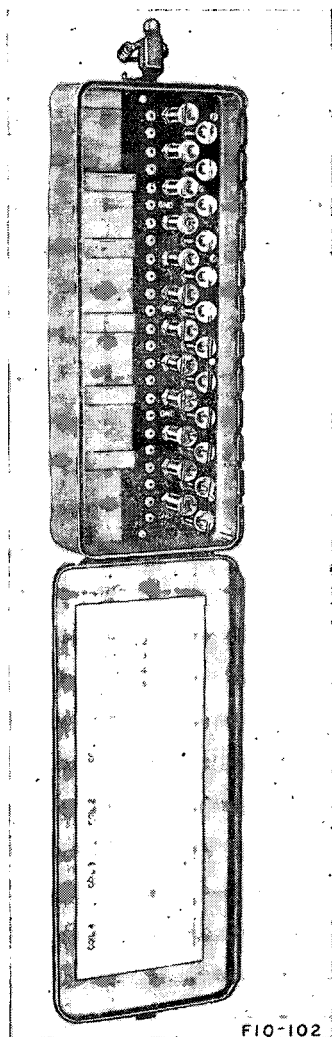

Figure 102. Telephone Repeating Coil Assembly
TA-145/GT.

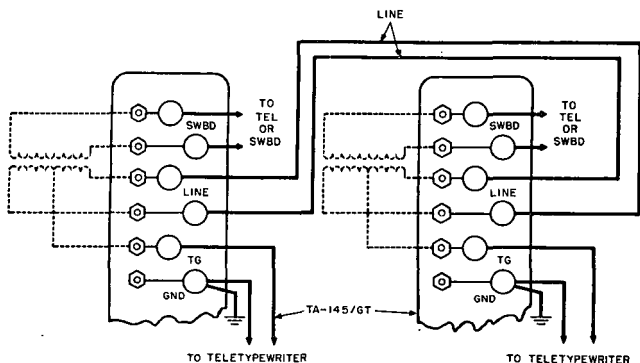

FIG-49

Figure 103. Simplex circuit constructed with Telephone Repeating Coil Assembly TA-145/GT.

Section IX. TEST EQUIPMENT

115. General

a. Various types of specialized testing equipment are used to test different types of lines in a communication system. Testing equipment enables the tester to conduct, with speed and accuracy, the various tests necessary to install and maintain an efficient communication system.

b. Test instruments are delicate, precision devices and require careful handling while being transported or operated. The tester should be familiar with each test set and observe all required safety measures during the performance of any test.

c. Precautionary safety measures must be taken when making tests on field-wire lines, because the lines under test might be crossed with high-tension power lines. Carelessness could prove fatal to the tester. *Always handle lines suspected of carrying*

high voltages with extreme caution and wear rubber gloves. If rubber gloves are not available, cover your hands with material having high insulating quality before handling the wires. Wire lines can be tested for high voltage before connecting the wires to a test set by briefly touching the bare end of one conductor against the end of the other; and also by touching the ends of each wire to a ground. There should be an arc or spark if high voltages are present.

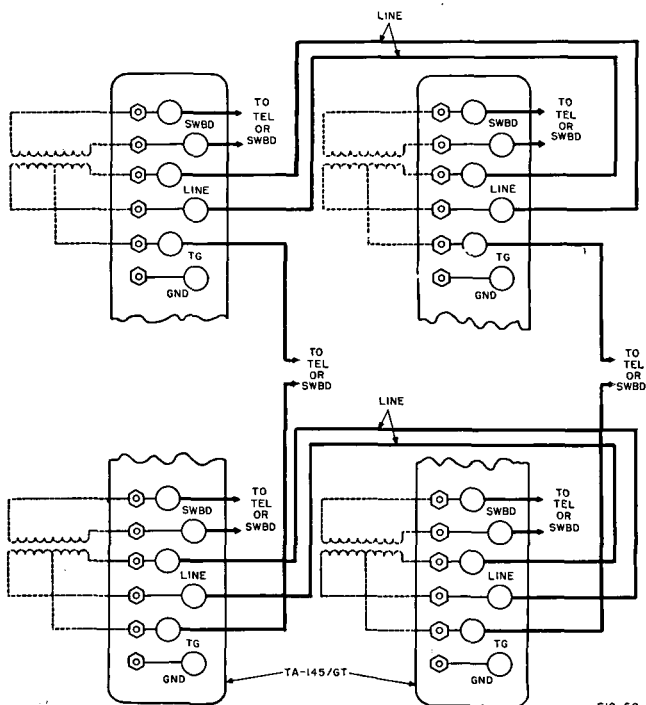

FIG-50

Figure 104. Phantom circuit constructed with Telephone Repeating Coil Assembly TA-145/GT.

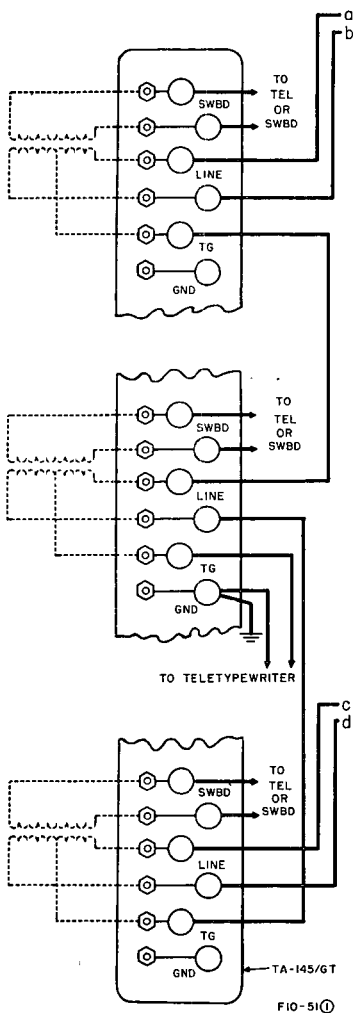
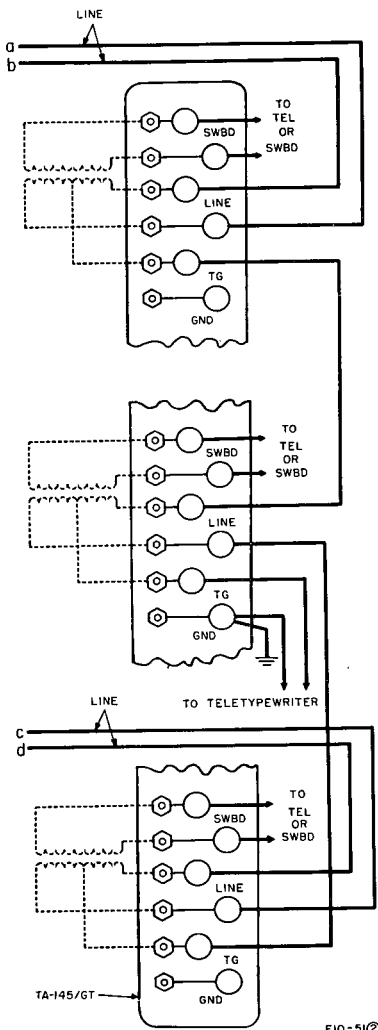

Figure 105. Simplex-phantom circuit constructed with Telephone Repeating Coil Assembly TA-145/GT.



F10-51(2)

Figure 105—Continued.

116. Multimeter TS-297/U

Multimeter TS-297/U (fig. 106) is a pocket-sized multirange test instrument for measuring voltage, direct current, and resistance. It is used for general purpose testing of electrical and electronic equipment. Complete operating instructions are contained in TM 11-5500.

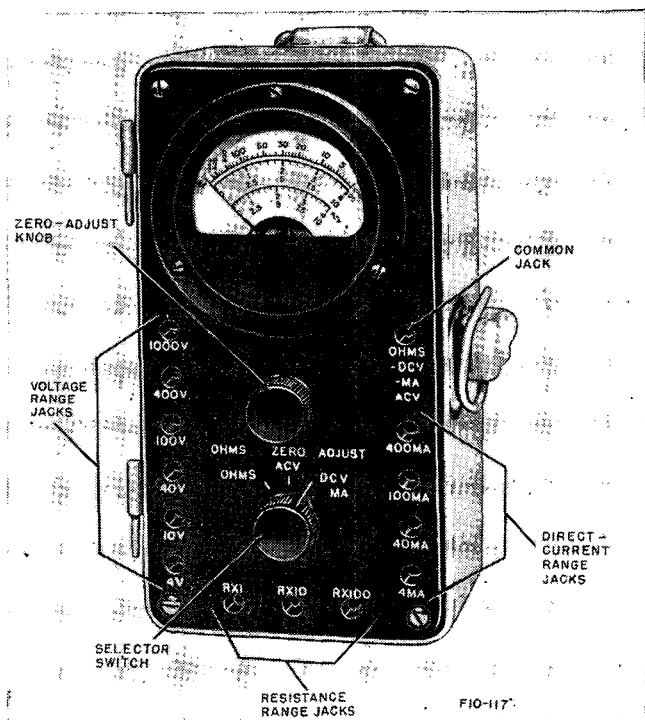

Figure 106. Multimeter TS-297/U.

117. Resistance Bridge ZM-4()/U

Resistance Bridge ZM-4()/U (fig. 107) is a portable direct-reading Wheatstone bridge used to trouble shoot and locate defects in a circuit. It can

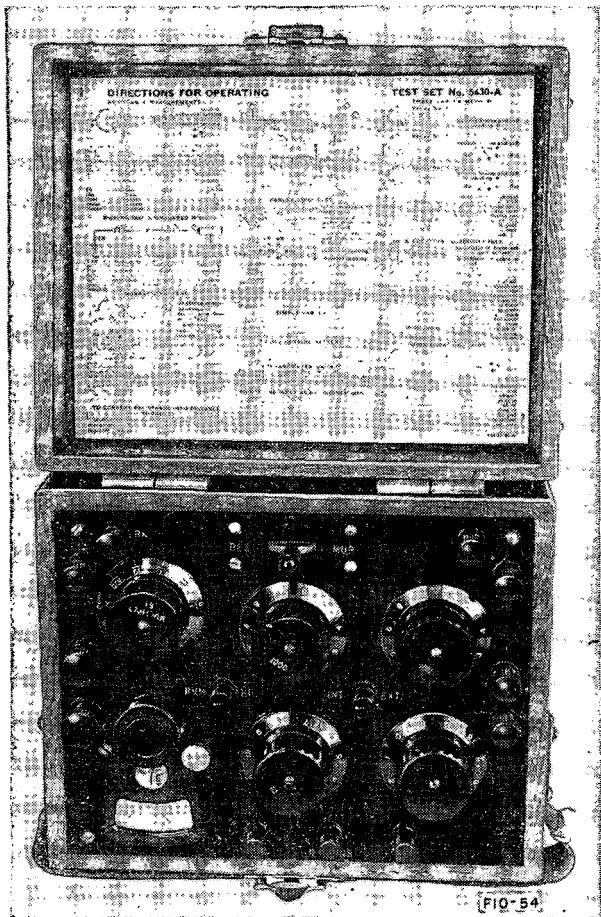

Figure 107. Resistance Bridge ZM-4()/U.

be used to determine the size of unknown resistance and serve as an auxiliary resistance box. Complete operating instructions are contained in TM 11-2019.

118. Test Set TS-27B/TSM

a. Test Set TS-27B/TSM (fig. 108) is a form of Wheatstone bridge powered by dry-cell batteries. It is used for measuring capacitance, conductor and insulation resistances, and for locating grounds,

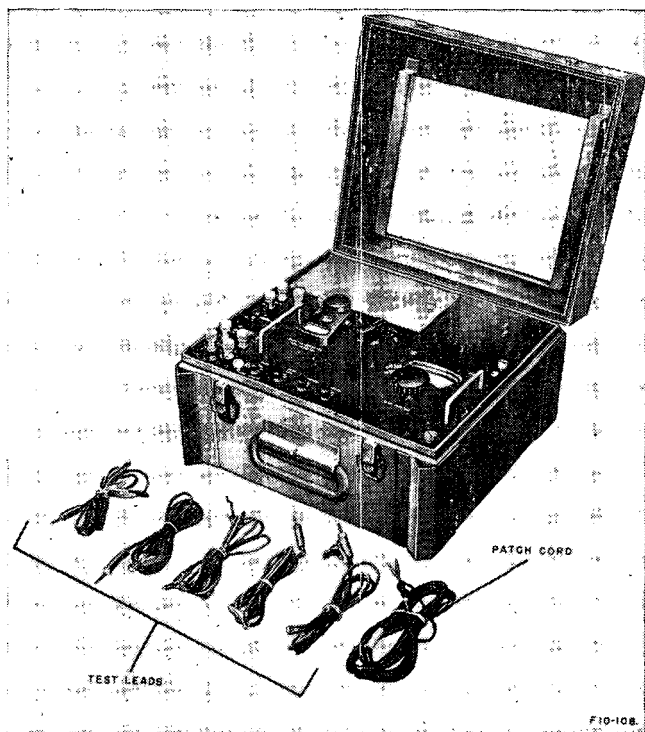

Figure 108. Test Set TS-27B/TSM.

opens, crosses, and shorts. When the test set is used for measuring capacitance and for locating opens, a 20-cps signal is supplied by a vacuum-tube oscillator circuit. This unit is contained in a portable, water-tight carrying case complete with accessories. Complete operating instructions are contained in TM 11-2057A.

119. Test Set TS-26()/TSM

Test Set TS-26()/TSM (fig. 109) is a portable voltohmmeter used for determining and locating grounds, crosses, shorts, and opens in tactical wire communication systems. It can be used to measure insulation and conductor resistances and dc voltages. The unit can also be used for locating opens by the capacitance-kick method. The test set consists of a meter panel assembly and a switch panel assembly. Both panel assemblies are mounted in a carrying case. A storage compartment is provided for the two test leads. Complete operating instructions are contained in TM 11-2017.

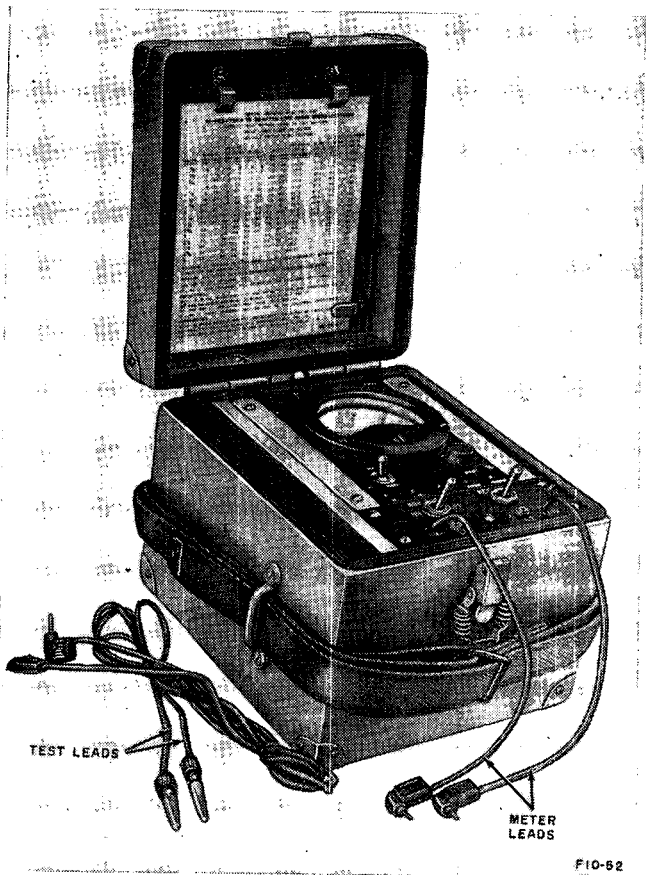

Figure 109. Test Set TS-26 ()/TSM.

CHAPTER 9

TELEPHONE SWITCHBOARD OPERATION

120. General

Telephone switchboard operators must, at all times, furnish service with the least possible delay, confusion, or annoyance to the telephone users. This requires that operators be skilled and thoroughly trained to follow the approved operating procedures.

121. Procedures

Voice procedures (expressions and phrases) used in the operation of switchboards are discussed in detail in *Telephone Switchboard Operating Procedure ACP 134 (A)*.

122. Manual Operation

a. The switchboard operational instructions are contained in the associated technical manual for each specific equipment.

b. A field telephone switchboard can be used to switch voice-frequency (vf) teletypewriter circuits. In this case, the operator must know the correct teletypewriter procedures (refer to ACP-126). The instructions for vf teletypewriter circuit switching are contained in TM 11-2239.

123. Traffic Diagram

a. *General.* A traffic diagram is an illustration showing the number of telephone (fig. 110) or tele-

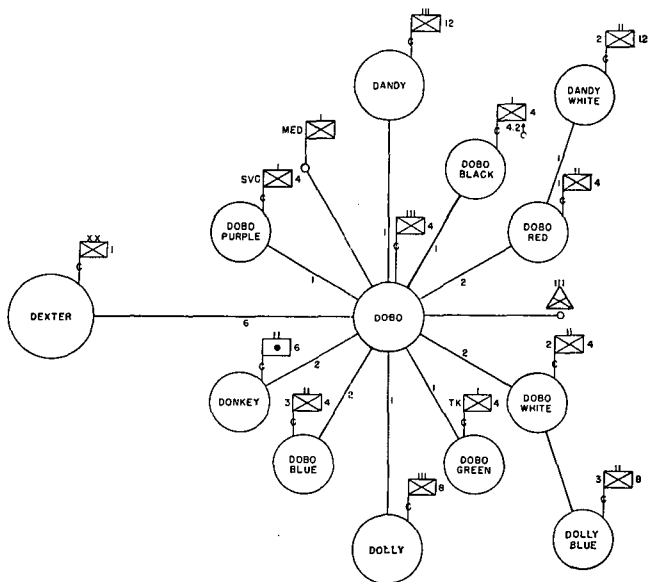

TELEPHONE TRAFFIC DIAGRAM				
4TH INF REGT				
AS OF 1955, 4 JUN 55				
ACTION	DATE	SIGNATURE	GRADE	TITLE
PREPARED	JUN	C.G. Smith	SFC	SIG TRANSM
CHECKED	JUN	J.G. Jones	MSGT	COMM OFFIC
APPROVED	JUN	F.G. Brown	CAPT	COMM O

FIG-8

Figure 110. Example of telephone traffic diagram.

typewriter circuits (fig. 111) existing between switching centrals of a wire system. Long-local circuits may also be shown. Traffic diagrams are used by the switchboard operators to route telephone calls through the wire system.

b. Preparation. Telephone traffic diagrams (fig. 110) are prepared at each switching central. A single line on the traffic diagram denotes a direct com-

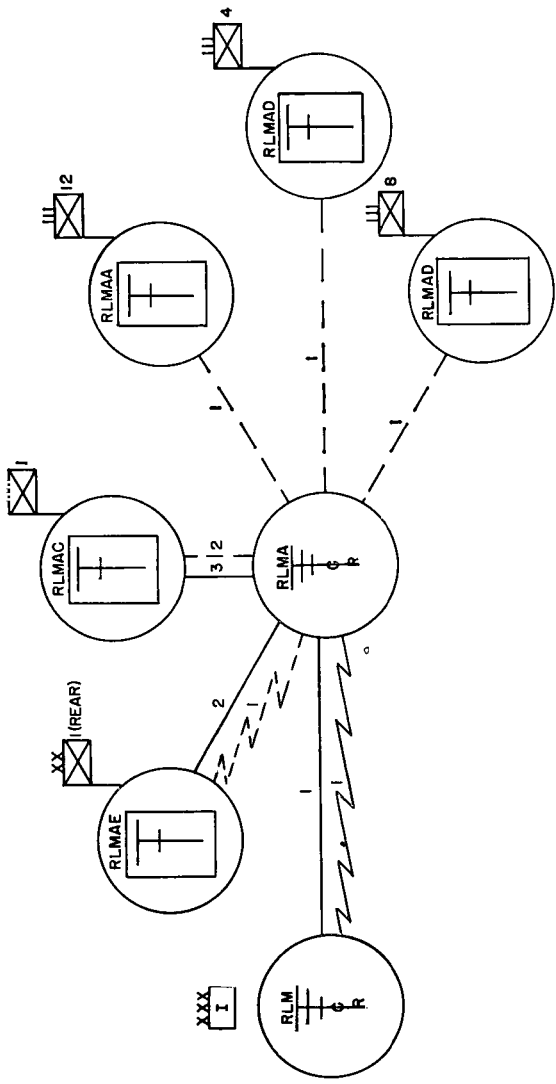

TELETYPEWRITER TRAFFIC DIAGRAM				
1ST INF DIV				
AS OF 1800, 4 JUN 55				
ACTION	DATE	SIGNATURE	GRADE	TITLE
PREPARED	4 JUN	Carl E. Becker	1st Lt	CHTROP
CHECKED	5 JUN	T. J. Feilner	1st Lt	OPUSO
APPROVED	5 JUN	D. Q. Bordale	1st Col.	DSO

Figure III. Example of a teletypewriter diagram.

munication. A numeral placed on the line indicates the number of channels available, including simplex, phantom, and carrier circuits. Separate diagrams are prepared for teletypewriter and telephone channels even though the same wire lines are used for both. Traffic diagrams must be corrected continuously as changes occur and expanded as new information is obtained.

c. Security. Local security measures will determine the extent of information that will be placed on traffic diagrams.

124. Operating Records

a. The records, publications, printed forms, and other information maintained at any particular switchboard installation will depend on the type of telephone or teletypewriter switching central, and the local communications and security requirements.

b. The following is a typical list of publications that are normally made available to operators at switching controls:

Directory

Equipment manuals

Procedure directives (ACP's)

Phonetic alphabet

Station log

Test and trouble reports

Traffic diagram

APPENDIX I

REFERENCES

1. General

This appendix is a selected list of numbers and titles of publications, training films, and filmstrips pertinent to field wire installations. For availability of items and publications on additional subjects, refer to DA Pamphlets 108-1, 310-1, 310-3, and 310-4, and SR 310-20-7.

2. Army Regulations

- AR 105-15----- Field Signal Communications.
- AR 380-5----- Safeguarding Defense Information.
- AR 750-5----- Maintenance Responsibilities and Shop Operations.

3. Field Manuals

- FM 21-30----- Military Symbols.
- FM 24-5----- Signal Communication.

4. Filmstrips

- FS 11-22----- Maintenance of Field Wire Circuits.
Part I: Prevention of Trouble.
- FS 11-23----- Maintenance of Field Wire Circuits.
Part II: Detection of Trouble.
- FS 11-24----- Maintenance of Field Wire Circuits.
Part III: Localization and Correction of Trouble.

- FS 11-29..... Telephone EE-8-A.
- FS 11-64..... Use of Repeating Coil C-161.
- FS 11-87..... Use of Loading Coil C-114 and
Telephone Repeater EE-S9-A.
- FS 11-101..... Field Wire Ties.
- FS 11-117..... Switchboard SB-22/Pt, Installa-
tion and Operation.

5. Modification Work Order

- MWO-SIG 74..... Modification of Axles RL-27-B
and RL-27-C to accommodate
Reel RL-159/U.

6. Supply Bulletin

- SB 11-189..... Modification of Pole Climbers
LC-5 and Tree Climbers LC-
21S/P.

7. Technical Bulletins

- TB 11-333-1..... Emergency Switchboard SB-18/
GT and Adapter Plug U-4/GT.
- TB SIG 13..... Moistureproofing and Fungiproof-
ing Signal Corps Equipment.
- TB SIG 66..... Winter Maintenance of Signal
Equipment.
- TB SIG 69..... Lubrication of Ground Signal
Equipment.
- TB SIG 75..... Desert Maintenance of Ground
Signal Equipment.
- TB SIG 243..... Long Span Construction of Wire
WD-1/TT.
- TB SIG 252..... Use of Electrical Insulation Tapes
TL-600/U and TL-636/U.

8. Technical Manuals

- TM 11-333..... Telephones EE-S, EE-S-A and
EE-S-B.
- TM 11-337..... Telephone Set TA-43/Pt.

TM 11-360	Reel Units RL-26-A, RL-26-B, and RL-26-C.
TM 11-362	Reel Units RL-31, RL-31-B, RL-31-C, RL-31-D, and RL-31-E.
TM 11-369	Cable Assembly CC-358, Cable Assembly CC-368 and Cable Stub CC-356 (Spiral Four).
TM 11-371	Cables WC-534 (5 pair), WC-535 (10 pair), and Cable Assemblies CC-345 and CC-355-A.
TM 11-381	Cable Assembly CX-1065/G, Telephone Cable Assemblies CX-1606/G and CX-1512/U, and Telephone Loading Coil Assembly CU-260/G.
TM 11-462	Signal Corps Tactical Communication Reference Data.
TM 11-655	Fundamentals of Telegraphy (Teletypewriter).
TM 11-661	Electrical Fundamentals (Direct Current).
TM 11-678	Fundamentals of Telephony.
TM 11-680	Teletypewriter Circuits and Equipment (Fundamentals).
TM 11-681	Electrical Fundamentals (Alternating Current).
TM 11-757	Principles of Line Fault Location.
TM 11-2006	Telephone Repeater EE-89-A.
TM 11-2007	Telephone Repeater TP-14.
TM 11-2017	Test Sets TS-26/TSM and TS-26A/TSM and TS-26B/TSM.
TM 11-2019	Test Set I-49 and Resistances Bridges ZM-4A/U and ZM-4B/U.
TM 11-2043	Telephone TP-3.
TM 11-2057	Test Set TS-27/TSM.
TM 11-2057A	Test Set TS-27B/TSM.

- TM 11-2059----- Telephone TP-9 and TA-264/PT.
 TM 11-2134----- Manual Telephone Switchboard
 SB-86/P Installation and Oper-
 ation.
 TM 11-2135----- Telephone Repeater TA-126/GT.
 TM 11-2137----- Telegraph-Telephone Signal Con-
 verter TA-182/U.
 TM 11-2138----- Terminal Box TA-125/GT; Tele-
 phone Repeating Coil Assembly
 TA-145/GT; Maintenance Kit
 MX-842/GT; and Switchboard
 Signal TA-123/GT.
 TM 11-2202----- Manual Telephone Switchboard
 SB-22/PT.
 TM 11-2225----- Teletypewriter Set AN/GGC-3
 and Teletypewriter Reperfora-
 tor-Transmitter TT-76/GGC.
 TM 11-2235----- Teletypewriter Set AN/PGC-1.
 TM 11-2239----- Telegraph - Telephone Terminal
 AN/TCC-14.
 TM 11-2240----- Wire Dispenser MX-306A/G.
 TM 11-2250----- Reel Equipment CE-11.
 TM 11-2262----- Open Wire Pole Lines; Construc-
 tion and Maintenance.
 TM 11-5500----- Multimeter TS-297/U.

9. Training Films

- TF 11-590----- Climbing and Working on Poles.
 TF 11-1199----- Use of Field Telephone.
 TF 11-1488----- Communication in the Infantry
 Regiment.
 TF 11-1564----- Field Wire Splices.
 TF 11-1635----- Field Wire Ties.
 TF 11-1637----- Field Wire Laying Equipment.
 TF 11-2062----- Theory of Simplex and Phantom
 Circuits.
 Part I: Balanced Conditions.

TF 11-2063----- Theory of Simplex and Phantom
Circuits.
Part II: Unbalanced Condi-
tions.

10. Other Publications

ACP 134 (A) ----- Telephone Switchboard Operating
Procedure (nonregistered).

APPENDIX II

SPECIAL SYMBOLS USED IN WIRE DIAGRAMMS AND MAPS

Special symbols are used in signal communication on tactical circuit diagrams, line route maps, and traffic diagrams. To clarify certain symbols, it might often be necessary to include the equipment type number with the symbols. The application of these symbols are shown in figures 64, 65, 110, and 111. For additional information on symbols, refer to FM 21-30, Military Symbols; and TM 11-462, Signal Corps Tactical Communication Reference Data.

1. Basic Symbols Used in Traffic Diagrams

TELEPHONE
(MILITARY SYMBOLS OF THE USING UNITS OR INSTALLATIONS ARE PLACED ABOVE THE SYMBOL.)



TELEPHONE SWITCHING CENTRAL
(SWITCHBOARD CODE NAMES ARE PLACED WITHIN THE CIRCLE. MILITARY SYMBOLS OF UNIT OR INSTALLATIONS MAY ALSO BE SHOWN WHEN SECURITY MEASURES PERMIT.)

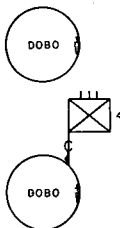

CHANNELS LINKING TELEPHONE TERMINALS
(THE NUMERAL ABOVE THE LINE INDICATES THE NUMBER OF AVAILABLE CHANNELS.)

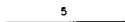

TELETYPEWRITER SET
(IDENTIFYING NAMES OR CALL SIGNS ARE PLACED WITHIN THE CIRCLE.)



TELETYPEWRITER SWITCHING CENTRAL



TELETYPEWRITER SWITCHING CENTRAL INCLUDING TAPE RELAY FACILITIES
(IDENTIFYING NAMES OR CALL SIGNS ARE PLACED WITHIN THE CIRCLE.)



CHANNELS LINKING TELETYPEWRITER TERMINALS
(THE NUMERAL ABOVE THE LINE INDICATES THE NUMBER OF AVAILABLE CHANNELS.)

WIRE (OR RADIO RELAY), FULL-DUPLEX OPERATION



WIRE (OR RADIO RELAY), HALF-DUPLEX OPERATION



RADIOTELETYPE, FULL-DUPLEX OPERATION



RADIOTELETYPE, HALF-DUPLEX OPERATION

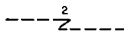

FIG-99

2. Basic Symbols Used in Tactical Circuit Diagrams

TELEPHONE (SMALL CIRCLE)



TELETYPEWRITER, PAGE PRINTING



TELETYPEWRITER, TAPE ONLY



FACSIMILE



TEST STATION OR WIRE HEAD

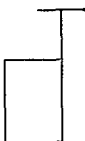

TELEPHONE SWITCHING CENTRAL
(ALSO USED WHEN SWITCHBOARD PROVIDES ALTERNATE OR SIMULTANEOUS
TELEPHONE AND TELETYPEWRITER SERVICE.)

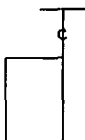

TELEPHONE SWITCHING CENTRAL AT A COMMAND POST OR HEADQUARTERS
(ALSO USED WHEN SWITCHBOARD PROVIDES ALTERNATE OR SIMULTANEOUS
TELEPHONE AND TELETYPEWRITER SERVICE.)

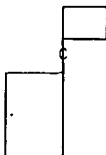

TELEPHONE SWITCHING CENTRAL AT COMMAND POST OR HEADQUARTERS WITH
SEPARATE SWITCHBOARD FOR TELETYPEWRITER AND WITH TAPE RELAY
FACILITIES

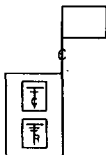

F10-103A

TELETYPEWRITER SWITCHING CENTRAL

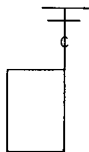

A SINGLE-CONDUCTOR GROUND-RETURN CIRCUIT GROUNDED THROUGH COMMUNICATION EQUIPMENT



OR



REPEATING COIL IN A SIMPLEX CIRCUIT



FIELD-WIRE PAIR OR CABLE
(CABLE TYPE IS INDICATED ABOVE LINE WITHIN PARENTHESIS)

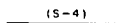

RADIO CHANNEL

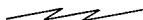

CIRCUIT NOT TERMINATED



RADIO LINK IN A WIRE LINE

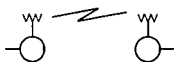

WIRE LINES CONNECTED ELECTRICALLY



FIELD-WIRE OR CABLE CROSSING



EQUIPMENT FOR DERIVING ADDITIONAL CHANNELS FROM CIRCUITS
(EQUIPMENT TYPE NUMBER IS INDICATED NEAR SYMBOL.)

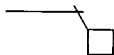

TH-5

UNATTENDED REPEATER
(THE NUMBER OF LINES TO EACH SIDE OF THE SYMBOL WILL VARY DEPENDING ON THE REPEATER TYPE AND ITS USE.)



ATTENDED REPEATER
(THE NUMBER OF LINES TO EACH SIDE OF THE SYMBOL WILL VARY DEPENDING ON THE REPEATER TYPE AND ITS USE.)

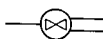

FIG-1038

3. Basic Symbols Used in Line Route Maps









TELEPHONE (SMALL CIRCLE)	
TELETYPEWRITER, PAGE PRINTING	
TELETYPEWRITER, TAPE ONLY	
FACSIMILE	
RADIO TERMINAL	
RADIO RELAY STATION	
FIELD-WIRE LINE OR FIELD CABLE ON GROUND (THE NUMERAL INDICATES THE NUMBER OF FIELD WIRE PAIRS OR FIELD CABLES.)	
INDIVIDUAL FIELD-WIRE PAIRS OR CABLES TIED TOGETHER TO FORM A SINGLE CABLE (THE NUMERAL INDICATES THE NUMBER OF FIELD-WIRE PAIRS OR CABLES. CABLE TYPES ARE ADDED IN PARENTHESIS.)	
FIELD-WIRE LINE OR CABLE, UNDERGROUND	
FIELD-WIRE LINE OR CABLE, NOT TERMINATED	
FIELD-WIRE LINE SPLICED INTO ANOTHER LINE	
TWO FIELD-WIRE LINES JOINING TOGETHER AND FOLLOWING SAME ROUTE (NOT SPLICED)	
FIELD-WIRE LINE CROSSING ANOTHER LINE	

FIG-104A

REPEATING COIL, SIMPLEXED IN A LINE

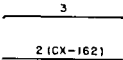
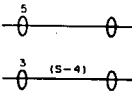
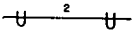

FIELD-WIRE LINE OR CABLE ON OVERHEAD SUPPORTS

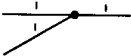
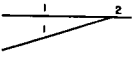
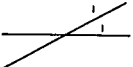
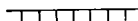

UNATTENDED REPEATER



ATTENDED REPEATER

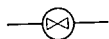

F10-1043

APPENDIX III

PHONETIC ALPHABET

Note. Information in paragraphs 2 and 3 will be effective 1 March 1956.

1. General

Certain letters of the alphabet have similar sounds and often are confused in telephone conversations. To avoid this difficulty, the use of words representing the alphabet and the pronunciation of numbers prescribed in the paragraphs 2 and 3 below are necessary for all voice communication.

2. US Military Services Phonetic Alphabet

<i>Letter</i>	<i>Spoken as</i>	<i>Letter</i>	<i>Spoken as</i>
A.....	ALFA	N.....	NOVEMBER
B.....	BRAVO	O.....	OSCAR
C.....	CHARLIE	P.....	PAPA
D.....	DELTA	Q.....	QUEBEC
E.....	ECHO	R.....	ROMEO
F.....	FOXTROT	S.....	SIERRA
G.....	GOLF	T.....	TANGO
H.....	HOTEL	U.....	UNIFORM
I.....	INDIA	V.....	VICTOR
J.....	JULIETT	W.....	WHISKEY
K.....	KILO	X.....	X-RAY
L.....	LIMA	Y.....	YANKEE
M.....	MIKE	Z.....	ZULU

3. Pronunciation of Numerals

<i>Nu- meral</i>	<i>Spoken as</i>	<i>Nu- meral</i>	<i>Spoken as</i>
0----	ZE-RO	7----	SEV-en
1----	WUN	8----	AIT
2----	TOO	9----	NIN-er
3----	TREE	100--	WUN HUN-DRED
4----	FOW-er	1000-	WUN THOW- ZAND
5----	FIFE		
6----	SIX		

4. Using Phonetic Alphabet and Numerals

a. Letters. Words of the phonetic alphabet are spoken in place of the letters they represent. If a word might be misunderstood, spell it out phonetically. For example: "DANDY—I SPELL DELTA, ALFA, NECTAR, DELTA, YANKEE—DANDY." The encrypted group SPWXT is spoken as "SIERRA, PAPA, WHISKEY, EXTRA, TANGO."

b. Numerals. Each digit of a large number is pronounced separately, except in the case of even hundreds and even thousands when the word hundred or thousand is used. For example: DOBO 19 is spoken as DO-BO WUN NIN-er; DEXTER 6100 is spoken as DEX-TER SIX WUN HUN-DRED; and DOLLY 36000 is spoken as DOL-LY TREE SIX THOW-ZAND.

APPENDIX IV

TELEPHONE DIRECTORY

1. General

The purpose of a telephone directory is to simplify and expedite telephone switching service. To fulfill this purpose a telephone directory must be compiled accurately and it must contain both the users' names and their assigned numbers. A telephone directory should be used consistently and correctly by all telephone operators and telephone users.

2. Contents

There are two main parts to a military telephone directory: directory code names and directory numbers. In field operations, both the names and numbers are issued as one item of the SOI.

3. Directory Names

a. Telephone directory code names are assigned to all units normally equipped with a switchboard. Code names are not meant to provide security but are used to speed up telephone service. These names are permanent; they are changed only when there is a chance of confusion with directory names of other units. Telephone directory names must not be used to refer to units in messages or in conversations. Typical directory code names are as follows:

<i>Telephone central</i>	<i>Directory code name</i>
1st Infantry Division.....	Dexter
1st Infantry Regiment.....	Dobo
8th Infantry Regiment.....	Dolly
12th Infantry Regiment.....	Dandy
12th Artillery Battalion.....	Donkey

b. The colors listed below when used with the directory code names could refer to various components of the units as follows:

Red.....	1st Battalion
White.....	2d Battalion
Blue.....	3d Battalion
Green.....	Tank Company
Black.....	Mortar Company
Purple.....	Service Company

Example: Dobo Black—Mortar Company, 1st Infantry Regiment.

4. Directory Numbers

Directory numbers are assigned to the local telephones installed within a command. Directory numbers, once assigned, remain fixed. These numbers are issued as separate items from the code name directory and are distributed to all telephone users. Following are typical examples of directory numbers.

<i>Number</i>	<i>Title</i>
1.....	G1 or S1.
2.....	G2 or S2.
3.....	G3 or S3.
4.....	G4 or S4.
5.....	Chief of Staff or Executive Officer.
6.....	Commanding Officer.
7.....	Adjutant (Division or higher units).
8.....	Ordnance Officer.
9.....	Inspector.

<i>Number</i>	<i>Title</i>
10.....	Signal or Communication Officer.
11.....	Message Center (incoming).
12.....	Message Center (outgoing).
13.....	Aide-de-camp.
14.....	Air Officer.
15.....	Enginer Officer.
16.....	Surgeon or Medical Officer.
17.....	Judge Advocate.
18.....	Finance Officer.
19.....	Chaplain.
20.....	Postal Officer.
21.....	Quartermaster (not Supply Officer).
22.....	Chief of Artillery or Artillery Officer.
23.....	Chemical or Gas Officer.
24.....	Liaison Officer.
25.....	Division Ammunition Office.
26.....	Pigeon Loft (if applicable).
27.....	Provost Marshal.
28.....	Radio Station.
29.....	Reconnaissance Officer.
30.....	Telegraph or Teletypewriter Office.
31.....	Telephone Wire Chief or Trouble Chief.
32.....	Veterinarian.
33.....	Public Telephone.
34.....	Headquarters Commandant.
35.....	Motor Officer.
36.....	Antitank Officer.
37.....	Special Service Officer.

GLOSSARY OF WIRE COMMUNICATION TERMS

Alternating current (ac)—An electric current that reverses its direction of flow at regular intervals.

Amplifier—A device used to increase the signal voltage, current, or power; used to increase the range of wire lines in repeater and carrier equipment.

Audio frequency (af)—A frequency that can be detected as sound by the human ear. The af range is approximately 30 to 20,000 cycles per second.

Axis of signal communication—A line or route on which lie the starting position and probable future locations of the command post of a unit during a troop movement; main route along which messages are transmitted and received from combat units in the field.

Bridged circuit—A circuit connected in parallel with an existing circuit.

Channel—Electrical path over which transmissions can be made from one station to another. A circuit may be composed of one or more channels.

Circuit—Communication link between two or more points capable of providing one or more communication channels.

Circuit marking tag—A tag which identifies a field-wire line or a field cable.

Command post—The tactical headquarters of a unit at which the commander and his staff are stationed. In combat, the headquarters of a unit is often di-

- vided into a forward echelon and a rear echelon. The forward echelon is called the command post.
- Common-battery signaling*—A telephone system in which the switchboard battery furnishes the power for operating the line and supervisory signals. The supervisory signals are controlled by the switch hook of the telephone. The power for speech transmission is provided by batteries in each telephone.
- Common-battery system*—A telephone system in which speech transmission current is supplied to the telephones from a central source.
- Common-battery telephone (Set)*—A telephone which is supplied with both signaling and speech transmission power from a central source.
- Communication means*—A medium through which a message is conveyed from one person or place to another.
- Conductor*—Any wire, cable, or other material that provides an electrical path for the flow of current.
- Construction center*—An installation located in or near a command post area where trunk lines and long-local circuits converge for entrance to the telephone central. Test equipment and construction personnel are usually located at this point.
- Cross*—An electrical contact between conductors of two independent circuits.
- Direct current (dc)*—An electric current that always flows in one direction.
- Echelon*—Subdivisions of a headquarters, as forward echelon, rear echelon; separate levels of command; as compared to regiment, division is a higher echelon, battalion is a lower echelon.

Fault—A defect in a wire circuit caused by grounding, a break in the circuit, a cross, or a short across a wire.

Field telephone—A portable telephone designed for field use.

Field telephone switchboard—A portable telephone switchboard designed for field use.

Field-type—Term used to describe equipment, troops, or units used primarily to carry out a combat mission.

Gain—Increase in signal power provided by an amplifier in a communication line; the ratio of the output power (voltage, current) to the input power (voltage, current).

Ground—The contact of a conductor with the earth; also refers to the physical earth when it is used as a conductor.

Lateral communication—Communication between units that are located side-by-side along a front; or communication between units at the same level of command.

Line route map—Map or overlay for signal communication operations that shows the actual route and type of constructions for tactical wire circuits.

Loaded line—A wire line in which loading coils have been inserted at regular intervals to reduce signal losses caused by the line capacitance.

Local-battery system—A telephone system in which the speech transmission power is supplied at each telephone.

Local circuit—A wire circuit connecting a telephone to a switchboard or to another telephone; sometimes called a loop.

Main distributing frame (MDF)—A framework containing terminals which are used for interconnecting incoming wire lines to the terminal equipment.

Manual telephone system—Telephone system in which interconnections are manually established by operators.

Map substitute—A quickly made reproduction of wide-coverage aerial photographs, photomaps, or mosaics, or of provisional maps, or any document used in place of a map. A map substitute does not necessarily meet the precise requirements of a map.

Marline—A small, loosely twisted twine used for tying field wire to a support.

Messenger strand—A steel cable used to support aerial communications cable.

Monocord switchboard—Field telephone switchboard in which each line terminates in a single jack and plug.

Open—A break in the continuity of a wire circuit.

Open-wire line—Parallel bare conductors strung on insulators mounted on cross arms of telephone poles.

Overlay—Transparent sheet giving special military information not ordinarily shown on maps. When the overlay is placed over the map from which it was drawn, its details will supplement the map; a tracing of a photograph, mosaic, or map which is used to present the interpreted features and the pertinent details, or to facilitate plotting of a certain area.

- Phantom circuit*—Telephone or telegraph circuit obtained by superimposing an additional circuit on two existing physical circuits by means of a repeating coil.
- Rear area*—General term designating the area in the rear of the combat and forward areas.
- Rear echelon*—That part of a headquarters engaged in administrative and supply duties. It is usually located at a considerable distance behind the front lines.
- Repeater*—A device for amplifying the retransmission of a signal.
- Repeating coil*—An audio-frequency transformer, usually with a one-to-one winding ratio, used for transferring energy from one electrical circuit to another, and for forming simplex and phantom circuits.
- Sag*—Sack placed in aerial wire or cable construction to compensate for contraction caused by weather conditions; the vertical distance between the lowest point on a line and the point of suspension.
- Section of wire line*—That portion of a wire line which begins and ends at successive centrals, testing points or, in the case of long-local circuit, at telephones.
- Seizing wire*—Soft-drawn copper wire which is wound over a field-wire splice to improve the splice mechanically and electrically.
- Short*—An electrical contact between two conductors of the same circuit.
- Skinning*—The process of removing insulation from wire.

Sound-powered telephone—A self-contained communication set which provides two-way signaling and voice communication over limited distances without the use of batteries. The sound-powered telephone may be, but usually is not, switched through a telephone central.

Spliced joint—A junction in which conductors of a circuit are joined for electrical continuity.

Staggering—The spacing of splices in the two conductors of a field wire in such a manner that the individual splices will not be opposite each other. This practice reduces the bulk of a splice and reduces the possibility of shorts.

Switching central—A wire-system installation in which switching equipment is used to interconnect teletypewriters or telephones.

Tactical—Pertains to the employment of units in combat.

Tactical circuit diagram—A line drawing of circuits of a communication wire net, showing the number, kind, and location of lines and all headquarters and subordinate units by code names and map coordinates. The extent of this information is determined by local security requirements.

Telegraphy—A means of communication whereby a message is transmitted by using a code of electrical impulses of various lengths and combinations to designate the individual characters. Teletypewriter transmissions are a form of telegraphy.

Terminal—One end of an electrical circuit. A terminal might also include the equipment at the end of the circuit.

Terminal strip—A block of insulating material to which several binding posts are fastened.

Test set—An electrical device used to determine and locate troubles in a circuit or equipment.

Test station—An installation where circuits can be tested and rearranged.

Traffic diagram—An illustration showing the number of long-local circuits and channels actually existing between the switchboards of a signal communication network.

Transmission—The flowing of electrical energy through a circuit.

Trunk—A circuit between two switchboards.

Twisted-wire pair—Two conductors of a wire line which are individually insulated and spirally wound around each other.

Voice-frequency (vf)—The band of frequencies generated by the human voice.

Way station—A teletypewriter connected to a line between, and in series with, other teletypewriter stations.

Wire communication—Communication by telephone, telegraph, teletypewriter, or any other means of communication employing a metallic circuit between the transmitting and receiving equipments.

Wire gage—System of numerical designations of wire sizes (low numbers designate the larger size).

Wire head—This is similar to a construction center. Construction personnel and test equipment, however, are not located at this point.

Wire net—Telephone communication system.

Wire pike—A 9-foot pole with hook and roller attached to one end which is used to simplify the laying and recovery of field wire.

Zero board—A switchboard installed at a construction center and used as a test board.

INDEX

	Paragraph	Page
Aerial construction.....	52a, 67	90, 107
Aircraft (wire laying).....	55	94
An/GGC-3, Teletypewriter set.....	99	149
AN/PGC-1, Teletypewriter set.....	98	148
Arctic areas, line construction.....	75	119
Assembly. (See cable assembly.)		
Axle RL-27-D.....	31	57
Basket hitch tie.....	19	32
Bridging connector.....	11	21
Cable assemblies, CX-1065/G and CX-1606/G.....	25	40
Care of climbers.....	37d, 39b	69
Care of leather.....	40b	72
CE-11 Reel equipment.....	33	62
Circuit:		
Designation.....	56	94
Diagram, tactical.....	61	100
Patching.....	84c	130
Tagging.....	57	95
Troubles.....	78, 82	122, 127
Clearances in overhead lines.....	65c	105
Climbers:		
LC-240/U.....	37	67
LC-241/U.....	38	69
Modified type.....	39	69
Clove hitch tie.....	14	24
Coil C-161 (repeating).....	113	167
Combination splice.....	9	18
Communication responsibility.....	4	4
Communication systems, field-wire.....	3	3
Connecting field wire to open-wires lines.....	11	21

	Paragraph	Page ^c
Construction, field-wire:		
Aerial (overhead)	52 <i>a</i> , 67	90, 107
Arctic areas	75	119
Centers	54	92
Desert areas	76	120
Lance pole	68	109
Long span	72	117
Orders and records	58	96
Preparation	63	102
Railroad crossings	66	106
River crossings	69	113
Road crossings	65	104
Surface lines	64	102
Teams	59	98
Techniques	63-72	102
Test stations	70 <i>b</i>	114
Tropical areas	77	120
Crosses (wire trouble)	79, 80	122, 124
Desert area construction	76	120
Designation of lines and circuits	56	94
Dispenser MX-306A/G, wire	30	53
Drip loops	13	24
EE-8-(), Telephone	89	136
EE-89-(), Telephone repeater	102	153
Electrical filter assembly F-98/U	107	158
Equipment trouble	82 <i>c</i>	129
Expedient field splice for spiral-four cable	26	45
Field cables	23-26	39
Field splicing spiral-four	26	45
Field wire (Wire WD-1/TT):		
Construction	63-72	102
Dispenser MX-306A/G, wire	28 <i>e</i> , 30, 72	53, 117
Maintenance	8-4	122
Reels	28	52
Servicing	71	115
Splicing	7-11	6
Systems	3	3
Tagging	57	95

Field wire—Continued	Paragraph	Page
Technical characteristics.....	6	5
Ties.....	12-22	23
Troubles.....	79, 80	122, 124
Filter assembly F-98/U, electrical.....	107	158
Gaff gage.....	39 <i>b</i>	69
Ground loop knot tie.....	15 <i>b</i>	28
Grounds (circuit trouble).....	79, 80	122, 124
Knob tie.....	17	29
Lance-pole construction.....	68	109
Lateral communication.....	4	4
LC-240/U, Climber.....	37	67
LC-241/U, Climber.....	38	69
Leather care.....	40 <i>b</i>	72
Line:		
Designation.....	56	94
Route map.....	60	98
Lineman's belt.....	40	72
Loading coil. (<i>See</i> Telephone loading coil assembly CU-260/G.)		
Locating and clearing trouble.....	82	127
Long-span construction.....	72	117
Loop knot tie.....	15	24
Maintenance kit MX-842/GT.....	110	162
Manual telephone switchboards.....	93, 96	140
Marline tie.....	18	29
MC-123, Wire pike.....	35	65
Modified climbers.....	39	69
Mountain area construction.....	75	118
Multimeter TS-297/U.....	116	178
MX-306A/G, Wire dispenser.....	28 <i>e</i> , 30	53
Open circuits.....	79, 80	122, 124
Orders required in construction.....	58	96
Overhead:		
Line clearance.....	65 <i>c</i>	105
Line construction.....	67	107
Loop knot tie.....	15 <i>a</i>	24

	Paragraph	Page
Packboard, method of laying field wire.....	29	53
Patching circuits.....	84 <i>c</i>	130
Patrolling wire lines.....	82 <i>d</i>	127
Phantom circuits.....	112-114	165
Pole climbing:		
Ascending.....	44	78
Descending.....	48	88
Equipment.....	36-40	67
Fastening safety strap.....	45	79
Preliminary instructions.....	43	78
Safeguards.....	42	77
Unfastening safety strap.....	47	87
Working on poles.....	46	84
Precautions when wearing climbers.....	41 <i>c</i>	74
Preparations required when laying field wire.....	63	102
Railroad crossing, field wire construction..	66	106
Records.....	83, 124	130, 186
Reels, field-wire.....	28	52
Removal of test stations.....	70 <i>c</i>	114
Removing insulation from field wire.....	8 <i>c</i>	9
Repeating coil:		
Characteristics.....	112	165
Coil C-161.....	113	167
TA-145/GT, Telephone repeating coil assembly.....	114	169
Resistance bridge ZM-4 ()/U.....	117	179
Responsibility for communication.....	4	4
River crossings, field-wire construction....	69	113
RL-26, Reel unit.....	34	64
RL-27-D, Axle.....	31	57
RL-31-E, Reel unit.....	32	59
Road crossings, field-wire construction....	65	104
Routine tests.....	81 <i>b</i>	125
Rubber cables. (See Field cables.)		
Safeguards:		
Pole climbing.....	42	77
Tree climbing.....	49	88

	Paragraph	Page
Safety strap.....	40a	72
Sag, line.....	19d, 67b	33, 107
Security.....	62	100
Seizing wire.....	7a, 8a	6, 7
Selection of line routes.....	53	91
Servicing field wire.....	71	115
Short circuit (wire trouble).....	79, 80	122, 124
Simplex circuits.....	112-114	165
Spiral-four cable.....	25, 26	40, 45
Expedient splice.....	26	45
Universal connectors.....	25c	40
Splicing:		
Combination.....	9	18
Standard field wire.....	8	7
Standard wire to bare solid-conductor wire.....	11	21
T-splicing.....	10	19
Square knot and loop tie.....	16	28
Surface line construction.....	52b, 54	90, 102
Switchboard:		
Characteristics.....	93	140
Operation.....	120-122	183
Records.....	124	186
SB-18/GT, Emergency.....	94	142
SB-22/GT, Manual telephone.....	95	144
SB-86/P, Manual telephone.....	96	145
TA-1()/TT, Telephone.....	90	137
TA-43/PT, Telephone set.....	88	135
TA-125/GT, Terminal box.....	109	162
TA-126/GT, Telephone repeater.....	101	151
TA-145/GT, Telephone repeating coil as- sembly.....	114	169
TA-264/PT, Telephone set.....	92	140
Tactical circuit diagram.....	61	100
Tagging field-wire lines.....	57	95
Taping a splice.....	8f, 11	13, 21
Teams, construction.....	59	98
Technical characteristics of wire WD-1/ TT.....	6	5

	Paragraph	Page
Telegraph-telephone terminal AN/TCC-14:		
Components.....	104-107	156
System application.....	108	159
Telegraph terminal TH-5/TG.....	105	156
Telephone:		
Cable, WF-8/G (spiral-four).....	25	40
Cable assembly CX-1512/U.....	25	40
Loading coil assembly CU-260/G.....	25 <i>g</i>	44
Repeaters.....	100-103	151
Repeating coil assembly TA-145/GT.....	114	169
Switchboards.....	93-96	140
Traffic diagram.....	123	183
Types.....	87-92	133
Teletypewriters:		
AN/GGC-3, set.....	99	149
AN/PGC-1, set.....	98	148
Characteristics.....	97	147
Tension bridge (spiral-four cable splice).....	26 <i>e</i>	51
Terminal strip (box).....	109-111	162
Test equipment:		
Characteristics.....	115	174
Multimeter TS-297/U.....	116	178
Resistance bridge ZM-4()/U.....	117	179
TS-26()/TSM, Test set.....	119	181
TS-27B/TSM, Test set.....	118	180
Test station:		
Construction.....	70 <i>b</i>	114
Conversion.....	70 <i>d</i>	114
Purpose.....	84 <i>a</i>	130
Testing methods.....	81	125
Testing poles.....	42	77
Ties, field-wire:		
Basket hitch.....	19	32
Clove hitch.....	14	24
Connecting field wire to open wire.....	22	37
Drip loop.....	13	24
Knob.....	17	29
Loop knot.....	15	24
Marline.....	18	29

Ties, field-wire—Continued	Paragraph	Page
Square knot and loop.....	16	28
Variation of basket hitch.....	20	34
Weave.....	21	36
TM-184, Terminal strip.....	111	165
TP-3, Telephone.....	91	139
TP-9, Telephone.....	92	140
TP-14, Telephone repeater.....	103	155
Traffic diagrams, telephone and teletype- writer.....	123	183
Tree climbing.....	49, 50	88, 89
Tropical area construction.....	76	120
Trouble, line.....	79	122
T-splice.....	10	19
TT-4()/TG, Teletypewriter.....	98	148
Tying a square knot.....	8 <i>d</i>	9
Types of field-wire construction.....	52	90
Underground:		
Construction.....	52 <i>c</i>	91
Road crossings.....	65 <i>d</i>	104
Unit responsibility.....	4	4
Variation of basket hitch tie.....	20	34
Weave tie.....	21	36
Wire:		
Construction technique.....	63-72	102
Dispenser MX-306A/G.....	28 <i>e</i> , 30, 72	53, 117
Head.....	54	92
Laying and recovery equipment.....	27-35	52
Line troubles.....	79, 80	122, 124
WD-1/TT, characteristics.....	6	5
Zero board.....	54	92
ZM-4()/U, Resistance bridge.....	117	179

[AG 413.43 (14 MAR 56)]

By Order of *Wilber M. Brucker*, Secretary of the Army :

MAXWELL D. TAYLOR,
General, United States Army,
Chief of Staff.

Official :

JOHN A. KLEIN,
Major General, United States Army,
The Adjutant General.

DISTRIBUTION:

Active Army:

Tec Svc, DA (2)	Co (1)
except CSIGO	Gen & Br Svc Sch (5)
(10)	except SigC Sch (50)
USMA (20)	PMST (2)
Tec Svc Bd (1)	Gen Depots (1)
Hq CONARC (5)	Sig Sec, Gen Depots (2)
Army AA Comd (5)	Sig Depots (2)
OS Maj Comd (5)	Trans Terminal Comd (5)
OS Base Comd (3)	Army Terminals (2)
MDW (2)	OS Sup Agencies (2)
Armies (ZI) (10)	PG (1)
Corps (2)	Arsenals (1)
Div (2)	MAAG (2)
Brig (2)	Mil Msn (1)
Regt/Gp (2)	ARMA (1)
Bn (1)	

NG: State AG (6); units—same as Active Army except allowance is one copy per unit.

USAR: Same as Active Army except allowance is one copy per unit.

For explanation of abbreviations used, see SR 320-50-1.