

MHI
Copy 3

Sup. 200. h
FM 7-11 (20 Apr. 1965)

FM 7-11

DEPARTMENT OF THE ARMY FIELD MANUAL

RIFLE COMPANY, INFANTRY, AIRBORNE INFANTRY AND MECHANIZED INFANTRY

PR.
QUARTERMASTER LIBRARY
U. S. ARMY QUARTERMASTER SCHOOL
FORT LEE, VA.

RESERVED FOR HISTORICAL USE ONLY



HEADQUARTERS, DEPARTMENT OF THE ARMY
JANUARY 1962

RIFLE COMPANY, INFANTRY, AIRBORNE INFANTRY, AND MECHANIZED INFANTRY

	Paragraphs	Pages
CHAPTER 1. GENERAL		
Section I. Introduction.....	1-5	3
II. Organization and duties, rifle company, infantry, airborne infantry, and mechanized infantry battalions.....	6-9	5
III. Operations.....	10-15	13
IV. Intelligence.....	16-20	19
V. Communication.....	21-23	24
VI. Command aspects of patrolling.....	24-27	29
CHAPTER 2. ADMINISTRATIVE SUPPORT		
Section I. General.....	28, 29	31
II. Personnel management and administration.....	30, 31	31, 34
III. Combat supply.....	32-37	35
IV. Combat supply, airborne infantry rifle company.....	38-43	38
V. Miscellaneous logistical activities.....	44-46	41
CHAPTER 3. OFFENSE		
Section I. General.....	47-49	46
II. Preparation for the attack.....	50, 51	46, 49
III. Planning the attack.....	52-61	50
IV. Conduct of the attack.....	62-69	61
V. Employment of attached tanks.....	70-74	72
VI. Mechanized infantry rifle company in the attack.....	75-87	77
VII. Rifle company in a reserve role.....	88, 89	92
VIII. Night attack.....	90-100	93
IX. River crossings.....	101-105	104
X. Raids.....	106-108	112
XI. Antiguerrilla operations.....	109-113	116
XII. Infiltration.....	114-116	118
CHAPTER 4. DEFENSE		
Section I. General.....	117-125	121
II. Forward rifle company—planning the defense.....	126-134	129
III. Forward rifle company—organizing the defense.....	135-139	142
IV. Forward rifle company—conduct of the defense.....	140-143	148
V. Perimeter defense.....	144-146	152
VI. Reverse slope defense.....	147-149	154
VII. Defense of a river line.....	150-152	157
VIII. Rifle company in a reserve role.....	153-156	159
IX. Relief in place.....	157-160	161
CHAPTER 5. RETROGRADE OPERATIONS		
Section I. General.....	161-167	165
II. Night withdrawal.....	168-172	170
III. Daylight withdrawal.....	173-176	174
IV. Delaying actions.....	177-181	179

	Paragraphs	Page
CHAPTER 6. AIRBORNE OPERATIONS		
Section I. General.....	182-188	183
II. Joint airborne operations—general.....	189-194	185
III. Joint airborne operations—planning.....	195-199	188
IV. Joint airborne operations—conduct.....	200-206	194
V. Airmobile operations—general.....	207-209	198
VI. Airmobile operations—planning.....	210-214	199
VII. Airmobile operations—conduct.....	215-219	207
VIII. Withdrawal by air.....	220-225	210
CHAPTER 7. TACTICAL MOVEMENTS		
Section I. Introduction.....	226-231	216
II. Tactical foot marches.....	232-238	217
III. Tactical motorized or mechanized movements.....	239-243	224
APPENDIX I. REFERENCES		228
II. TROOP LEADING PROCEDURES.....		231
III. OPERATION ORDERS.....		234
IV. EMPLOYMENT OF COMPANY GROUND SURVEILLANCE SECTION.....		237
V. EMPLOYMENT OF ARMORED PERSONNEL CARRIERS IN HASTY RIVER CROSSING OPERATIONS.....		250
VI. STANDARD PROCEDURES FOR PROTECTION AGAINST TOXIC CHEMICAL AT- TACK.....		258
INDEX		259

CHAPTER 1

GENERAL

Section I. INTRODUCTION

1. Purpose and Scope

a. This manual provides guidance on the tactical employment of the rifle company, infantry, airborne infantry, and mechanized infantry battalions.

b. The tactics, techniques, and procedures described herein are not inflexible rules, but are guides which commanders should modify as the varying conditions of the battlefield require.

c. The material contained herein is applicable to nuclear, non-active nuclear, and nonnuclear warfare.

d. With few exceptions, the material in this manual applies equally to all three types of rifle companies. Minor organizational and equipment differences do not affect the basic guidance. The parts of this manual that pertain exclusively to one type of rifle company are so specified.

e. Users of this manual are encouraged to submit recommended changes or comments to improve this manual. Comments should be keyed to the specific page, paragraph, and line of the text in which the change is recommended. Reasons should be provided for each comment to insure understanding and complete evaluation. Comments should be forwarded direct to the United States Army Infantry School, Fort Benning, Ga.

2. Leadership and Command

a. The company commander must realize that his unit is as good as the men who form it; and the success his company enjoys, whether it be in training or in combat, is the result of the concerted effort of all personnel of the company. Although this manual is devoted to the tactical employment of the rifle company it should be understood that the doctrine and principles established herein are only as effective as the men who employ them. In the final analysis, the degree of success achieved by a unit is directly related to the leadership displayed by its commander.

b. There is a difference between command and leadership. Command is the authority the company commander lawfully exercises over individuals in his unit by virtue of his assignment. Leadership is the art of influencing and directing men in such a way as to obtain their willing obedience, confidence, respect, and loyal cooperation in order to accomplish the mission. Not all

leaders will be commanders, but all commanders must be leaders ; for in a sense, leadership is the proper exercise of command. The company commander who commands only with his authority will never realize the full potential of his company. To realize this potential, the company commander exercises the responsibility and authority vested in him when he is given command of his unit and at the same time applies the principles of leadership in creating a proficient, well disciplined company possessing high morale and *esprit de corps*.

c. Everything a unit does in combat is directed toward the accomplishment of the mission. The company commander must not become so involved in planning as to subordinate his actions in the execution of the plan. A poor plan well executed has a better chance for success than a good plan poorly executed. In supervising the execution of his plans the company commander should be guided by the principles of leadership.

d. There will be occasions in combat when the accomplishment of the unit's mission will depend on the personal example set by the company commander. The histories of past wars in which the Army has fought are replete with situations where individuals, by their example, have turned failure into success and defeat into victory. This is not to imply that the company commander must lead the assault on every objective or be the last man to withdraw in a delaying action. The company commander should position himself where he can best control or influence the action, but at the same time he must be prepared to lead the action by a "follow-me" example if this is required to accomplish the mission.

3. Mission

The mission of the rifle company is to close with the enemy by means of fire and maneuver in order to destroy or capture him or to repel his assault by fire, close combat, and counterattack.

4. Capabilities

The rifle company is capable of—

a. Closing with the enemy by means of fire and maneuver in order to destroy or capture him.

b. Repelling enemy assault by fire, close combat, and counterattack.

c. Providing a base of fire and maneuver elements.

d. Seizing and holding terrain.

e. Maneuvering in all types of terrain and climatic conditions.

f. Capitalizing on all forms of mobility.

g. Conducting parachute assaults when organic to the airborne infantry battalion.

5. Characteristics

a. Infantry is the arm of close combat. It fights by combining fire, maneuver, and shock action. It is capable of seizing and holding terrain for extended periods. Because of its versatility, it is capable of fighting under widely varying conditions of terrain, weather, and nuclear availability. The organization, equipment, and training of infantry units permit their use of a variety of techniques to accomplish their mission.

b. The rifle company is the basic tactical element of the battalion. Its organization and equipment provide it with the necessary means to conduct combat operations. When increased combat power is required for specific tasks, the company is capable of receiving and controlling additional combat and combat support elements. When suitably reinforced, the rifle company is capable of independent operations for limited periods. While the mobility of the rifle company, infantry, and airborne infantry battalion, is that of the dismounted soldier, the company can adapt to other forms of mobility with the provision of armored personnel carriers (APC), trucks, and aircraft. The rifle company, infantry, and airborne infantry battalion, is completely air transportable in helicopters, medium assault aircraft, or medium transport aircraft. The rifle company, mechanized infantry battalion is completely mobile. It is air transportable in helicopters, medium assault aircraft, or medium transport aircraft less its heavier equipment.

Section II. ORGANIZATION AND DUTIES, RIFLE COMPANY, INFANTRY, AIRBORNE INFANTRY, AND MECHANIZED INFANTRY BATTALIONS

6. Organization

a. *General.* The rifle company consists of a company headquarters, three rifle platoons, and a weapons platoon (fig. 1).

b. *Company Headquarters.*

- (1) Personnel of company headquarters infantry, and airborne infantry rifle companies, include those who command or directly assist the commander, and those who provide administrative support. The former normally includes the company commander, executive officer, first sergeant, communication chief, radiotelephone operators, wiremen, and ground surveillance personnel. The latter normally includes the supply sergeant, armorer, and company clerk. One of the 1/4-ton trucks with trailer organic to company headquarters, carries one of the company's vehicle-mounted radios and is normally used as the company commander's command and reconnaissance vehicle. Another 1/4-ton truck with trailer in

company headquarters carries the other vehicular radio and is used to carry communication equipment. A 2½-ton truck is assigned to carry ammunition, equipment, and baggage. The ground surveillance section is equipped with two ¼-ton trucks with trailers.

- (2) The company headquarters of the mechanized infantry rifle company differs in that—
 - (a) One APC is used as a CP vehicle.
 - (b) A maintenance section, consisting of eleven men, is part of the company headquarters.
 - (c) One ¾-ton truck with trailer, one APC, and one medium tank recovery vehicle are in the maintenance section.
 - (d) There is only one ¼-ton trailer in the company headquarters.

c. Rifle Platoon.

- (1) The rifle platoon of the infantry and airborne infantry rifle companies consists of a platoon headquarters, three rifle squads, and a weapons squad. The platoon headquarters consists of the platoon leader, platoon sergeant, and a radio telephone operator. Each rifle squad consists of a squad leader and two fire teams which are designated ALFA and BRAVO. Each fire team has a fire team leader, an automatic rifleman, a grenadier, and either one or two riflemen. The weapons squad has a squad leader, two machinegunners, two assistant machinegunners, two rocket gunners, two assistant rocket gunners, and two ammunition bearers.
- (2) The rifle platoon of the mechanized rifle company is generally the same, however, there is only one ammunition bearer, and one APC driver in the weapons squad. Each squad is equipped with an APC.

d. Weapons Platoon.

- (1) The weapons platoon of the infantry and airborne infantry rifle companies consists of a platoon headquarters, an 81-mm mortar section, and an antitank section. In the platoon headquarters are the platoon leader, platoon sergeant, and a radiotelephone operator. The 81-mm mortar section headquarters consists of a section leader, three forward observers, two fire direction computers, and three radiotelephone operators. Each of the three 81-mm mortar squads has a squad leader, gunner, assistant gunner, and two ammunition bearers. The antitank section headquarters consists of a section leader. Each of the two antitank squads has a squad leader,

gunner, assistant gunner and two ammunition bearers. The platoon's organic transportation is as follows: one 1/4-ton truck with trailer in platoon headquarters, one 3/4-ton truck with trailer in the 81-mm mortar section headquarters, one 3/4-ton truck with trailer in each 81-mm mortar squad, and one 1/4-ton truck (for the AT weapon) and one 3/4-ton truck with trailer in each anti-tank squad.

- (2) The weapons platoon of the mechanized infantry rifle company differs in that the four 3/4-ton trucks in the mortar section are replaced by one APC and three mortar carriers, full tracked. There are two radio telephone operators and one APC driver (who is also a radiotelephone operator) in the mortar section headquarters. Each mortar squad has only one ammunition bearer, and one APC driver who is also a radiotelephone operator.

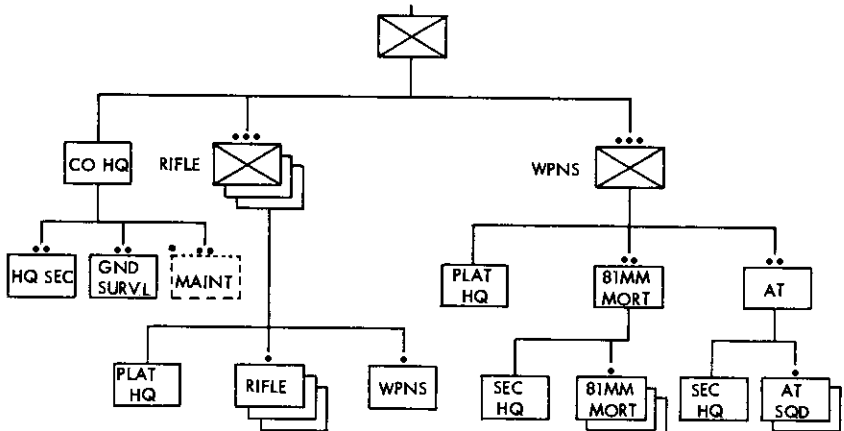

*For mechanized rifle company only

Figure 1. Rifle company.

7. Duties of Company Headquarters Personnel

a. Company Commander.

- (1) The company commander alone is responsible for what his company does or fails to do. He is responsible for the training, maintenance, discipline, control, tactical employment, administration, and welfare of his company and for all aspects of its performance in garrison and in combat.
- (2) The company commander controls the company and is responsible for its operation. He meets his responsibilities by planning, by timely decisions and orders and by per-

sonal supervision. His professional knowledge must include a thorough understanding of the tactical employment of the rifle company, the technical capabilities and limitations of organic weapons, and the use, capabilities, and limitations of other arms and services that may be associated with the company in combat.

- (3) The company commander exercises command through his platoon leaders and first sergeant. Within guidance set forth by higher headquarters, he establishes policies and standards for the company. By formal and informal inspections he insures that his policies and standards are executed or attained properly. He insures that all personnel of the company have access to him in the discussion of personal or other matters.
- (4) The company commander trains his subordinate leaders and uses them to the maximum in accomplishing his mission. He supervises the performance of those under his command and takes positive action to correct any deficiencies. He strives to develop in his subordinate leaders such qualities as initiative, self-reliance, ingenuity, and professional competence by furnishing guidance and then allowing them maximum freedom of action in performing their assigned tasks.
- (5) In combat, the company commander makes decisions on the tactical employment of his unit based on orders from higher headquarters and on his estimate of the situation. He keeps informed of the situation at all times. He goes where he can best influence the action of his company. When a situation exists which is beyond the capability of his unit to cope with, he requests assistance from higher headquarters. In the absence of orders, as when he is unable to communicate with higher headquarters, he makes decisions for the employment of the company based on his understanding of the overall mission and on his estimate of the situation.
- (6) The company commander is responsible for the combat effectiveness of his unit and the personal well-being of the individuals under his command. Combat effectiveness is developed by producing sound plans and orders; by achieving adequate supervision of the execution of orders and training; by fostering *esprit de corps* and a high state of morale; by making effective use of available personnel and supplies; by keeping personnel in good physical condition, and by achieving a high quality of leadership. Personal well-being of individuals is de-

veloped by fostering good mental attitudes; by considering and aiding their physical comfort; by fostering a high state of morale; by giving them the opportunity to acquire a sense of accomplishment; and by promoting a sense of security. The company commander by his personal actions and by directing and supervising his subordinate leaders insures that a continuous and effective effort is made to attain the highest possible standard in these matters.

b. Executive Officer. The executive officer performs duties assigned to him by the company commander. He keeps abreast of the tactical situation and assumes command of the company in the absence of the company commander. He is in charge of the operations of the command post and insures communication with elements of the company, battalion, adjacent companies, and supporting units. He notifies appropriate units of changes in the command post's location. He controls the movement of administrative vehicles within the company area and supervises the supply of ammunition to the platoons. He supervises company administration, supply, and service, to include the company aid post. In the mechanized infantry rifle company he is also the company motor officer.

c. First Sergeant. The first sergeant assists the company commander by performing assigned duties including the supervision of training, administration, mess, supply, and maintenance activities. He makes recommendations to the company commander on such items as appointments, reductions, assignments, and disciplinary matters as they pertain to the enlisted members of the company. He assists the executive officer and represents him when he is temporarily absent from the command post.

d. Communication Chief. The communication chief supervises the installation and operation of the company communication system and assists in procuring signal supplies. He coordinates with the maintenance section leader on matters concerning organizational signal maintenance. He advises the company commander on matters pertaining to communication security, and he disseminates appropriate information from current communication orders (SOI extracts and SSI). He supervises the radiotelephone operators and wiremen in the performance of their communication duties. He conducts communication training as directed by the company commander.

e. Radiotelephone Operators. The two radiotelephone operators operate the radios of company headquarters and perform first echelon maintenance on the company's radio equipment. They are trained to operate all of the company's communication equipment. The radiotelephone operators are also light truck drivers. In the

mechanized infantry rifle company, the APC driver is also a radiotelephone operator.

f. Wiremen. The two wiremen install and maintain the company wire system, assisted by other personnel as necessary. They are trained to operate all of the company's communication equipment. There are no wiremen in the mechanized infantry rifle company.

g. Supply Sergeant. The supply sergeant requests, receives, issues, stores, maintains, and turns in supplies and equipment for the company in accordance with current regulations and policies. Under the supervision of the company commander or his designated representative, he prepares and maintains required supply records.

h. Armorer. The armorer performs second echelon maintenance on the weapons of the company. In the infantry and airborne infantry rifle company, the armorer is supervised by and assists the supply sergeant. In the mechanized infantry rifle company, he is assigned to the maintenance section and is supervised by the maintenance section leader.

i. Company Clerk. The company clerk performs necessary clerical duties under the supervision of the first sergeant. He also delivers incoming mail and collects and processes outgoing mail.

j. Ground Surveillance Personnel. The section leader is responsible for the section's training, control, tactical employment, and supply. He recommends to the company commander methods of employment of the section. The senior radar operators are responsible for establishing and operating a radar site(s) and for preparing appropriate radar surveillance cards. The radar operators assist the senior radar operators as directed, they operate the radios and drive the sections' two $\frac{1}{4}$ -ton trucks. For employment of ground surveillance section, see appendix IV.

k. Maintenance Section Personnel (Mechanized Infantry Rifle Company). The maintenance section is composed of a motor sergeant (section leader), tracked vehicle mechanics, recovery mechanics, two radio mechanics, and an armorer. Vehicles authorized are one APC, one medium tank recovery vehicle, and one $\frac{3}{4}$ -ton truck with trailer. The company maintenance section has the primary function of keeping all company vehicles, armament, and communication equipment operating at maximum efficiency. Vehicles requiring more extensive repairs than the maintenance section can accomplish, are turned over to the battalion maintenance platoon. The motor sergeant supervises company organizational maintenance, is in charge of the company reserve of repair parts, and keeps records on all scheduled maintenance.

8. Duties of Rifle Platoon Personnel

a. Platoon Leader. The platoon leader commands his platoon and is responsible for the discipline, training, welfare, control, and tactical employment of his platoon. In addition, he is responsible for all equipment issued to his platoon.

b. Platoon Sergeant. The platoon sergeant assists in the control of the platoon and supervises ammunition resupply. He assumes command in the absence of the platoon leader.

c. Radiotelephone Operator. The radiotelephone operator operates the communication equipment located in platoon headquarters.

d. Rifle Squad Leader. The rifle squad leader is responsible for the discipline, training, welfare, control, and tactical employment of his squad. He uses his fire team leaders to assist him in control.

e. Fire Team Leader. The fire team leader assists the squad leader in control of the squad in combat, and directs the actions of his team in carrying out the squad leaders orders, or as required by the situation. The senior fire team leader assumes command of the squad in the absence of the squad leader.

f. Rifle Squad Members. Riflemen and automatic riflemen are trained to be proficient in individual as well as team combat action. Their specific tasks are specified by the squad leader or fire team leader, as appropriate. One rifleman in each fire team is normally designated to carry additional ammunition for the automatic rifleman. In addition, one member of each fire team is assigned as a grenadier and is equipped with the M79 grenade launcher.

g. Weapons Squad Leader. The weapons squad leader is responsible for the discipline, training, welfare, and the tactical employment of his squad. He normally selects exact firing positions for squad weapons and he may control their fires. He supervises the displacement of his squad.

h. Weapons Squad Members. The machinegunners and the rocket gunners employ their assigned weapons as directed by the weapons squad leader. They control the fire of their weapons and the displacement of their teams as directed. The senior gunner assumes command of the squad in the absence of the squad leader. Assistant gunners assist in the employment of their respective weapons. Ammunition bearers resupply ammunition for the machineguns and antitank weapons as directed and are prepared to replace members of either a machinegun or antitank weapon team in the event of casualties. In the mechanized infantry rifle company there is only one ammunition bearer in each squad. The APC driver is also an ammunition bearer.

i. APC Driver. In the mechanized infantry rifle platoon a member of each rifle squad is designated as driver of the APC. There is one APC driver in the weapons squad.

9. Duties of Weapons Platoon Personnel

a. Platoon Leader. The platoon leader commands his platoon and is responsible for the discipline, training, welfare, control, and tactical employment of his platoon. He normally makes recommendations to the company commander on the employment of elements of the platoon and assists him in fire support planning. In addition, he is responsible for all equipment issued to his platoon.

b. Platoon Sergeant. The platoon sergeant assists in the control of the platoon, supervises ammunition resupply, and supervises the use of the platoon's transportation. He assumes command of the platoon in the absence of the platoon leader.

c. Radiotelephone Operator. The radiotelephone operator operates the communication equipment located in platoon headquarters. He is also a light truck driver.

d. Antitank Section Leader. The antitank section leader is responsible for the discipline, training, welfare, and tactical employment of his section. He makes recommendations to the platoon leader on the tactical employment of the antitank squads, including location of firing positions, displacement, and targets. He supervises ammunition resupply.

e. Antitank Squad Leader. The antitank squad leader is responsible for the discipline, training, and control of his squad and, based on instructions from the section leader, for its tactical employment. Specifically, he selects exact firing positions for his squad, designates targets, and supervises displacement.

f. Mortar Section Leader. The 81-mm mortar section leader is responsible for the discipline, training, and control of his section and, based on instructions from the platoon leader, for its tactical employment. He selects firing positions for his squads, controls their fire and displacement, and supervises all the activities of his section, including ammunition resupply.

g. Forward Observers. The FO's observe and adjust the fire of the mortar squads and, when required, the fire of artillery and 4.2-inch mortar units.

h. Fire Direction Computers. The fire direction computers prepare the necessary firing data for the mortars.

i. Radiotelephone Operators. These men operate and maintain the communication equipment in the fire direction net. Normally one radiotelephone operator operates the platoon leaders' radio in the company command net, and the other three radiotelephone

operators operate radios in the fire direction net. In addition, they perform first echelon maintenance on the platoon's radio equipment. Two radiotelephone operators are also light truck drivers. In the weapons platoon, mechanized infantry rifle company the APC driver is also a radiotelephone operator.

j. 81-mm Mortar Squad Personnel. The mortar squad leader is responsible for the discipline, training, and control of his squad and, based on instructions from the section leader, for its tactical employment. Specifically, he selects exact firing positions for his squad, controls its fire, and supervises displacement. One of the ammunition bearers is also a light truck driver. In the mechanized infantry rifle company there is only one ammunition bearer in each squad. For additional discussion of the duties of squad members, see FM 23-90.

k. APC Driver. In the mechanized infantry rifle company there is one APC driver in the mortar section headquarters and one APC driver in each mortar squad. These APC drivers are also radiotelephone operators.

Section III. OPERATIONS

10. Tactical Employment

a. The rifle company normally fights as part of the battalion. It may be attached to other elements of the division for a particular operation, and it may operate for limited periods as a semi-independent force.

b. When operating as part of the battalion or when attached to another unit, the company operates under the direct control of the battalion commander or the commander of the unit to which it is attached. When it operates as an independent or semi-independent force, the company commander normally receives a mission-type order and conducts the operation with little or no supervision by higher authority.

c. The rifle company must be trained to accomplish assigned missions under any condition of warfare and variations in terrain and weather. In general, there are three conditions of warfare in which the rifle company may participate: nuclear war, nonactive nuclear war (threat only exists) and nonnuclear war (no threat exists).

d. For additional discussion of general considerations for nuclear and nonnuclear warfare, see FM 7-20. For a detailed discussion of individual and unit protective measures and associated training, see FM's 21-40, 21-41, and 21-48.

11. CBR Operations

CBR operations are characterized by wide area coverage with toxic chemical agents, biological agents, and radioactive materials. Proper training will reduce the probability of mass casualties. Commanders will appoint a CBR NCO on an additional duty status. Commanders are responsible for the readiness of their units to operate under conditions of CBR operations with maximum individual and unit effectiveness. CBR survey teams are trained in the operation of Radiological Survey Meters and Chemical Agent Detector Kits. Standard procedures for protection against toxic chemical attack are outlined in appendix VI. Additional discussion of CBR operations is contained in FM's 3-5, 21-40, and 21-41, AR 220-58, and TC 101-1.

12. Security

a. Security measures are aimed at protecting a unit by preventing surprise and giving the unit time to prepare to counter an enemy threat. They include the steps taken to prevent being surprised by ground, airborne, and air attacks; to provide early warning of chemical, biological, and radiological attack or contamination; and to protect supplies and supply installations. All commanders and leaders are responsible for the security of their units at all times, regardless of the measures taken by higher commanders.

b. Specific security measures may include the use of observation and listening posts, aerial observers in Army aircraft, patrols and security detachments (dismounted, mounted, and airmobile), warning devices, surveillance devices, and instruments to detect radioactivity and chemical agent contamination. Proper unit formations and dispositions contribute to security. For a discussion of security measures appropriate to CBR operations, see FM 21-40. Security measures appropriate for various tactical operations are discussed throughout this text.

13. Action Against Enemy Aircraft

The rifle company and its elements take passive measures to prevent detection by enemy aircraft and to minimize the effects of an enemy air attack. Such measures include dispersion, the use of concealment and cover, camouflage, and the establishment of an adequate warning system. Under an air attack, all available small arms fire is delivered on the attacking aircraft. Positively identified low-flying aircraft may be taken under fire when the unit is not under direct attack, if limitations on firing at low flying aircraft have not been imposed by the battalion commander. The company may use a technique known as "pattern of fire." This technique involves every individual aiming his individual or crew-

served small arms weapon directly into the air overhead. On signal, individuals commence firing and in this manner the enemy aircraft flies into the fire and no attempt is made to track the aircraft. Leaders must exercise control in the use of this technique to insure that ammunition is not wasted through indiscriminate firing.

14. Estimate of the Situation

a. When a unit is assigned a mission, the commander or leader must determine the best way to accomplish it. Since there is always more than one way to accomplish any mission, there must be a systematic method of selecting the course of action which offers the greatest possibility of success. The problem-solving process used to arrive at this decision is called the estimate of the situation. Estimating the situation is a continuing process. After making his initial estimate, the commander reviews it with each change in the situation to determine if he should continue his current course of action or if he should adopt a new course. He may make his estimate quickly or deliberately, depending primarily on the time available. In either event, he can reach a sound decision only if he considers all the facts bearing on the accomplishment of the mission. The sequence of the elements of the estimate listed below provides for the logical and orderly examination of all the facts, and it serves as a mental checklist to insure that nothing is overlooked. The commander should follow this sequence, no matter how quickly he makes his estimate.

- (1) Mission.
- (2) The situation and courses of action.
 - (a) Weather; terrain; enemy situation; friendly situation.
 - (b) Enemy capabilities.
 - (c) Own courses of action.
- (3) Analysis of opposing courses of action.
- (4) Comparison of own courses of action.
- (5) Decision.

b. Discussion of steps in the estimate of the situation :

- (1) *Mission.* A thorough understanding of the task to be performed is essential. If there is any question about the assigned mission, additional information must be obtained from the commander who assigned it. Throughout the conduct of the operation, the commander must keep the mission foremost in mind. Situations arise which might divert him unless he continually reviews the assigned task.
- (2) *The situation and courses of action.* The purpose of this step is to consider all the factors which affect the employ-

ment of the unit, the capabilities of the enemy that could threaten the accomplishment of the mission, and the reasonable courses of action which, if successful, will accomplish the mission.

- (a) The weather is considered as it will affect personnel, equipment, and visibility and trafficability within the area of operations.
 - (b) A thorough terrain analysis is made of the area of operations. The terrain is studied both from the friendly and enemy viewpoint to evaluate observation and fields of fire, concealment and cover, obstacles, key terrain, and avenues of approach. The commander considers how these aspects of the terrain will affect the mission.
 - (c) The enemy and friendly situations are studied to determine the relative strengths and weaknesses of each. Such factors as the dispositions, reinforcements available, weapons, fire support available, morale, status of supply, and recent significant activities are considered.
 - (d) Enemy capabilities are all courses of action of which the enemy is physically capable and which, if adopted, will affect accomplishment of the mission.
 - (e) The commander lists in his mind all the feasible courses of action that are open to him to perform the assigned task. He does not make a decision at this point.
- (3) *Analysis of opposing courses of action.* Having determined the possible courses of action, the commander considers how each of these would be affected by each of the enemy's capabilities. In this analysis, the commander visualizes the probable outcome of each course of action when opposed by each enemy capability. During this analysis, the other factors such as weather, terrain, enemy situation, and friendly situation, are also considered as they affect the courses of action. Certain of these factors may have the same effect on each course of action. Other factors, called the governing factors, have a different influence on the several possible courses of action, and it is these governing factors which are the basis for the comparison of own courses of action.
- (4) *Comparison of own courses of action.* The governing factors are usually the terrain, enemy dispositions, friendly dispositions, and enemy capabilities. On occasion, time may also be a governing factor. The commander compares the various courses of action in light of the governing factors and weighs the advantages

and disadvantages of each. Based on his military knowledge, experience, and his sound judgment, he selects the course of action which offers the best chance of success. If two or more courses of action offer equal promise, he selects the one which most favors future action.

- (5) *Decision*. The course of action selected is translated into a concise statement of what the unit will do. It includes answers to the questions WHO?, WHAT?, WHEN?, WHERE?, HOW?, and WHY?

c. After analyzing the assigned mission, the commander habitually makes an estimate of the situation. As a mental checklist, to insure consideration of essential elements required in arriving at a course(s) of action to be analyzed in the estimate, the commander habitually considers the mission, enemy, terrain and weather, and troops and fire support available (METT).

- (1) *Mission* (b(1) above).
- (2) *Enemy* (b(2)(c) above).
- (3) *Terrain and weather* (b(2)(a) and (b) above).
- (4) *Troops and fire support available*. This term refers to all combat power available to the company, to include maneuver elements, fire support, mobility means, logistical support, and attached and supporting elements. The disposition of the company and adjacent units, and time and space factors must be taken into consideration.

15. Organization for Combat

a. *Definition*. Organization for combat is the temporary organization for conducting a specific operation. At company level it entails the temporary assignment of units or personnel to subordinate elements of the company. For example, 81-mm forward observers from the weapons platoon must be assigned to rifle platoons as appropriate. Similarly, aidmen from the battalion medical platoon are assigned. In certain situations, tanks or antitank squads may be attached to rifle platoons.

b. *Battalion Task Forces*. Tank battalions and infantry battalions normally operate attached to brigades. The brigade commander may employ the attached battalions as pure battalions (all elements from a single arm), or he may organize them for combat by cross-attachment. Similarly, tank and rifle companies normally operate directly under control of one of the battalions. The battalion commander may employ his companies as pure companies or he may organize them for combat by cross-attachment. When this cross-attachment occurs at battalion level, a battalion task force results. A battalion task force is a temporary grouping of units, formed to provide the battalion task force commander

with the number and type of units necessary to accomplish a specific mission or task. A battalion task force may be organized around an infantry battalion headquarters or a tank battalion headquarters. A battalion task force is considered balanced when it contains infantry companies and tank companies in equal number. The task force is infantry heavy when it contains more

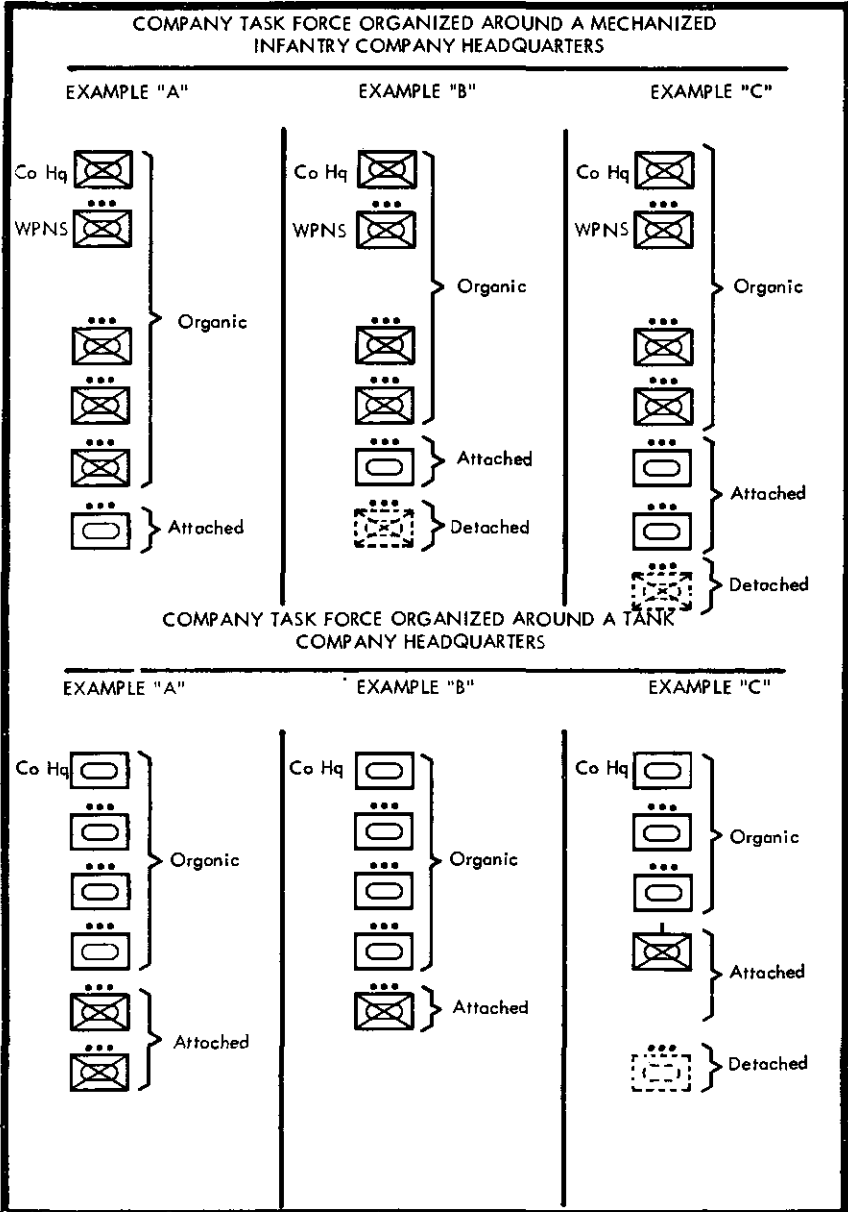

Figure 2. Examples of company task forces.

infantry companies; and it is tank heavy when it contains more tank companies. See also FM 7-20.

c. Company Task Forces.

- (1) A company task force is a tactical grouping of units under one company commander formed for a specific operation or mission. The company task force normally consists of a complete company with one or more non-organic units attached, or a company minus one or more organic units with one or more nonorganic units attached.
- (2) Within the battalion task force, the commander organizes company task forces (fig. 2). The ratio of tank to infantry units in a company task force varies with the consideration of METT. Tank and infantry units are usually employed together; if they are not together, they should be within supporting distance of each other.
- (3) Platoons normally are employed as a part of the company task force. Typical exceptions would be patrol, reconnaissance, or direct fire support missions. The platoon usually is the smallest maneuver element to be attached to another organization. Tanks should not be attached by sections unless terrain or other conditions prevent the effective operation of a complete platoon.

d. Command of Company Task Forces. In forming task forces, the commander of the unit to whom the attachment is made commands the attached unit. Normally, an infantry heavy battalion or company task force is commanded by the infantry commander while a tank-heavy task force is commanded by a tank unit commander. Within company task forces, the infantry platoon and tank platoons are commanded directly by the TF commander. As a general rule, a platoon leader will not command any platoon other than his own. Coordinated action between platoons of a company task force is attained by orders to each platoon leader from the TF commander and by cooperation between platoons. If it is necessary to place two platoons under a single commander, the company executive officer may be used to command them.

Section IV. INTELLIGENCE

16. General

a. Combat intelligence is essential to the development of sound plans by commanders at all echelons. The purpose of the intelligence effort is to discover facts and draw appropriate conclusions from them concerning the weather, terrain, and enemy that can be used to facilitate the accomplishment of the mission, and to deny the enemy information of friendly forces and terrain.

b. The rifle company is an information collection agency for higher headquarters. It is frequently given specific collection missions. The company promptly reports all information to battalion which disseminates it to higher, subordinate, and adjacent units as appropriate.

c. Intelligence produced by higher headquarters is furnished to the company commander who, in turn, passes it on to his subordinates.

d. Unit standing operating procedures normally prescribe special measures to expedite reporting of particularly vital information, such as indications of probable enemy use of nuclear and CBR weapons, to include fallout predictions.

e. For a more complete discussion of intelligence and intelligence training, see FM 30-5 and FM 30-7.

17. **Weathre**

a. The company commander normally receives daily weather forecasts through the battalion. He uses the forecasts to evaluate the effect the weather will have on his tactical operations.

b. The times of BMNT (beginning of morning nautical twilight) BMCT (beginning morning civil twilight), EECT (end evening civil twilight), EENT (end of evening nautical twilight), moonrise, moonset, and the phase of the moon, are important in determining visibility. At BMNT, enough light, under ideal conditions, is available for infantry to effect close coordination among individuals and to approach the enemy position relatively unobserved. EENT is the last period of the day where enough light exists for such coordination. As a general rule visibility at BMNT is about 400 meters. At about half way between BMNT and BMCT or (EECT and EENT), there is enough light for ground adjustment of close in artillery fires. Visibility is affected by such other conditions as cloud cover, fog, rain, snow, dust, and haze. Rain, snow, freeze, or thaw may affect troop movements, particularly by vehicle. Storms and extremes of temperature may adversely affect personnel and equipment.

18. **Terrain**

Terrain is one of the major factors considered in the commander's estimate of the situation. He studies the military aspects of terrain described below, to determine how he can best use the terrain to aid in accomplishing his mission.

a. *Observation and Fire.* Observation assists in gaining information of the enemy, in accurately directing fire on him, and in controlling troops. Fields of fire are essential for the effective employment of all available direct fire weapons. The commander

considers the available observation and fields of fire both from a friendly and enemy point of view.

b. Concealment and Cover. Concealment is protection from observation; cover is protection from fire. The commander determines the concealment and cover available to both his company and the enemy. He evaluates cover from the standpoint of protection from the effects of—flat trajectory fire, high angle fire, and nuclear weapons. An area such as woods may provide concealment from both air and ground observation, but little or no cover, especially from high explosive shells and nuclear weapons.

c. Obstacles. Obstacles are either natural or artificial terrain features which stop or impede military movement. Natural obstacles include such features as unfordable streams, swamps, very steep slopes, and lakes. Artificial obstacles include those created by nuclear or nonnuclear fires, minefields, flames field expedients, barbed wire entanglements, roadblocks, and antitank ditches. The commander considers the effect of obstacles on friendly and enemy movement of foot troops and wheeled and tracked vehicles.

d. Key Terrain. Any terrain feature whose seizure, retention, or control gives a marked advantage to either combatant is key terrain. Examples may include such features as a hill, ridge, bridge, defile, and built-up area. The company commander studies the key terrain features within and adjacent to his zone or area to determine their effect on the company's operation.

e. Avenues of Approach. An avenue of approach is terrain that provides a relatively easy route for a force of a particular size to reach an objective or key terrain feature. In the attack, the commander studies his area to determine available avenues of approach to the objective. He also determines the best avenues of approach that the enemy can use for counterattacks and resupply. In the defense, the commander studies his sector to determine avenues of approach available to the enemy leading to key terrain within or in rear of his sector. When analyzing avenues of approach, he considers the following:

- (1) A desirable avenue of approach provides observation and fire for the using unit, has concealment and cover from the defender's observation and fire, avoids obstacles, assists ease of movement, has sufficient maneuver space for the using unit, and utilizes key terrain.
- (2) Normally the company commander considers avenues of approach that will accommodate a platoon size force.
- (3) Cross compartments and corridors. A terrain compartment is an area bounded on two opposite sides by terrain features that limit ground observation and direct fire

into the area. Terrain compartments are classified as corridors or cross compartments, depending on the direction of movement of forces operating in them. A corridor is a terrain compartment whose long axis lies parallel to the direction of movement. A cross compartment is a terrain compartment whose long axis lies at a right angle to the direction of movement (fig. 3). A corridor generally favors the attacking unit. It provides two types of avenues of approach—a ridge approach and a valley approach. Using a ridge approach insures control of the dominant terrain, increases observation and fields of fire and, when the movement is along the slopes, often permits some concealment and cover to be obtained. A valley approach often provides the best concealment but reduces observation and the effectiveness of fire. The use of a valley approach is dangerous unless the high ground to the flanks is controlled. A cross compartment generally favors the defending force.

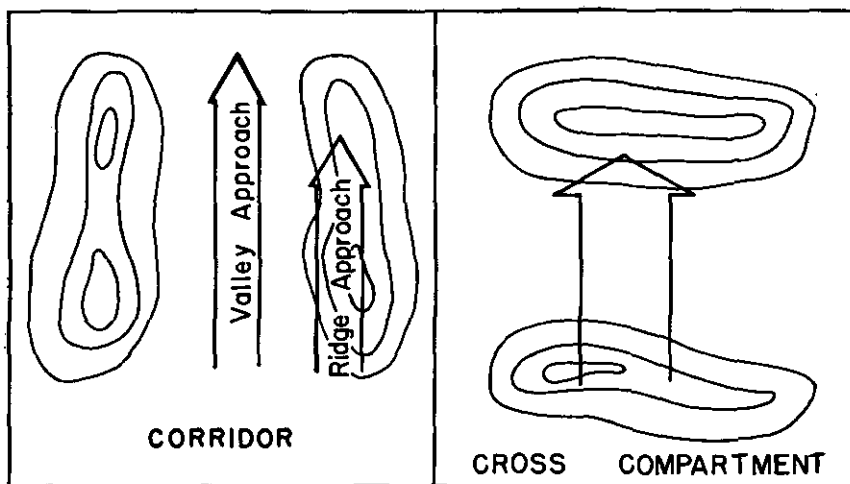

Figure 3. Terrain Compartments.

19. Enemy Information

a. Information is sought of the enemy *strength*, *location*, and *activity*. This information is evaluated to determine enemy capabilities and their probable order of adoption. Of particular interest at company level and below are such items of enemy information as the strength and location of opposing forces in contact; enemy activity; details of positions, including automatic weapons, mortars, tanks, and antitank weapons; location and strength of local reserves; and minefields, barbed wire, and other obstacles.

b. Forward forces stress the importance of collecting enemy information. Emphasis is placed on detecting and rapidly reporting enemy forces that are profitable targets so that nuclear or non-nuclear fires may be delivered before the forces can disperse. Units are particularly alert to detect and report any sudden enemy withdrawal, because it may indicate the enemy plans a nuclear attack.

c. The company obtains information of the enemy primarily through patrolling, observation, and the use of organic surveillance devices. Information is also obtained from higher headquarters and adjacent and supporting units. Since the enemy maintains a counterintelligence effort, the company must be aggressive in its efforts to obtain enemy information. When appropriate, the company commander requests assistance, such as aerial photography, reconnaissance, or surveillance from higher headquarters. The company is trained to report all information of the enemy, negative as well as positive. Often, the knowledge that the enemy is *not* at a certain location or *not* engaged in a certain activity is as important as knowing where he is and what he is doing.

d. Patrolling is normally coordinated by battalion and its SOP usually specifies the coordination required. Even though the battalion patrol plan requires the company to perform specific patrolling missions, this does not prevent the company from conducting additional patrols for its own purposes. These patrols must be coordinated with higher headquarters. (See also pars. 24-26.)

e. Prisoners of war may be interrogated briefly at company level if an interpreter is available, to obtain information of immediate tactical interest to the company. Such interrogation must not unduly delay the evacuation of prisoners to higher headquarters. Civilians are interrogated in accordance with the provisions of FM 27-10.

f. Items of technical intelligence interest, such as captured foreign materiel, equipment, methods, techniques, and the organizations employing them, are normally first encountered by combat troops. Such information or materiel collected by the rifle company is transmitted as expeditiously as possible through intelligence channels to higher headquarters for evaluation and exploitation. For a more complete discussion of technical intelligence, see FM 30-16.

20. Counterintelligence

a. Counterintelligence measures are taken to deny the enemy information of friendly forces, to expose and neutralize his intelligence effort, and to mislead him through deception. To be effective, counterintelligence measures must be understood and practiced by all personnel concerned.

b. At company level, emphasis is placed on denying the enemy information and neutralizing his intelligence effort. The company normally does not engage in deception except as directed by higher headquarters. Counterintelligence measures at company level and below include secrecy, discipline, censorship, communication security, counterreconnaissance, surveillance, and control of civilians. Specifically, the company commander is responsible for insuring that counterintelligence measures directed by higher headquarters are implemented and enforced and that—

- (1) All men are instructed on their behavior if captured. (FM 21-77).
- (2) Letters, personal papers, photographs, and other material that could provide the enemy information are collected from all personnel prior to an action.
- (3) Specific instructions are issued on safeguarding military information and equipment, including the destruction of documents and equipment of value to the enemy if capture is imminent.
- (4) Camouflage, concealment, and cover are properly used and that noise and light discipline are enforced.
- (5) The sign and countersign are properly used.
- (6) Bivouacs and assembly areas are policed to insure that no personal items, maps, documents, or other material of possible intelligence value are left behind. The enemy will open sumps therefore, if possible, sumps will be burned before closing.
- (7) Information on the friendly use of nuclear weapons is disseminated at the latest practicable time.
- (8) All personnel observe fire discipline.

Section V. COMMUNICATION

21. General

a. Effective communication is essential for control of the company and its elements. The company utilizes a combination of radio, wire, messenger visual, and sound communications to provide as many alternate means of transmitting messages as conditions will permit. (For use of radar as a means of communication, see appendix IV.) Within the mechanized rifle company, radio is the primary means of communication in all tactical operations, although wire may be used to augment existing radio nets. Wire can be used to advantage in assembly areas and during conduct of a defense.

b. The company commander is responsible for the installation, operation, and maintenance of the company communication system

and for its efficient functioning as part of the battalion system. He insures that his subordinates are properly trained and utilized to assist him in executing his communication responsibilities. The communication chief is the principal assistant to the company commander in communication matters.

c. Leaders and operators who habitually use the company's communication equipment are trained in its operation. In addition, as many others are trained in the operation of radios and telephones and the installation and maintenance of wire lines as conditions will permit. Such training in depth provides additional operator personnel required for sustained operations. Emphasis in training is placed on radiotelephone procedure and communication security.

d. Operation orders contain instructions pertaining to communications. These instructions include such items as the location of the commander or the command post, restrictions on the use of certain communication means, the allotment of available communication facilities, the designation of special prearranged visual or sound signals, and pertinent extracts from the SOI of higher headquarters. Throughout the operation, other instructions pertaining to communications are issued as required.

e. For additional information on communications, see FM 7-20.

22. Use of Communications

a. Effective communication is the result of a joint effort between units concerned, even though one of these units may have primary responsibility for establishing and maintaining communication with the other(s). In the event of a communication failure, all units concerned take immediate action to locate and eliminate the trouble and continue such action until contact is regained.

b. Radio and messenger are the primary means of communication for the offense and for other operations involving rapid and extensive movement. It is supplemented by visual and sound signals and, when possible, by wire. Additional radio communication may be made available to the company through the attachment of APC with an appropriate radio to the infantry and airborne infantry rifle companies. Operator proficiency and discipline are required to keep radio transmission as brief as possible. Consistent with instructions from higher headquarters, plans are made for the use of alternate radio frequencies and other communications means in the event of enemy jamming. For type company radio nets, see paragraph 23.

c. Wire and messenger are normally the primary means of communication in defense. Radio is used as soon as wire service is interrupted, or after the enemy has made contact, or when

ordered by higher headquarters. Two or more wire lines are installed over different routes. Every effort is made to recover the wire when it is no longer required. During withdrawals when it cannot be recovered, the last using unit removes sections of the wire or otherwise makes the wire system unusable. Visual and sound signals may be used to supplement wire in the defense when they will not compromise security. For type company wire systems, see paragraph 23.

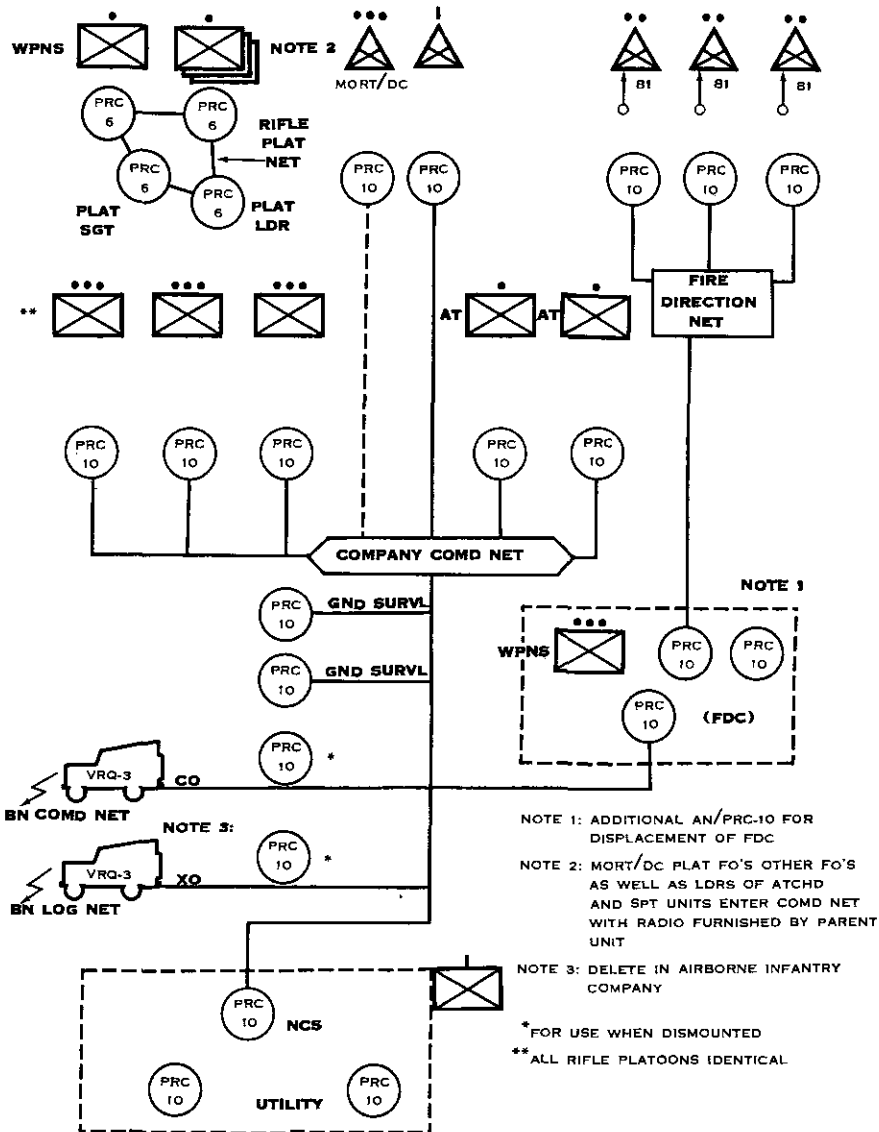

Figure 4. Type radio nets, rifle company, infantry and airborne infantry battalion.

d. Visual signals include organic panel sets, pyrotechnics, and smoke of various types and colors, arm-and-hand signals, flashlights, tracer ammunition, and improvised lights and flags. Instructions from higher headquarters normally prescribe the use of panel signals for ground-to-air communication and the use of pyrotechnics or smoke signals to call for, shift, or lift fires or illumination. The unit SOP normally prescribes arm-and-hand signals and flag signals. This SOP should include basic instructions for signaling helicopters.

e. Sound signals are normally used for alarms to warn of air, CBR, or ground attack or the imminent use of nuclear weapons. Their use is usually prescribed in SOP or SSI. Whistles, horns, gongs, small arms, or other noisemakers may be used for sound signaling.

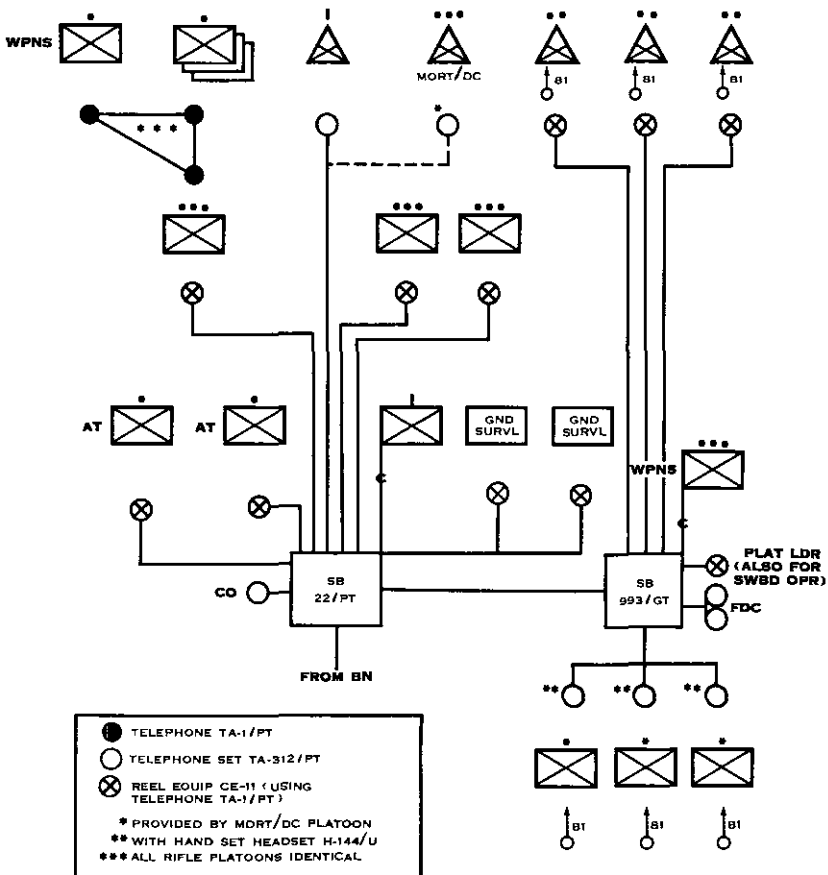

Figure 5. Type wire system, rifle company, infantry and airborne infantry battalion.

23. Type Radio Nets and Wire Systems

a. *Equipment.* For specific items of communication equipment organic to the rifle company, see appropriate current TOE. For capabilities, operation, and maintenance of specific items, see applicable 11-series technical manuals.

b. *Type Radio Net.* Type radio nets for the infantry and airborne infantry rifle companies are shown in figure 4. Type radio nets for the mechanized rifle company are shown in figure 6. Modification of these nets may be required in certain situations; such as to furnish radio communications to patrols, security detachments, or other elements.

c. *Type Wire System.* Type wire systems for the infantry and airborne infantry rifle companies are shown in figure 5. Type

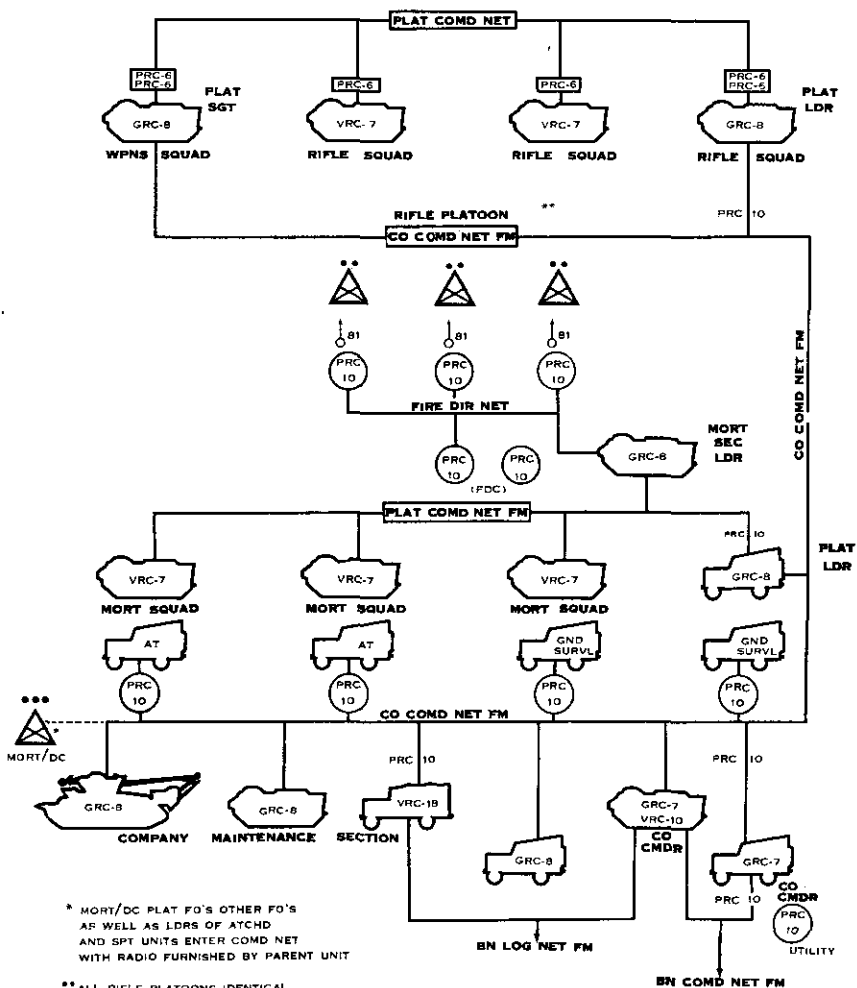

Figure 6. Type radio nets, rifle company, mechanized infantry battalion.

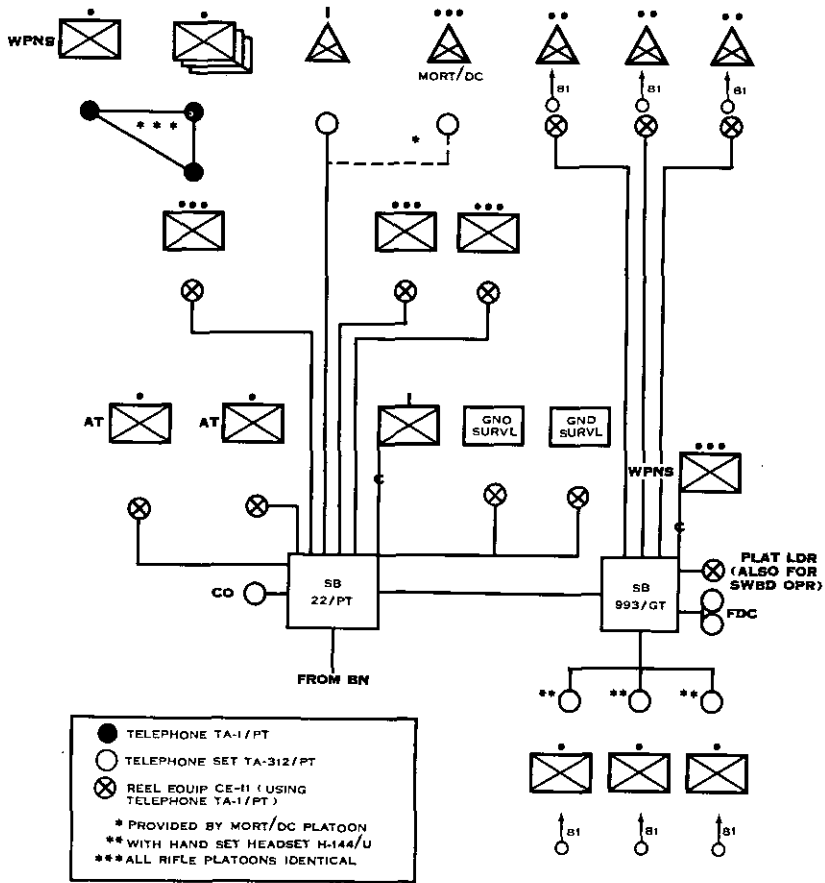

Figure 7. Type wire system, rifle company mechanized infantry battalion.

wire systems for the mechanized rifle company are shown in figure 7. These systems may have to be modified to provide telephone communication with listening posts, attachments, and other elements.

Section VI. COMMAND ASPECTS OF PATROLLING

24. General

a. A patrol is defined as a detachment sent out by a larger unit for the purpose of gathering information, securing prisoners of war, or carrying out harassing, destruction, mopping-up, or security missions. Patrols are classified by the type of mission they perform. The two general classifications of patrols are reconnaissance and combat. They differ in the mission assigned and in their actions. There are many variations in the size and organization of these patrols, ranging from two men to a company or larger

unit. Reconnaissance patrols avoid combat to the extent possible and normally obtain information through stealth or long range observation. Combat patrols normally fight to obtain information in addition to their execution of harassing or destruction missions.

b. While the battalion S-2 has primary staff responsibility for reconnaissance patrols and the S-3 primary staff responsibility for combat patrols, the company commander has overall responsibilities for patrol personnel provided by his unit. The company commander will check, rehearse, and give additional briefings to patrols from his company regardless of the initiating authority. Company directed patrols must be coordinated with the appropriate staff officer(s) at battalion in order to insure a coordinated patrol effort throughout the entire battalion area.

c. For further information on patrolling, see FM 30-7, FM 21-50, and FM 21-75.

25. Briefing and Debriefing Patrols

a. Normally battalion directed patrols are briefed by the appropriate member of the staff (S2, S3) and debriefed by the S2 or his representative. The patrol leader will keep the company commander informed of items on which briefed or debriefed by the battalion staff.

b. In combat operations, it will not always be possible for the appropriate staff officer to individually brief and debrief each battalion directed patrol. In such cases, necessary information must be given to the company commander to insure proper briefing or debriefing of patrols he is directed to dispatch by battalion.

26. Company Directed Patrols

Company directed patrols for the most part will consist of those patrols that the commander feels necessary for the maintenance of contact between elements of the company, and between the company and adjacent units; those patrols considered necessary to provide warning and security to the company from enemy activity; and those patrols utilized for reconnaissance of importance to the company.

27. Long Range Reconnaissance Patrolling

See FM 21-75 and FM 100-1.

CHAPTER 2

ADMINISTRATIVE SUPPORT

Section I. GENERAL

28. General

a. The company commander is responsible for the administrative and logistical functions of the company. These functions are vital to efficient operation and require continuous attention. The company commander selects and actively supervises subordinates in the performance of these functions. His principal assistant is the executive officer. The company commander requests assistance from battalion when required.

b. The procedures described in this chapter are a guide only. They are subject to modification by appropriate regulations, directives, and policies of higher headquarters. They are, primarily, the procedures used under combat conditions.

c. For duties of personnel having specific administrative and logistical functions, see chapter 1.

29. Battalion Administrative Support

For additional discussion of administrative support within the battalion, see FM 7-20.

Section II. PERSONNEL MANAGEMENT AND ADMINISTRATION

30. Personnel Areas of Responsibility

a. *Maintenance of Unit Strength.*

(1) *Strength records and reports.*

(a) In combat, the company morning report is prepared in the Personnel Services Division of the Division AG Section. It is based on feeder reports submitted by each company through battalion. The official morning report is signed by the personnel officer and forwarded to higher headquarters with the organizational copy (No. 2 copy) returned to the company for file.

(b) The company commander submits a daily on-line strength report which reflects the number of personnel who are on line (in battle positions or assisting in controlling the fighting elements) and who are not on line. This report is a modification of the daily status report used in garrison.

- (c) The company commander submits a daily strength message to battalion headquarters as prescribed by the battalion SOP. This message includes all changes affecting the unit's strength (daily losses and daily gains) and the number of prisoners of war captured and evacuated during the reporting period (normally 1800 hours to 1800 hours).
 - (d) The company prepares and forwards the Casualty Feeder Report (DA Form 1156) and Witness Statements of Individuals (DA Form 1155) to the battalion headquarters as prescribed by AR 600-66.
 - (e) The company submits nuclear radiation dosage reports as required by the battalion SOP.
- (2) *Replacements.* Replacements are requisitioned by the company commander submitted through battalion to the division AG Section. Replacements may be individuals, teams, or units. The company commander is responsible for receiving, orienting, and assigning replacements upon their arrival at the company.
- b. *Personnel Management.*
- (1) *Personnel procedures.* Personnel procedures are designed to assist the company commander in carrying out his responsibilities for personnel management. They include classification, assignment, reclassification, reassignment, appointment, reduction, officer efficiency reports, enlisted conduct and efficiency ratings, transfers, separations, and retirement. The company commander is responsible for insuring that these activities are carried out in accordance with Army Regulations and policies established by higher headquarters. He receives assistance and guidance from the battalion S1.
 - (2) *Prisoners of war.* The company commander is responsible for handling prisoners of war in accordance with the Geneva Conventions and for their evacuation to battalion. See FM 19-40 and FM 30-7.
 - (3) *Civilian personnel.* The company commander is responsible for civilian personnel management when civilians are utilized within his company (such as supply carriers, etc.). He insures that directives and policies established by higher headquarters are followed.
- c. *Development and Maintenance of Morale.*
- (1) *Personnel services.* Most morale problems can be overcome by the exercise of good leadership and the proper indoctrination and orientation of troops prior to operations. Personnel services are measures available to the

commander to assist in the attainment and maintenance of a high state of morale, and include such services as leaves and passes, rest and recreation facilities, character guidance, postal services, religious activities, exchanges, financial and legal assistance, and welfare and special services. The immediate objective of personnel services is to assist the commander in caring for the personal needs and welfare of his subordinates; the ultimate objectives are the stimulation of the individual's desire to contribute to the effectiveness of his unit and to conserve manpower.

- (2) *Awards and decorations.* The primary purpose of the awards and decorations system is to provide tangible evidence of public recognition of acts of heroism performed and valuable services rendered. The company commander is responsible for insuring that a sound awards and decorations policy is established within his unit in consonance with directives and policies established by higher headquarters. The following principles should be included in this policy:

- (a) No deserving act should go unrewarded.
- (b) No award or decoration should be given unless it has been earned.
- (c) When more than one person participates in an act which is rewarded, each participant should be rewarded in proportion to the extent of that person's participation.

- (3) *Graves registration.*

- (a) An efficient graves registration service assists in the maintenance of morale of combat troops and adequate battlefield sanitation. Enemy dead are treated exactly the same as our own, except they are segregated from our dead.
- (b) The company commander is responsible for collecting, identifying, and evacuating the dead and for safeguarding their personal effects. However, these functions will not be accomplished at the expense of the company's mission. The dead are normally evacuated to the brigade graves registration collecting point located in the brigade trains on available transportation returning to the rear, such as empty supply vehicles. The brigade graves registration collecting point is operated by a collection point and evacuation section of the graves registration platoon, which is attached to the supply and transportation battalion of the division

support command. Personal effects found on the body are never removed. Personal effects in company storage are screened, inventoried, and forwarded through supply channels. When the company is unable to evacuate the dead, the battalion may furnish assistance by providing personnel and transportation. Isolated burials are avoided unless evacuation is precluded due to the urgency of the situation. If isolated burials are performed, an overlay showing the exact location of such graves together with other pertinent information (i.e., names of deceased if known, and number of deceased buried) will be forwarded to battalion so subsequent actions can be taken to recover the bodies. Mass burials, when large numbers of deceased are placed in a common grave, will be accomplished only when authorized by appropriate authority.

d. Maintenance of Discipline, Law, and Order.

- (1) The company commander is responsible for the state of discipline of his unit. Discipline is the individual or group attitude that insures prompt obedience to orders and initiation of appropriate action in the absence of orders. Discipline results from training and is achieved by requiring discipline on the drill field, in barracks, and in the field. Discipline is closely associated with leadership and morale.
- (2) Law and order activities can be grouped into preventive and corrective measures. Preventive measures are those which encourage obedience and respect for authority by eliminating existing or potential causes of law violations. Sound leadership, orientation, private counseling, and fair leave and pass policies are examples of such measures. Corrective measures are those which deal with actual offenses which occur when preventive measures fail and include trial by courts-martial, nonjudicial punishment, apprehension, confinement, and rehabilitation.

31. Headquarters Management

The executive officer normally supervises the movement, security, internal arrangement, organization, and operation of the company headquarters and allocates shelter for troops in the headquarters area.

Section III. COMBAT SUPPLY

32. General

a. The company commander is responsible for the supply functions of his company and for the proper use of all supplies. His principal noncommissioned assistant is the supply sergeant. In combat, the supply sergeant normally supervises the activities of the company trains (par. 33).

b. The executive officer acts as the company supply officer in addition to his other duties. All officers and noncommissioned officers of the company have supervisory responsibility for supplies and equipment.

c. It is essential, for economical as well as tactical reasons, that authorized allowances of supplies and equipment be on hand, in serviceable condition, properly cared for, and that no excesses accumulate.

d. The procedures discussed in this section are normally appropriate for most combat situations. In some instances they may have to be modified to meet a particular situation.

e. In certain operations (particularly in restricted terrain) resupply by parachute and/or helicopter may be required. Normally this resupply will consist of high priority supplies and will be for short durations. For a discussion of the classes of supply and aerial resupply, see FM 7-20.

33. Company Trains

a. The company trains is the focal point for supply and maintenance operations for the company. The company commander selects the location of the company trains based on the recommendation of the executive officer. The area selected for the company trains is generally in the rear of the company area. Depending on the tactical situation, it may be near or within the company command post. The area selected should facilitate supplying the platoons, be at or near a good road or trail, be easily identifiable, provide concealment from ground and aerial observation, and afford cover from flat trajectory fires.

b. The supply facilities that are found within the company trains may contain fuel and lubricants, clothing and equipment, and part of the company's basic load of ammunition.

c. In the mechanized infantry rifle company, second echelon maintenance facilities for vehicles and weapons are located in the company trains.

d. In the infantry and airborne infantry rifle companies, second echelon maintenance for weapons only are located in the company trains.

34. Food and Water

a. Within the battalion there is a mess section organic to the battalion support platoon. This mess section operates a consolidated mess, normally in the battalion field trains, which feeds the entire battalion. The section has the capability of being fragmented so that it can support any company conducting an independent or semi-independent operation, or that is attached to another organization. The company commander may request that a team of cooks and kitchen equipment be attached to his company from the battalion mess section in order that he may operate his own mess.

b. The usual procedure for feeding consists of the company commander or his representative submitting an informal request to the battalion S4, advising him of the number of personnel to be fed and the location(s) where the food should be delivered.

c. Food may be prepared either in the company area or in the battalion field trains and brought to the company trains area where it is either transloaded to company transportation for delivery to the platoons or carrying parties are formed to carry the food to the platoons. Whenever possible, hot meals are served to the company from the battalion mess section. The food is brought forward in hot food containers and the troops are provided with mess trays or kits. Water is usually delivered with the food. When it is not feasible to obtain drinking water from engineer sources, local water is purified as needed in lister bags or directly in canteens.

d. Upon completion of the meal, the containers and mess trays or kits are collected by the mess personnel and are returned to the mess section in the battalion field trains where they are cleaned and prepared for the next meal.

e. There will be situations where hot meals cannot be served. In these cases individual rations will be issued to personnel for their own preparation. Every attempt should be made to serve hot meals.

35. Clothing and Equipment

a. The company normally enters combat with all its authorized TOE equipment (class II). Requests for replacement of these items are made by the company commander (or his representative) informally, either by telephone or message, to the battalion support platoon supply section. Requests for equipment destroyed by enemy action are submitted immediately. When an item becomes unserviceable, it will be turned in by the company in accordance with the SOP established by battalion.

b. Class IV items consist of those items of equipment which the unit requires over and above those prescribed by the TOE. Such items include fortification materials, additional weapons or equipment for a particular type of operation, and special equipment for varied climates. Requests for such items are processed through command channels. These items are normally distributed to the company trains along with the rations. When the need no longer exists for these items, they are returned, if appropriate, to the issuing agency.

36. Fuel and Lubricants

a. Usually there will be a class III resupply facility located within the company trains area.

b. For the mechanized infantry rifle company, this facility will consist of a 1,200-gallon tanker and a number of 5-gallon gasoline cans.

c. For the other types of rifle companies, this facility will normally consist of 5-gallon gasoline cans.

d. The company will submit an informal estimate of the class III needs to the battalion S4. The preferred procedure for supplying class III items to the company, is for the battalion to refuel the company in its present location. When this is not feasible, the company may have to send vehicles back to the battalion trains for refueling. This latter method should be avoided whenever possible, since unit distribution is the method desired for resupplying class III.

37. Ammunition

a. The supply sergeant coordinates the resupply of ammunition for the company. He uses the $\frac{1}{4}$ -ton truck and trailer of the company headquarters to carry a portion of the basic load of ammunition of the rifle platoons.

b. As the ammunition is expended, the rifle platoons notify the supply sergeant who, in turn, sends the ammunition to the platoon areas. If he is unable to use the $\frac{1}{4}$ -ton truck because of the terrain or enemy situation, the ammunition is delivered to the platoons by means of carrying parties. These carrying parties may come from the front line platoons or from the reserve platoon, depending upon the tactical situation.

c. The $\frac{3}{4}$ -ton trucks and trailers of the weapons platoon may be used for logistical as well as tactical transport. The company commander determines how many of these vehicles can be used for ammunition resupply after considering the displacement requirements of the weapons platoon against the anticipated ammunition expenditure and the resupply difficulties involved. The supply sergeant uses the allocated trucks and trailers to carry ammu-

dition for the company units. One or more $\frac{3}{4}$ -ton truck/trailers are parked at the mortar position. They are replaced with full trucks/trailers as they become empty. Ammunition is not normally stacked on the ground.

d. As ammunition at the company trains is expended, the supply sergeant frees a vehicle by redistributing its load among other vehicles. He gives the vehicle driver an informal request that shows the amounts and types of ammunition needed. The driver presents the request at the battalion combat train. The loaded vehicle then returns to the company trains.

e. Ammunition may be requested in excess of the authorized basic load in anticipation of expenditures if the excess is intended for immediate use. For example, additional ammunition for preparatory fires may be drawn and issued to the firing unit. When the excess ammunition is not fired as anticipated, this fact is reported to battalion. Battalion directs whether the ammunition is to be carried on unit transportation or turned in to battalion.

f. In defense, enough ammunition must be placed at weapon positions to permit continuity of fire. The amount is determined by making a careful estimate of the ammunition that will be expended before the weapons can be resupplied. Unfired ammunition is disposed of as described in *e* above.

g. Within the mechanized infantry rifle company, ammunition is delivered directly to platoon vehicles by the battalion support platoon. Trucks carrying mixed loads of ammunition are dispatched from the battalion combat trains upon request of the company commander. Company guides are designated to control delivery to all platoons. The platoon leader and platoon sergeant supervise the distribution of ammunition within the platoon. When conditions preclude direct delivery to each vehicle, the trucks are moved as far forward as practicable and the platoon vehicles are moved to the ammunition truck. If the tactical situation does not permit vehicle movement, ammunition is hand carried to the platoon vehicles. After supplying the company, ammunition trucks are returned to S4 control.

Section IV. COMBAT SUPPLY, AIRBORNE INFANTRY RIFLE COMPANY

38. General

a. For general supply responsibilities and functions, see paragraphs 32 through 37.

b. The discussion of phases of supply in this section applies to the other types of rifle companies in airlanded operations (see ch. 6).

c. The quantity and types of supplies and equipment carried by airborne assault forces are dictated by initial combat requirements and are influenced by such factors as aircraft availability, time of link-up or withdrawal, weather, and enemy capabilities.

d. A minimum of 2-days' supply should be maintained in the objective area (except for raids and relift operations), and when feasible, maintenance of a 3-days' level is desirable.

39. Phases of Supply

Phases of supply are accompanying supply, followup supply, and routine supply. Procedures vary with the category of supply being delivered.

40. Accompanying Supplies

a. Accompanying supplies are those supplies of all classes which accompany the unit into the objective area. These supplies consist of unit prescribed load (on individuals, in vehicles, and in aerial delivery containers) and additional supplies (in heavy drop and/or bulk loaded in assault aircraft). The company recovers or protects its own accompanying supplies.

b. The composition and distribution of the unit prescribed load depends essentially on the mission, tactical situation, and resupply situation. In general, the following fundamentals apply:

- (1) Accompanying supplies and equipment are combat loaded on personnel and in aircraft to facilitate the tactical operations of the unit. Critical items of equipment and supplies are distributed among aircraft so that the loss of a single aircraft does not result in loss of all such equipment.
- (2) Individuals enter the objective area with a minimum of one ration and one hundred rounds of ammunition or additional rounds as prescribed for their mission.
- (3) Crew-served weapons are dropped or airdropped with a prescribed initial supply of ammunition and with the weapon crew.
- (4) Radios of the company and battalion assault nets (AN/PRC-6 and AN/PRC-10) are carried into the objective area as part of the individual load of the operator.
- (5) Vehicle drivers are dropped near or airdropped with their vehicles.
- (6) Vehicles are dropped or airdropped with their fuel tanks filled to a safe level (generally $\frac{3}{4}$ full) and with enough additional gasoline in 5-gallon cans or other types of containers to provide a total of 250-350 KM of operation.

(7) Organic vehicles normally used as ammunition carriers are loaded with appropriate ammunition.

c. The company and each of its subordinate elements are responsible for the recovery of their own airdropped or airlanded items of their unit prescribed loads.

41. Followup Supplies

a. Followup supplies consist of preassembled supplies delivered direct to units in the objective area, and packed to correspond to anticipated daily requirements. Followup supply is classed as automatic and on-call.

b. Automatic followup supply is delivered to units in the objective area on a preplanned schedule. Automatic followup supply continues until replaced by routine supply procedures.

c. On-call followup supply is prepackaged and held in readiness in the departure area. It is delivered to units in the objective area on a specific request basis.

42. Routine Supplies

These supplies consist of replacement and consumption items delivered to the objective area in bulk, based on actual needs for distribution by normal supply procedures.

43. Resupply Within the Objective Area

a. Requests for resupply are made informally, by verbal or written message, to the battalion S4. The method used to resupply the elements of the company depends upon several factors, including the tactical situation, terrain, urgency, availability of vehicles, and distances involved. Any one or a combination of the following methods may be used:

- (1) Delivery by trucks of the battalion support platoon direct to the using element of the company.
- (2) Delivery by trucks of the battalion support platoon to the company trains, where the supplies are off-loaded and further distributed.
- (3) Pickup by company vehicles from the battalion support platoon. When this method is used, the executive officer or the unit supply sergeant coordinates the operation. Certain company vehicles may be pooled under company control for procuring and distributing supplies.
- (4) Aerial resupply directly to the company or its elements for further distribution or use.

b. The battalion S4 determines and recommends the method of resupply to be used in any operation. When trucks of the battalion support platoon are used, the following considerations apply:

- (1) Whenever possible, these trucks deliver supplies direct to the using element within the company.
- (2) Supplies off-loaded at the company trains are distributed as soon as possible to using elements. Normally, supplies are not stockpiled at the company trains.
- (3) Transfer of supplies from one vehicle to another is held to a minimum.

c. Gasoline is resupplied by bulk distribution to using equipment. When this method is impracticable, gasoline is resupplied in 5-gallon cans, with an empty can being exchanged for a full one.

d. Packaged rations are normally used during the assault phase of the operation. Rations are usually issued once daily; they are distributed during the night preceding the day of use.

Section V. MISCELLANEOUS LOGISTICAL ACTIVITIES

44. Medical Service

(See also FM 7-20.)

a. Within the infantry and mechanized infantry battalion, three company aidmen from the battalion medical platoon are normally attached to the company to give emergency medical treatment. The battalion medical platoon normally provides one aid-evacuation team to support each committed company, but provides additional teams when combat conditions require, each equipped with a frontline ambulance/APC. Operating mounted or dismounted these teams treat, collect, and evacuate patients within and from the company positions. Walking wounded are directed to the company aid post or to the battalion aid station. The company commander designates litter bearers or unit vehicles to supplement attached or supporting medical evacuation means as required.

b. Within the airborne infantry battalions, three company aidmen from the battalion medical platoon are normally attached to the company to give emergency medical treatment. Normally a company aidman accompanies each rifle platoon. Walking wounded are directed to the company aid post or a battalion aid station. Other patients are evacuated to an aid station by ambulances of the medical platoon or by litter bearers or vehicles designated by the company commander to supplement supporting medical evacuation means.

c. The company aid post normally operates in the general vicinity of the company CP. This facility is the place where casualties can be held pending further evacuation to the battalion aid station. In addition to serving as a platoon aidman for one of the

platoons, the senior medical specialist attached to the company supervises the operation of the company aid post.

45. Maintenance Procedures

a. General. Maintenance is all actions taken to keep material in a serviceable condition or to restore it to serviceability. It includes inspecting, testing, servicing, repairing, rebuilding, and evacuation. Proper maintenance of all equipment and supplies is essential to the combat efficiency of the company.

- (1) Maintenance within the infantry and airborne infantry rifle companies is generally limited to that which can be performed by the individual soldier and crew members (first echelon). Within the mechanized infantry rifle company it is generally limited to that which can be performed by the individual soldier and crew members (first echelon) as well as the maintenance section (second echelon) (see also par. 6). When additional maintenance is required beyond the capability of the company it is provided by the battalion headquarters company or higher echelon.
- (2) Within the infantry and airborne infantry rifle companies, the armorer normally operates in the company trains area where he has the necessary tools and equipment to provide second echelon maintenance for the company weapons.
- (3) In the mechanized infantry rifle company, the maintenance section normally operates in the company trains area where it provides second echelon maintenance (organizational) for company vehicles, weapons, and communication equipment.
- (4) Equipment which is beyond the repair capability of the company and the maintenance personnel of battalion is turned over to the forward support company of the division maintenance battalion, which is located in the brigade trains area. This company performs field maintenance on all types of equipment except medical and signal cryptographic equipment.

b. Weapons. First echelon maintenance of weapons is performed by the individual soldier, or crew members in the case of crew-served weapons. Second echelon maintenance is performed by the armorer. Weapons beyond the repair capability of the armorer are serviced by the battalion maintenance platoon, or the forward support company of the division maintenance battalion.

c. Communication Equipment. First echelon maintenance of communication equipment is performed by the assigned operator.

In the mechanized infantry rifle company, second echelon maintenance is performed by the radio mechanics of the maintenance section. The infantry and airborne infantry rifle companies have no organic second echelon maintenance capability. Communication equipment which cannot be made operable by the operator (and the maintenance section in the mechanized infantry rifle company) are serviced by the radio mechanics of the battalion communication platoon, or the forward support company of the division maintenance battalion.

d. Vehicles. Company commanders must place a high degree of emphasis on the maintenance of vehicles organic to their units. Within the mechanized infantry rifle company, vehicle maintenance assumes added importance since armored vehicles require a greater supply of fuel and lubricants and extensive maintenance. The maintenance and recovery of disabled vehicles pose problems, particularly during fast moving operations. Time must be allowed for maintenance and plans must be prepared to insure recovery of vehicles disabled during the operation.

- (1) Unit commanders are responsible to insure that drivers and/or crews perform first echelon maintenance on their vehicles. Each vehicle comes equipped with tools which permit the drivers or crews to perform this maintenance which includes inspecting, tightening, cleaning, and servicing with fuel, lubricants, coolants, and air. This maintenance must be performed before, during, and after operation of the vehicle as the situation permits. Drivers and crews should not make any repairs which are the responsibility of mechanics. Any maintenance defect which cannot be corrected by the drivers or crews is noted so that corrective action can be taken at the appropriate maintenance level.
- (2) Vehicle maintenance in the infantry and airborne infantry rifle companies is limited to first echelon since these companies do not have organic maintenance personnel and equipment to perform second echelon maintenance. Second echelon maintenance is performed by the battalion maintenance platoon. Although the company commander does not have an organic second echelon maintenance capability, he is still responsible to insure that second echelon deficiencies are detected and reported to maintenance personnel at battalion for appropriate repairs.
- (3) In the mechanized infantry rifle company, second echelon maintenance is performed on vehicles by the company maintenance section. Maintenance personnel at battalion render second echelon backup support.

- (4) Repairs on vehicles can be accomplished by a number of methods. The most desirable method is for mechanics at battalion level (and company level in the mechanized infantry rifle company) to go to the vehicle and repair it on site when the required maintenance cannot be accomplished by the drivers or crews. Used in this method mechanics are referred to as contact teams. If the extent of repair is such that it cannot be performed on site, the vehicle is evacuated to the battalion field trains (infantry and airborne infantry rifle companies) by the battalion maintenance platoon. In the mechanized infantry rifle company, the vehicle may be evacuated to the company trains by the company maintenance section, or if necessary, to the battalion field trains by the battalion maintenance platoon.
- (5) Another method of obtaining maintenance service beyond the capability of the driver or crew is for the company to bring the vehicle to the maintenance platoon at battalion (infantry and airborne infantry rifle companies) or the maintenance section at company level (mechanized infantry rifle company). This method is not as desirable as the use of contact teams described above. Regardless of the method employed, the important principle to be followed is that vehicles are repaired as far forward as the situation permits.
- (6) The bulk of second echelon maintenance is performed in the battalion field trains, although some second echelon maintenance may be performed in the battalion combat trains, and the company trains (mechanized infantry rifle company). The use of contact teams permits second echelon maintenance to be performed in other areas. The amount of maintenance performed in any area will vary with the tactical situation. In the infantry and airborne infantry rifle companies, the maintenance platoon leader will determine where the second echelon maintenance is to be performed. In the mechanized infantry rifle company, this determination will be made by the executive officer (who is also the company motor officer) and the battalion motor officer.

e. Reference. For additional discussion of maintenance procedures, see FM 7-20.

46. Miscellaneous Services

a. Exchange of Clothing. During actual combat, it is usually impracticable to issue clean clothing beyond the exchange of socks and underwear. Normally, clothing is exchanged while the com-

pany is in reserve or a rest area. Clean clothing may be issued in bulk to the company for further distribution, or it may be issued to individuals at a bath unit. Troops wash their own clothing when other facilities are not available.

b. Bathing of Troops. A bath unit may be available for use by the company on a schedule prescribed by higher headquarters. Uncontaminated streams may be used for bathing when such use does not contaminate water to be used for drinking or other more essential purposes. The availability of even crude bathing facilities is an important morale consideration.

c. Bedrolls. Bedrolls contain articles needed by the troops for their personal comfort, such as shelter halves, blankets, or sleeping bags. Rolls are usually carried on the trailer of the supply truck and are delivered to the company whenever the situation permits and warrants their use.

CHAPTER 3

OFFENSE

Section I. GENERAL

47. Mission

a. The mission of the rifle company in offensive action is to close with the enemy by means of fire and maneuver in order to destroy or capture him.

b. The mission of the weapons platoon is to furnish close and continuous fire support for the attacking rifle platoons and to provide antitank protection for the company. In addition to providing AT protection, the AT squads may provide close fire support to the attacking rifle platoons.

48. Employment of the Rifle Company

The battalion commander assigns a mission(s) to the company and designates attached and/or supporting units. The mission of an attacking rifle company is usually expressed in terms of terrain objectives to be seized. The battalion commander assigns the company either a zone of action, an axis of advance, a direction of attack, or a combination of these. The company may be all or part of the main or supporting attack of the battalion, or it may be all or part of the battalion reserve. With the exception of paragraphs 75 through 87, this chapter utilizes the infantry rifle company as the basic organization. The company may be dismounted, motorized, mechanized (pars. 75-87), or transported by aircraft (ch. 6). For a discussion of offensive maneuvers in which the company may participate as part of the battalion, see FM 7-20. For a discussion of the employment of the rifle platoon, see FM 7-15.

49. Concept of Offensive Operations

Rifle elements close with and destroy the enemy utilizing supporting fires to the maximum. Rapid maneuver, dispersion, and the use of tactical surprise will reduce the effectiveness of enemy fires.

Section II. PREPARATION FOR THE ATTACK

50. Actions of Leaders

a. *Actions of the Company Commander.*

- (1) The company commander normally receives a battalion warning order which permits early planning and the initiation of preparations for the attack. The warning

order is usually fragmentary and may contain such information as the time of the attack, mission, preliminary plan for the employment of elements of the battalion, information pertaining to the issuance of the battalion attack order, and administrative instructions necessary for proper preparation. The company commander in turn, normally issues a warning order to his subordinates.

- (2) Based on the battalion warning order, the company commander decides who will accompany him when he goes to receive the battalion order. He normally takes with him the weapons platoon leader, artillery forward observer, leaders or representatives of other attached or supporting units, his communication chief, and a radio-telephone operator. This provides appropriate leaders or their representatives immediately available to the company commander after receipt of the order to assist him in formulating his plan of attack.
- (3) The plan of attack consists of a scheme of maneuver and a fire support plan. These are developed concurrently, since they are interrelated. In developing his plan of attack, the company commander keeps in mind the accomplishment of his mission in the shortest possible time and with the fewest casualties. He strives to develop a plan which is simple yet complete, provides for flexibility, achieves surprise, directs the major effort against the principal objective(s), and minimizes the vulnerability of the company to nuclear and nonnuclear fires and to CBR attack. For more information concerning protection against nuclear attack, see FM 21-40 and FM 21-41.
- (4) For a discussion of the actions of the company commander in formulating his plan, issuing his order, and supervising the preparation of the company for action, see appendix II.

b. Actions of the Rifle Platoon Leader. The platoon leader normally receives the warning order from the company commander which gives him fragmentary information and instructions on the time and place to report to receive the company order. Based on this information, he issues his warning order to his subordinates and starts the platoon preparations. The platoon leader, normally accompanied by one man to act as a guide, reports to receive the company attack order. The platoon sergeant and/or squad leaders may also accompany him when it appears their assistance will be needed for reconnaissance and coordination. In the absence of the platoon leader, the platoon sergeant or senior squad leader, as appropriate, supervises platoon preparations for the attack. For

a more detailed discussion of the actions of the rifle platoon leader and squad leaders, see FM 7-15.

c. Actions of the Weapons Platoon Leader.

- (1) The weapons platoon leader normally accompanies the company commander to receive the battalion attack order. Before doing so, he issues a warning order to his platoon sergeant. After receipt of the battalion order, the company commander may direct the weapons platoon leader to accompany him on his reconnaissance or to conduct a separate reconnaissance. Based upon the battalion order, the company commander's concept for the attack, and his own reconnaissance, the weapons platoon leader decides what recommendations to make on the employment of his platoon. If general or direct support appears to be feasible, he prepares recommendations on general position areas, disposition of forward observers, methods of displacement (par. 66), and targets (par. 60). During his reconnaissance, the platoon leader makes a thorough terrain analysis. He selects principal directions of fire for the antitank section and general firing position areas for the antitank squads and mortar section subject to the company commander's approval of his recommendations. During this time, the platoon prepares for the attack, normally under supervision of the platoon sergeant.
- (2) If the company order attaches squads to rifle platoons, the weapons platoon leader insures that the leaders of those squads report to their respective rifle platoon leaders as soon as possible.
- (3) When time permits, the weapons platoon leader makes an additional reconnaissance after the company attack order is issued. He issues his attack order as soon as possible, giving the section and squad leaders maximum time to make their preparations. Whenever possible, he orients his leaders from a terrain vantage point. If he cannot do this, he uses a map, sketch, or an improvised sandtable. In addition to other information, his order includes the method of employment of each squad and, if in general or direct support, the general position areas, disposition of the mortar forward observers, principal directions of fire and targets for the antitank squads, and tentative plans for displacement. (See also app. II.)
- (4) The section and squad leaders, in turn, reconnoiter, select exact firing positions, and coordinate with rifle platoon

- leaders to learn what routes the rifle platoons will use. They normally issue their orders in the assembly area.
- (5) When a squad is attached to a rifle platoon, the squad leader may make recommendations to the rifle platoon leader on the employment of his squad, to include the general position area, targets, and plans for displacement. The rifle platoon leader controls the squad.
 - (6) As soon as possible, the platoon leader (assisted by the platoon sergeant and the fire direction computers) prepares a plan, usually in overlay form, of 81-mm mortar fires to support the attack. This plan is given to the forward observers and to the company commander, generally with enough copies to issue one to each rifle platoon leader and one to be forwarded to battalion.

51. Preparation of the Company for the Attack

a. Prior to the attack, the company may occupy an assembly area which is normally designated by the battalion commander. In the assembly area, elements of the company are dispersed to the maximum extent practicable to reduce vulnerability to enemy fires. Advantage is taken of available concealment and cover, and maximum use is made of camouflage. Elements of the company are disposed to permit all-round defense, if required. Individual shelters are dug; security is posted to prevent surprise by enemy ground or air action; and antitank weapons are positioned to provide protection against enemy armor attack.

b. Normally, the preparations for the attack are completed while the company is in the assembly area. These preparations include reconnoitering, formulating plans, and issuing orders, as well as the following:

- (1) Additional ammunition is drawn and distributed.
- (2) Weapons, vehicles, equipment, and personnel are checked for readiness. Vehicles are refueled (topped off) and given necessary lubricants.
- (3) Equipment not needed for the attack is collected and stacked for later pickup.
- (4) Extra or special equipment needed for the operation is obtained and issued.
- (5) Troops are allowed to rest to the maximum extent possible consistent with security, briefing(s), and preparations for the attack.
- (6) Maps or map substitutes are prepared and issued to subordinate leaders including, as a minimum, platoon and attached unit leaders.
- (7) Organic vehicles join their respective units as required.

- (8) Units attached to the rifle company may join the company.
- (9) Communication equipment is checked for serviceability, and necessary frequencies and call signs are issued together with any special communication instructions.
- (10) Specialized training and rehearsals are conducted as required.

Section III. PLANNING THE ATTACK

52. General

a. The plan of attack includes a scheme of maneuver and a plan of fire support.

b. Sound and timely planning for the attack is important since improperly conceived plans or delays increase the vulnerability of the company and jeopardize chances for success. In nuclear warfare, with emphasis on speed and aggressiveness, the time available for planning may be short, therefore the company commander and subordinate leaders must make maximum use of the logical steps and thought processes incorporated into the estimate of the situation (par. 14) and troop leading procedures (app. II).

53. Scheme of Maneuver

a. The scheme of maneuver is the plan for the placement and movement of maneuver elements to accomplish the mission. The company maneuver elements are the rifle platoons, and tank platoons when attached. Included in the scheme of maneuver are the following: organization for combat; control measures; formations; use of the reserve; provisions for security, reorganization, consolidation, and dispersal; and plan for continuation of the attack.

b. Each maneuver element is given a specific mission prescribing its role in the scheme of maneuver. Missions assigned to attacking platoons are usually in terms of terrain objectives to be seized. The company commander gives his platoon leaders maximum freedom of action consistent with the overall plan.

c. In determining the scheme of maneuver, the company commander considers the means of mobility provided by the battalion commander.

d. The discussion of the scheme of maneuver contained in this section pertains primarily to a dismounted daylight attack; but it is generally appropriate for all types of attack, with minor modification and amplification. For special considerations involved in formulating the scheme of maneuver for other types of attack, see applicable sections of this chapter.

54. Control Measures

The company commander controls the maneuver elements in the attack by utilizing the control measures listed below. To give his subordinates maximum freedom of action, he prescribes the minimum control measures necessary to insure the progress of the attack in the desired manner.

a. Time of Attack. This is usually prescribed in the battalion order. It is the time when the leading element of the attacking companies must cross the line of departure. In conjunction with the line of departure, the time of attack assures the commander that his attacking elements and fire support units are coordinated at the beginning of the attack.

b. Attack Position. This is normally the last concealed and covered position short of the line of departure which is occupied by elements of the company to allow final coordination and other last minute preparations, and to deploy in the initial attack formation. On occasion, the attack position need not be designated.

- (1) A halt in the attack position is made only when final preparations cannot be completed in the assembly area or on the move. Any unnecessary delay in an attack position needlessly exposes the unit to enemy fires and may reduce the degree of surprise which can be achieved. It is particularly undesirable to use an attack position for a passage of lines.
- (2) The attack position is normally selected by the company commander, except when close control by the battalion commander is required, as in a night attack or attack of a river line. Desirably, an attack position offers concealment and cover from enemy observation and direct fire, is easily recognizable on the ground, and is large enough to accommodate the company, adequately dispersed, in the initial attack formation.
- (3) An attack position should be occupied for the minimum time necessary.

c. Line of Departure (LD).

- (1) A line of departure is a line designated to coordinate the beginning of an attack. Desirably, it should be easily recognizable on the ground, generally perpendicular to the direction of attack, under control of friendly units, and not under enemy direct fire or observation. For units not in contact, a line of departure is normally prescribed for their employment based upon terrain. When the line of departure cannot be fixed on terrain, the line of contact may be designated as the line of departure (LD is LC).

- (2) In some instances, the LD specified by the battalion commander may be unsuitable for elements of the company. When this occurs, the company commander may select and use a company LD in the immediate vicinity of the battalion LD, but the company must cross the battalion LD at the time specified in the battalion order.
- (3) If the LD is the line held by another unit already in contact with the enemy, coordination is required to insure the uninterrupted passage of lines in order to minimize the time that a remunerative nuclear target is presented. Speed and secrecy are emphasized. When possible, plans are made for the attacking elements to be guided through gaps between elements in contact.

d. Zone of Action. A zone of action is an area bounded by the line of departure, final objective, and boundaries on one or both flanks. Boundaries on unexposed flanks are specified, but the boundary on an exposed flank may not be specifically designated. A unit is free to maneuver and fire throughout its assigned zone to accomplish its mission. When the commander of a unit desires to enter or fire into the zone of an adjacent unit, he coordinates the matter with the adjacent unit commander and notifies the next higher commander of the action. Except in an airborne operation, a unit is not required to clear enemy resistance from its zone unless specifically directed. It may bypass enemy resistance which does not jeopardize the accomplishment of its mission, provided such action is promptly reported to the next higher commander. Zones of action are normally used for control in dismounted attacks.

- (1) Boundaries defining a zone of action extend only as far as the particular situation requires. Normally they will extend sufficiently forward of the objective to provide for positioning of local security posts forward of the consolidated position. They are usually drawn along easily recognizable terrain features in such a manner that division of responsibility for key terrain features is avoided. If one flank of the company is exposed, the battalion commander does not normally designate a boundary on that flank. In this case, the company commander determines the width of his zone by analyzing the mission, mobility of the company, and the ability of elements of the company to maneuver in the zone without risk of defeat, and by determining the presence and location of reconnaissance elements on the flank.
- (2) A platoon zone of action should include at least one adequate avenue of approach to the platoon objective. In selecting boundaries between platoons, the company com-

mander avoids dividing avenues of approach or key terrain features between two platoons. Platoon boundaries are normally designated on the ground in terms of easily recognizable terrain features. If platoon zones of action are prescribed and an overlay is issued in conjunction with the attack order, boundaries are shown on the overlay.

- (3) When a platoon leader desires to maneuver or fire in the zone of an adjacent platoon of the company, he coordinates with the adjacent platoon leader and notifies the company commander. When a platoon leader desires to maneuver or fire in the zone of an adjacent company, the company commander must coordinate the action with the adjacent company commander and notify the battalion commander.

e. Axis of Advance. This is a line of advance extending in the direction of the enemy and indicating the *general* route along which attacking elements will move. It is most frequently used as a control measure in fluid or mechanized operations. A unit moving on an axis of advance may bypass enemy forces which do not jeopardize the accomplishment of its mission provided the next higher commander is promptly informed of such bypassing. Deviation may be made to bypass obstacles, however a major deviation must be reported. The axis of advance is represented on a map or overlay by an "open" arrow, labeled "Axis of advance," starting at the line of departure or other designated point and continuing to the objective.

f. Direction of Attack. A direction of attack is a specific direction or route which the main attack or center of mass of the unit will follow. The terrain along the direction of attack must be cleared of effective enemy resistance. Because of its restrictive nature, a direction of attack is normally used only when a commander must maintain close control over the maneuver of subordinate elements to accomplish a closely coordinated scheme of maneuver. It is often used to designate the direction of a counter-attack. A direction of attack is represented graphically by an unlabeled arrow.

g. Checkpoint. This is an easily identifiable point on the terrain used either to control movement or as a reference point for reporting the location of friendly units or other information (enemy activity, obstacles, etc.). It may be used "in the clear" to report the location of units or to designate targets for supporting weapons. The company commander may designate as checkpoints those terrain features to which rapid reference may be required

during the conduct of the attack. For simplicity, the number of checkpoints designated is held to a minimum consistent with anticipated needs. A checkpoint is represented graphically by a circle with the checkpoint number inside.

h. Contact Point. This is a point on the terrain where two or more units are required to make physical contact. Contact points are seldom designated by the company commander for use during the attack, except as required after seizure of the objective when platoons have dispersed. A contact point is represented graphically by a square with the number of the contact point inside.

i. Phase Line. A phase line is a line utilized for control and coordination, usually a terrain feature extending across the zone of action. It is located on an easily recognizable terrain feature such as a ridge line, stream, or road. It is used to control the forward movement of units. Units report arrival at (and sometimes clearance of) phase lines, but do not halt unless so ordered. A phase line may be used to limit the advance of attacking elements.

j. Final Coordination Line (FCL). This is a line used to coordinate the lifting and shifting of supporting fires and the final deployment of the attacking echelon in preparation for conducting an assault against an enemy position. It is located as close to enemy positions on the objective as attacking troops can move before becoming dangerously exposed to friendly supporting fires. It should be recognizable on the ground. *Ideally, it should have concealment and cover.* When a requirement exists for two or more elements of a unit to assault simultaneously, elements of the attacking echelon may be halted to await the arrival of other elements.

(1) When enemy positions are known and supporting fires can be carefully planned in advance, the company commander may select a tentative FCL while planning the attack. He normally selects a tentative FCL only for those objectives on which a coordinated assault by two or more platoons is planned, leaving the selection of other FCL to the platoon leader.

(2) Often, an FCL cannot be selected ahead of time. It may be selected or changed during the attack (par. 65).

k. Objectives. An objective is a designated locality or geographical feature to be captured or reached in the course of an attack or during movement. Assigned objectives will be seized and controlled. Based upon his estimate of the situation (par. 14), the company commander may subdivide the company objective(s) into platoon objectives and, in addition, assign such intermediate platoon objectives as are necessary.

- (1) Objectives may be—
 - (a) Terrain which dominates all or the major portion of the company zone or axis of advance and which, if occupied by the enemy, would jeopardize the accomplishment of the mission.
 - (b) Terrain on which difficult combat is anticipated, indicating a need for a period of reorganization.
 - (c) Terrain from which a coordinated attack will be launched.
 - (d) Terrain required for purposes of control, as in areas where observation is limited or where distances involved require displacement of supporting weapons.
- (2) Terrain features selected as platoon objectives should have as many of the following desirable characteristics as possible:
 - (a) They are easily recognizable on the ground.
 - (b) They should provide for convergence of effort.
 - (c) They are within effective range of the company 81-mm mortars.
 - (d) They are neither too wide nor too deep to be controlled by the platoon after seizure. (Normally the platoon seizes the dominant portion of the objective in its assault.)
- (3) The number of objectives selected should be the minimum required to maintain control, coordination, and the progress of the attack in the manner desired by the commander.

55. Company Formations

a. In formulating his scheme of maneuver, the company commander determines how many rifle platoons he will use in the attack echelon and how many he will retain in reserve. The initial attack formation is the initial disposition of the rifle platoons as they cross the LD. It is changed, as required, during the conduct of the attack.

b. The company commander plans to employ all of the combat power necessary to insure success. He will utilize as many platoons and as much fire support as are necessary to insure accomplishment of the mission. While there are no fixed sets of conditions which will determine the most appropriate formation for a given situation, the following may serve as a guide:

- (1) A formation of one platoon in the attack and two platoons in reserve provides limited firepower to the front but a strong reserve. This formation may be appropriate when information of the enemy is vague or when the

company has one or both flanks exposed; when only a single, narrow avenue of approach is available, and/or when attacking to seize a deep objective as in mechanized operations.

- (2) A formation of two platoons in the attack and one platoon in reserve provides moderate firepower to the front consistent with retaining a reserve large enough to influence the action. This formation may be appropriate when relatively detailed information of the enemy is available.
- (3) A formation of three platoons in the attack provides maximum firepower to the front, but provides no reserve with which to influence the action. This formation may be appropriate when a wide area must be cleared rapidly or when the feasibility of using a reserve is limited, as in a night attack or attack of a river line.

56. Use of Company Reserve

a. The reserve is the portion of the rifle company withheld from action at the beginning of an engagement so that it will be available for employment at a decisive moment. It is employed to insure the success of an attack or to maintain its momentum, but it may be ordered to accomplish, or be prepared to accomplish, other specific missions. Appropriate missions may include one or more of the following:

- (1) *Protect one or both flanks of the company.* Normally, this is done with flank combat patrols. The company commander usually prescribes the size of these patrols and he may control their movement. The entire reserve may be echeloned to protect the exposed flank.
- (2) *Maintain connecting group contact with adjacent units.* The size and actions of connecting groups are normally prescribed by the company commander. Control may be exercised by either the company commander or the reserve platoon leader.
- (3) *Attack from a new direction.* The company commander commits his reserve to maintain or regain momentum of the attack, maneuvering the reserve against the enemy flank or rear.
- (4) *Assume the mission of the attacking platoon(s).* If the attacking echelon, or a portion of it, has become disorganized or ineffective because of heavy casualties, the reserve may replace it. The commander should commit it in a new direction rather than through the disorganized element.
- (5) *Mop up a position which has been overrun or bypassed by the attack echelon.*

- (6) *Protect the reorganization and consolidation of the attack echelon.* The reserve may be employed in whole or in part to protect a flank, to complete a company perimeter, to install protective minefields, or to outpost or patrol to the front and flanks of the attacking echelon during reorganization and consolidation.
 - (7) *Assist the assault echelon with the fire of the machineguns of its weapons squad.* The machineguns may be placed in position along the LD to support the attack by firing at enemy positions on the objective or along the route of the assault echelon. The machineguns should revert to the support of the reserve platoon when needed.
- b. The reserve is positioned where it can best perform its assigned mission(s).
- (1) The company commander prescribes the initial location(s). It is often in a concealed and covered area a short distance back of the LD, but the assignment of certain reserve missions may dictate otherwise. The commander plans subsequent, easily identifiable locations to keep the reserve far enough forward to be available immediately to influence the action. The reserve usually displaces from one location to another on order of the company commander.
 - (2) The company commander may place all or part of his reserve in the zone of the rifle platoon expected to make the best progress, or he may echelon all or a part of it toward an exposed flank. If there is a large gap between attacking platoons, he may have the reserve follow between them.

57. Security

a. Security is the responsibility of each leader in the company, regardless of the measures taken by higher commanders. The company commander plans for security against enemy air and ground action. Security measures are designed to protect the unit by providing warning in time to permit the necessary repositioning of forces or other action to meet the threat.

b. The company may attack with one or both flanks exposed. The company commander may position all or part of his reserve to protect an exposed flank, use combat patrols to protect it, and/or plan fires to cover likely avenues of approach into the flank.

c. Connecting groups, which periodically report the location of the flank of adjacent units, and aerial observers add a degree of security by providing the company commander with information regarding the situation on the flank.

d. The close-in security of the command post is normally provided by personnel available at the command post under the supervision of the executive officer. The security of the command post is increased when it is located near reserve elements or weapons positions.

e. See chapter 7 for security in movements to contact.

f. See appendix IV for employment of the ground surveillance section.

58. Reorganization and Consolidation

a. The company commander prepares plans for the reorganization and consolidation after seizure of an objective. These plans, announced in the attack order, are necessarily tentative and may be changed as required during the conduct of the attack.

b. Consolidation is the organizing and strengthening of a newly captured position so that it can be used to defend against an enemy counterattack. The plan for consolidation includes the responsibilities of rifle platoons for defending assigned areas, the designation of general position areas and missions for organic and attached weapons and tanks, the use of patrols to maintain contact with the enemy, and security measures. The plan may also designate contact points between dispersed platoons to further delineate areas of platoon responsibility. The platoon areas assigned for consolidation normally block enemy approaches to the objective.

c. Reorganization is the restoration of order in a unit accomplished by replacing casualties if possible, reassigning men if necessary, replenishing the ammunition supply, and performing whatever other actions are necessary or possible in order to prepare the unit for further operations against the enemy. The plan for reorganization includes such items as special instructions regarding ammunition resupply, vehicular movement, reporting of casualties, and the movement and general location of the command post.

59. Continuation of the Attack

a. When the attack is to be continued beyond the initial objective, the company commander makes a preliminary plan for it while making his plan for the initial attack.

b. The preliminary plan is based on a detailed map and aerial photograph study, ground or air reconnaissance, and instructions received from the battalion commander. Preliminary planning reduces the time required for reconnaissance and troop leading after seizure of the initial objective. The plan includes the employment of the rifle platoons and attached tanks, including any anticipated changes in formation, the employment of supporting weapons, and new missions to be assigned the reserve.

c. The company commander includes as much as practicable of the plan for the continuation of the attack in the initial company attack order.

60. Fire Support Planning

a. The fire support plan supports the scheme of maneuver and is developed concurrently. It represents the company commander's decision on the use of all available fires, including those of organic, attached, and supporting weapons. This plan includes targets to be taken under fire, time of delivery of fire, duration of fire, types of fires and weapons to be used, means of communication, and time for displacement, where applicable. The plan is based on the company commander's scheme of maneuver, information received from battalion, information of the enemy, the terrain, and on the recommendations of fire support unit leaders or their representatives.

b. The artillery forward observer is normally the company commander's principal assistant in fire support planning. He makes recommendations on the use of supporting fires and, if appropriate, air strikes and naval gunfire. Based upon the company commander's decision, he forwards requests for fires to the FSC located at battalion. Other individuals who assist the company commander in fire planning are the weapons platoon leader and leaders or representatives of attached or direct support units. They make recommendations on the use of fires of their units. Leaders of organic and attached units also make recommendations concerning position areas and methods of displacement for their units.

c. In developing his fire support plan, the company commander considers such items as the nature of the target, effects desired, weapons capabilities, and availability of ammunition. In general, he plans fires to neutralize known and suspected enemy positions to permit the rapid movement of maneuver elements to seize and consolidate the objective. These fires may be planned as scheduled or on-call fires. Often, the fires available cannot effectively engage all known or suspected enemy positions simultaneously. Consequently, the company commander must decide which enemy positions are likely to have the greatest effect on the accomplishment of the mission during various phases of the attack and plan his fires to neutralize them at appropriate times. He may plan on-call fires to cover likely enemy avenues of approach into the flanks of the company and to support the consolidation of the objective. The fire support plan normally provides the greatest concentration of fire on enemy positions on the objective just prior to the assault.

d. The company commander is notified of the approval or disapproval of the fire requests he submits to higher headquarters.

He changes his fire support plan as required to compensate for the support requests that are disapproved.

e. Fire support from a unit in contact may be made available to an attacking rifle company passing through or around its position. After coordination, the attacking company commander integrates the additional supporting fires into his company fire support plan.

f. The company commander may assign the reserve platoon(s) the mission of supporting the attacking platoon(s) by machinegun fire (par. 56). When he assigns such a mission, the company commander normally designates initial position areas and targets for the machineguns.

g. Smoke can be used effectively to reduce hostile observation and conceal the attacker's maneuver, to mark targets, and as visual signals. As the use of smoke must be approved by the highest echelon affected by the smoke, the company commander generally coordinates with the battalion commander.

h. Toxic chemical fires are authorized and coordinated by higher headquarters. Portable or mechanized flame support may be provided. The company commander integrates the flame support into his fire support plan.

i. Close air support may be furnished to the rifle company on an immediate request or preplanned basis. Preplanned requests for support of the company scheme of maneuver are submitted to the battalion S3 Air. Immediate air strikes may be obtained against targets of opportunity by requests through command channels to the battalion S3 Air, or through the artillery forward observer.

j. The company commander insures that communications are adequate to control fires during the attack. Control measures may include radiotelephone brevity codes and visual signals to be used in shifting, lifting, or calling for fires, as appropriate.

k. The company commander's responsibility for planning and employment of nuclear weapons is the same as for any other fire support available to him. Decisions concerning the employment of nuclear weapons allocated to the company rest with the company commander within restrictions imposed by the battalion commander. The company commander must insure that both nuclear and nonnuclear fires are completely integrated. He does this whether the nuclear fires are specifically controlled or requested by him or are planned and directed by higher headquarters. When surface or subsurface bursts of nuclear weapons are authorized by appropriate higher authority, added tactical advantage may accrue to the company through the use of radio-active fallout which occurs.

l. For additional discussion of fire support planning and coordination, see FM 7-20.

61. Employment of Organic and Attached Weapons

a. The 81-mm mortar section is employed in general support whenever centralized control will permit delivery of fires in support of all or the major portion of the company throughout the zone or along the axis of advance. Forward observers of the weapons platoon are positioned as directed by the company commander (par. 66).

b. The antitank section is employed in general support whenever centralized control will permit the squads to provide antitank protection for the company or, if appropriate, close fire support for the attacking platoons. Considerations in determining the method of employment include the ability of the company commander to control the section throughout the attack and the ability of the section to move rapidly throughout the area of operations to meet an armor threat.

c. The company commander employs attached fire support units in general support whenever the mobility of these units, the capabilities of their weapons, and control considerations permit them to provide the desired fire support under centralized control. Davy Crockett (launcher) will normally be employed in general support of the battalion or in direct support of the company. For details concerning the employment of Davy Crockett, see FM 7-20.

Section IV. CONDUCT OF THE ATTACK

62. General

a. Once launched, the attack is conducted aggressively until the objective is seized. Attacking units move forward as rapidly as possible, keeping the enemy off balance and allowing him no time to react. Enemy weaknesses are exploited whenever detected. Leaders at all echelons retain flexibility of action, and exhibit initiative, altering plans as required by the situation.

b. The company commander goes where he can best influence the action of the company. He makes maximum use of the chain of command within his company to insure efficient operation and control. He makes a continuing estimate of the situation and is alert to the possible courses of action open to him when new and changing situations occur. He remains constantly abreast of the situation and keeps his subordinates and the battalion commander informed at all times. When a situation develops which is beyond the capability of the company, the company commander requests assistance from the battalion commander.

c. The company commander influences the action by the control and efficient use of his supporting fires, by his personal presence, and by the timely and efficient employment of his reserve.

63. Movement From the Assembly Area to Line of Departure

a. The movement forward from the assembly area is frequently made under control of the executive officer who acts on the company commander's instructions. Often the platoons will be under the command of the platoon sergeant or senior squad leader for this movement. Departure from the assembly area is timed so that the movement to and across the LD will be continuous or, if an attack position is used, so the company will arrive at the attack position at the appropriate time (par. 54). The order of march prescribed should facilitate deployment into the initial attack formation or occupation of the attack position, as appropriate. Multiple routes forward may be used to facilitate deployment while on the move. Weapon elements may precede the remainder of the company in order to occupy firing positions.

b. If an attack position is used, platoons post security and occupy assigned areas generally in their initial attack formations. Final preparations for the attack are completed. Movement from the attack position is timed so that the leading elements of the company cross the LD at the prescribed time. If no attack position is used, deployment into initial platoon and squad attack formations is accomplished on the move.

c. If the company is to pass through another unit already in contact, the movement should be made rapidly and with the greatest possible secrecy to minimize vulnerability to a nuclear attack. Responsibility for the zone normally is transferred from the unit in contact to the attacking company at the time of attack.

64. Movement From the Line of Departure to the Final Coordination Line

a. Using the concealment and cover provided by the terrain and the protection afforded by supporting fires, the attacking platoons move rapidly toward their assigned objectives. Based on the enemy, terrain, and effectiveness of friendly supporting fires, some units may advance while others are held up. If an attacking platoon is subjected to effective small arms fire before launching its assault, the platoon(s) returns fire and requests supporting fires to help neutralize the enemy position. Depending upon the mission, the platoon may bypass the neutralized enemy position and continue toward its objective, or it may employ fire and maneuver and/or, fire and movement to eliminate the enemy resistance. (See ch. 2, sec. I, FM 7-15 for a discussion of platoon

fire and maneuver and fire and movement.) If the attack echelon is subjected to hostile artillery or mortar fire, it moves rapidly through or around the impact areas. Platoons not stopped by enemy fire continue forward even though adjacent units are halted. This advance may outflank enemy resistance holding up adjacent units, making it possible for flanking fires to be delivered against the enemy and for other elements to maneuver against his flank or rear. The application of fire alone normally results in a stalled attack and unnecessary casualties.

b. The company commander keeps abreast of the progress of the attack by observation and through radio contact with his platoon leaders. Throughout the attack, he closely coordinates the movement of his attack echelon and the fires of supporting weapons. To save time and reduce casualties, he keeps the attack progressing rapidly under the protection of supporting fires. He displaces the reserve to keep it close enough to the attack echelon to be committed rapidly (par. 56). He anticipates situations requiring the commitment of the reserve and develops plans for its future employment (par. 67). As flank security requirements change during the attack, he adjusts security measures. Based upon recommendations of fire support unit leaders, he orders the displacement of weapons in general support so as to provide continuous support to the attacking platoons. He orders the displacement of the command post to keep it close enough to the attack echelon for effective control.

c. Strong enemy action may halt the advance in spite of the use of all available supporting fires and the commitment of the reserve. In such a situation, the company consolidates the ground already seized, continues to place fire on the enemy and notifies the battalion commander. No withdrawal is made except on orders of the battalion commander. Consistent with orders from the battalion commander, the company commander attempts to maneuver elements to strike the enemy flanks and rear. Every effort is made to overcome the resistance rapidly to permit resumption of the advance.

65. Movement From the Final Coordination Line to the Objective

a. The assault coordination line is the location on the ground at which the attacking echelon completes its deployment in preparation for conducting an assault. The point at which the FCL is located is determined by how close the attacking force can get to the objective without suffering unacceptable casualties from friendly supporting fires. Because of the dispersion characteristics of typical larger caliber fires, this is approximately 100-

150 meters. However, this distance may be reduced if terrain permits, or if the commander determines that fewer casualties will be suffered if the attacking echelon moves closer to the enemy positions under cover of supporting fires, as in the case of a well prepared defensive position.

b. If the commander has previously designated a tentative FCL, he determines whether or not the existing situation permits its use. If a tentative FCL has not been prescribed prior to commencing the attack, the commander will designate one at the earliest possible time in order that coordination may be made in preparing for the assault. He may do this by referring to previously designated checkpoints or phase lines or by specific reference to identifiable terrain features. When the tentative FCL is selected, or changed, both the attacking echelon and fire support units must be immediately notified.

c. As the attacking echelon approaches the assault coordination line, supporting fires on the enemy position increase in intensity. The attacking echelon completes its deployment so that as it crosses the FCL it will be in a formation to conduct an assault. In some situations the attacking troops may be halted so that deployment may be completed and all elements cross the FCL simultaneously. If such a halt is required, it will be accomplished short of the FCL so that supporting fires can continue on the enemy position.

d. When deployment is completed, the attacking echelon crosses the FCL. At this time supporting fires dangerous to the troops are lifted or shifted while others continue to fall on the enemy position. The attacking troops, together with direct fire supporting weapons, increase the intensity of their fires in order to maintain fire superiority over the enemy. This lifting or shifting of the supporting fires, normally controlled by the company commander, must be coordinated closely with the advance of the attacking troops. The commander is assisted in this by reports or signals from his platoon leaders and by his own observation of the attack. As the fires of direct fire weapons become masked by the attacking troops, they are shifted by the gunners.

e. The successful movement of the attacking echelon is largely dependent upon the effectiveness of the supporting fires. Normally, enemy resistance will dictate an advance by fire and movement, employing individual(s) squad rushes or creeping and crawling. In this case the enemy position(s) offering resistance must be singled out by platoon and squad leaders as individual objectives.

f. When the fires of the attacking echelons have eliminated or neutralized effective enemy fire, assault fire techniques are em-

ployed. This condition cannot be predetermined prior to crossing the FCL, but may occur at any time between the FCL and the enemy position. Riflemen move rapidly to close with the enemy, firing aimed or well-directed shots either from the shoulder or underarm position at locations in their zone of advance that could conceivably contain an enemy. When an enemy exposes himself or a definite target appears, the riflemen must fire an aimed shot. Regardless of whether the riflemen fire from the shoulder or underarm position, it will usually be necessary to pause momentarily in order to insure an aimed or well-directed shot. This phase of the assault is characterized by the volume and accuracy of fire and violence of action. It is designed to kill and demoralize the enemy, and keep him down in his hole until the riflemen can close with and kill or capture him. Squad automatic weapons are fired in short bursts, covering the squad front. Grenade launchers (M79), hand grenades, and flamethrowers may be used to overcome pockets of resistance, such as bunkers.

g. The assaulting troops having closed with the enemy, clear the enemy's positions and move over the objective far enough to place fire on any withdrawing elements and to protect against a counterattack.

h. Control of the assaulting elements of the company is exercised as follows:

- (1) The company commander locates himself where he can best influence the action. This may be with one of the assaulting platoons or at a vantage point.
- (2) In cases where more than one platoon is participating in the assault, a base platoon is designated. Platoons in turn designate base squads. All squads guide on the base squad; the base squad leader designates a base fire team within his squad. In other squads, the fire team closer to the base squad is designated as the base fire team.
- (3) Since the units must be prepared to protect against counterattack and/or to resume the attack after the objective is seized, all leaders insure that individuals do not "waste" ammunition during the assault by indiscriminate firing.
- (4) All leaders insure that a heavy volume of accurate fire covers the objective, and that the assault moves forward aggressively. As the noise and confusion of battle normally makes control by voice difficult, leaders often have to move to critical points of action where they can make certain their commands are understood and carried out. It is at this time that preplanned pyrotechnic signals may be decisive.

i. For a detailed discussion of conduct of the assault under varying conditions, see chapter 2, section II, FM 7-15.

66. Employment of the Weapons Platoon

a. General.

- (1) During the attack, the weapons platoon leader locates himself where he can assist the company commander. He may remain with or near the company commander or he may go where he can best observe the advance of the attacking platoons and control the employment and displacement of his subelements simultaneously. The platoon-sergeant performs such duties as the platoon leader directs. He normally accomplishes or supervises ammunition resupply. The rocket launcher organic to platoon headquarters is used to provide close-in antitank protection as directed by the platoon leader.
- (2) Throughout the attack, the weapons platoon leader makes recommendations to the company commander concerning the employment of the weapons. He recommends the method and time for displacement, changes in the method of employment of elements of the platoon as required by changes in the situation, and the best way to utilize the fires. He keeps the company commander informed of the status of ammunition supply, especially when hand-carry of mortar ammunition is involved.
- (3) During the attack, radio is the principal means of communication. It is supplemented by wire, messenger and other means whenever possible. The FDC is provided with an additional radio so that it can maintain continuous communication during displacement.
- (4) The weapons platoon leader specifies how ammunition will be resupplied to the squads, based on the company plan. A primary duty of the platoon sergeant is the supervision of this resupply. The company commander may use some of the platoon's $\frac{3}{4}$ -ton trucks and trailers to establish the company trains. Therefore, depending on the number of vehicles available to the platoon, a $\frac{3}{4}$ -ton truck and trailer or the $\frac{1}{4}$ -ton truck and trailer may be used to carry ammunition to the squads; a $\frac{3}{4}$ -ton trailer loaded with ammunition may be placed at the mortar position, to be replaced with a full trailer as it becomes empty; in exceptional cases, the antitank squads may secure ammunition directly from the company trains using their organic vehicles; the platoon may use carrying parties; or vehicles under company control may distribute

ammunition directly to the squads. Ammunition resupply as pertains to the weapons platoon, mechanized rifle company, is discussed in paragraph 37.

b. Antitank Squads.

- (1) *Control.* The antitank section leader may take his orders from either the company commander or the weapons platoon leader. If squads are attached to a rifle platoon, the squad leader takes orders from the rifle platoon leader. In a general support role, the antitank squads operate in the company command net.
- (2) *Targets.* The primary target for the antitank guided missile (ATGM) is enemy armor. If the antitank squad is firing in close support of a rifle platoon and an enemy tank appears, the squad leader immediately takes the enemy tank under fire. The squad may engage point targets such as crew-served weapons, small groups of enemy personnel, and bunkers or pillboxes in a close support role. To insure immediate availability of missiles for their primary role, the squads usually fire on definitely located point targets only.
- (3) *Selection of firing positions.* The antitank squads are normally employed individually. They are placed to cover likely enemy armor approaches into the company zone or along the axis of advance, or to permit close fire support for the attacking platoons, depending on their assigned mission. If possible, primary positions are selected which will permit the squads to provide both antitank protection and close fire support. Positions that permit flanking and oblique fires on enemy armor are desirable. It is also desirable that the positions provide partial defilade for both vehicle and crew. Enemy action may make it necessary to place the vehicle in complete defilade and use the ground guidance equipment. Alternate and supplementary positions are selected.
- (4) *Occupation of firing positions.* The antitank section moves from the assembly area or from previous firing positions and occupies new firing positions early enough to support the advance. The squad leader designates the exact position and also how the position is to be occupied. A route should be selected which permits the position to be occupied free from enemy observation. Positions that must be occupied under enemy observation are occupied at the last possible moment.
- (5) *Displacement.* The antitank squads displace on order or when they can no longer accomplish their assigned

mission from their initial positions. Since the ATGM may be launched from either the vehicle or ground, it is desirable that squads initially support the attack using the ground mount with additional weapons retained on the vehicle for displacement. Both squads may displace at the same time to support the lead elements of the company, or one of the squads displaces while the other may remain in position to provide antitank protection for the company flanks and rear. Displacement is made by vehicle over previously planned routes. The antitank section leader insures that he has a maximum load of ammunition on vehicles before starting his displacement.

c. 81-mm Mortar Section.

- (1) *General.* When the section is employed in general support, it normally fires from one centrally located position area with one fire direction center. When a mortar squad is attached to a rifle platoon, one forward observer, one radiotelephone operator, and one fire direction computer accompany it so that it can establish its own FDC. An attached squad normally relies on wire for communication between the observer and the mortar position.
- (2) *Targets.* The mortars generally engage area type targets. The most effective fire is observed fire, but during periods of poor visibility the FDC can place fire by computing data from maps or by adjusting from previously fired concentrations.
- (3) *Selection of firing position.* The information required for selecting the mortar position can be obtained from a map, a terrain reconnaissance and, for displacement, from information from FO parties accompanying the attacking platoons. The following factors should be considered:
 - (a) The mortar position is normally well forward in the attack to take advantage of the greater accuracy of the mortar at short ranges and to provide fires for as long as possible without displacing. Initial objectives should be within their effective close support range.
 - (b) The position should allow mortar coverage of all rifle platoon objectives and the key terrain features between and to the flanks of these objectives.
 - (c) The position should be in defilade and should give mask and overhead clearance that will allow the mortars to fire at minimum and maximum elevations.

- (d) Routes of supply should be short, covered, and concealed, and should permit vehicular movement into the firing position if possible.
 - (e) Alternate positions are selected. Movement to them is ordered by the platoon leader or, in his absence, the section leader, when enemy fire threatens the mortars and crews. Supplementary positions are also selected to permit coverage of areas which cannot be covered from primary or alternate positions. The company commander is notified when a move to alternate or supplementary positions is necessary.
 - (f) A position should allow adequate dispersion between mortars.
- (4) *Occupation of firing position.*
- (a) The mortar section moves from the assembly area or from previous position in time to occupy the new firing position and, if possible, register the mortars before the attack. The platoon leader may start the section moving before issuing his attack order; the determining factors are the distance involved and the time required for initial preparation of positions.
 - (b) The mortar section usually moves by vehicle to the new firing position. Upon occupation, vehicles are dispersed in a concealed and covered area nearby or released to company control, as appropriate (a(4) above). When the terrain and enemy action prevent vehicular movement, the mortars and ammunition must be hand-carried; the mortar squads cannot do this alone, so arrangements must be made to obtain assistance. The mortars are emplaced; the squad leaders are given initial firing data; one mortar is designated as base mortar and all other mortars are then laid parallel. Mask clearance is checked prior to firing. When the squads are ready to fire, the company commander and forward observers are notified.
- (5) *Forward observers (FO).* There are three forward observer parties in the mortar section, each consisting of an FO and a radiotelephone operator. These FO parties are positioned as directed by the company commander. One FO party is normally assigned to each of the attacking rifle platoons. One party may accompany the company commander or be assigned to the reserve. Before the attack, the FO establishes an observation post from which he can make an initial registration of planned fires. During the attack, the FO party remains

with or near the leader of the rifle platoon to which it is assigned.

- (6) *Fire direction center (FDC)*. When the section is employed in general support, the fire direction computers establish and operate an FDC at or near the mortar firing positions. It is normally close enough to the mortars to allow commands to be given by voice. Nevertheless, wire equipment is available for the establishment of a wire system between the FDC and the mortar position. The FDC receives fire requests, computes the data, and sends fire commands to the mortars. The platoon leader, section leader, or the senior fire direction computer decides the number of weapons to be used and the number of rounds to be fired for each request.
- (7) *Displacement*. Displacement is by vehicle when the terrain, enemy situation, and availability of vehicles will permit. There are three methods of displacing the section when it is employed in general support.
 - (a) *Three echelons*. This method is normally used when time is available, since it permits two squads to continually be in position, ready to fire. One squad displaces with enough men to establish a new FDC. The second squad does not begin displacement until the first squad reports that it is ready to fire. The third squad does not displace until the second squad is ready to fire.
 - (b) *Two echelons*. When displacement is begun while fire missions are numerous, only one squad displaces initially; when fire missions are few, two squads displace initially. In either case, enough men accompany the initial echelon to establish a new FDC. This method is faster than displacement by three echelons and still enables the mortars to provide continuous fire support.
 - (c) *One echelon*. This method involves the displacement of the entire section at one time. This is the least desirable method because it does not permit the mortars to provide continuous fire support.

67. Employment of the Company Reserve

a. The commander commits his reserve to insure accomplishment of the mission. He uses it to exploit an advantage gained by the attack echelon or to maintain the momentum of the attack. Preferably, he commits it against enemy weakness rather than against enemy strength.

b. When the reserve consists of more than one platoon, the

company commander commits only as much of the reserve as is required to accomplish a specific mission. He commits the entire reserve when necessary.

c. During the attack, the company commander keeps the reserve platoon leader(s) informed of plans for his anticipated employment.

d. When the commander commits his reserve, he immediately informs the battalion commander of the fact, and reconstitutes a reserve as soon as possible.

68. Reorganization and Consolidation

a. The company commander reports the seizure of the objective to the battalion commander. Consolidation starts as soon as the objective has been seized. Plans announced in the attack order are revised as necessary. If appropriate, the company commander prepares to continue to attack.

b. Reorganization is continuous throughout the attack. It includes the reassignment of personnel to key jobs made vacant by casualties, reestablishment of the chain of command, and redistribution of ammunition. During reorganization after seizure of the objective, the situation, strength, and ammunition status are reported to the battalion commander. Ammunition is brought forward and issued as required, and casualties are evacuated. Enemy information is reported and prisoners are sent to collecting points.

c. During the consolidation, organic and attached weapons are moved forward rapidly and integrated into the overall plan for the defense of the objective area. Possible routes of enemy counter-attack are covered by direct and indirect fires.

d. To prevent surprise, patrols operate to the front and flanks to maintain contact with the enemy and with adjacent units.

e. The company commander may use his reserve in the consolidation by positioning it to block an exposed flank or to extend the depth of the defense. The reserve may be employed temporarily forward of the objective to provide security during consolidation.

69. Continuation of the Attack

When the attack is to be continued beyond the initial objective, the halt on the initial objective is as short as possible consistent with orders from the battalion commander. Having previously made a tentative plan for continuing the attack, the company commander makes a reconnaissance and, using the information acquired on the reconnaissance, changes his tentative plan as necessary. His order for the continuation of the attack is normally fragmentary.

Section V. EMPLOYMENT OF ATTACHED TANKS

70. General

a. One or more tank platoons may be attached to the rifle company. Since a tank platoon generally operates more effectively as a unit, the rifle company commander normally employs an attached tank platoon as a unit under company control.

b. Aided by the recommendations of the tank platoon leader(s), the rifle company commander decides how the tanks and infantry will move in relationship to one another.

c. Mutual support and teamwork between tanks and infantry are essential. Infantry and armor leaders at all echelons closely coordinate their plans of action. The tanks assist the infantry by destroying enemy armor and weapons positions and by breaching lanes through barbed wire and antipersonnel minefields. The infantry assist the tanks by locating and destroying enemy tank-hunter teams and antitank gun positions, and breaching or locating routes through or around obstacles. During the conduct of the attack, tank commanders and infantrymen communicate with each other by radio, visual signals, personal contact, and the external interphone on the rear of the tank. The tanks and infantry must carefully coordinate the use of radio communications.

d. When available tanks should be utilized with infantry in the attack as a maneuver element, a fire support element, or a combination of both. (See also pars. 75-87.)

71. Dismounted Infantry and Tanks

Dismounted infantry and tanks may be employed on converging routes or on the same route. When employed on the same route the infantry and tanks move either at different speeds or at the same speed.

a. *Converging Routes.* Attached tanks may be employed with dismounted infantry by having tanks and infantry move on separate routes which converge on the objective (fig. 8). When this is done the tanks follow terrain most appropriate for employment of tanks and the infantry moves on terrain most appropriate to its employment. Usually the tanks will initially support the movement of the dismounted infantry by fire. The movement of the tanks will then be timed so that they assault the objective first, desirably, under time fire. This technique of the tanks assaulting slightly in advance of the infantry takes maximum advantage of the shock action of the tanks. Tanks and infantry may also assault at the same time. Careful planning is required to insure coordination of the assault phase of this attack.



Figure 8. Dismounted infantry and tanks attacking on two converging routes.

b. *Same Route.* Dismounted infantry and tanks may move on the same route as follows:

- (1) *Different speed.* When tanks and dismounted infantry attack together on the same route, the tanks may initially support the advance of the infantry by fire. As the infantry approaches the final coordination line, the company commander orders the tanks forward for the assault phase. If the defenses on the objective are hastily prepared and lack overhead cover, the movement of the tanks may be so timed that they pass through the infantry and assault the objective under artillery and mortar time fire, followed closely by the infantry assault. When positions on the objective cannot be neutralized by time fire, the movement of the tanks is so timed that they join the infantry at the final coordination line, and both infantry and tanks assault together. In either case, the movement of the tanks forward from their initial firing positions must be carefully timed to prevent either tanks or infantry from halting at the line.
- (2) *Same speed.* Dismounted infantry and tanks may advance together at the same speed (fig. 9) when they need close mutual support or when there are no positions from which the tanks can initially support by fire. The infantry may move slightly in advance of the tanks (being sure not to mask their fires), between them, or immediately in rear of them. As the advance progresses, the relative positions of tanks and infantry are adjusted according to enemy resistance and the terrain. This technique of movement permits close coordination and maximum mutual support, but sacrifices the speed of the tanks which makes them more vulnerable to antitank fires.

72. Tank Support by Fire Only

In some instances tanks will be able to support by fire only. This is the least desirable use of tanks (fig. 10) and should be employed only when conditions exist that prevent the tanks from reaching the assault line. Even though the shock action and some measure of the firepower of the tanks are lost, they may be used effectively. As soon as the tank obstacles are breached or a suitable avenue of approach is uncovered, the tanks should rejoin the attacking infantry as rapidly as possible. Conditions dictating the use of this method are present when—

- a. Obstacles exist short of the objective which the tanks cannot bypass and when reduction would delay seizing the objective.
- b. Terrain must be seized which is impassable to tanks.

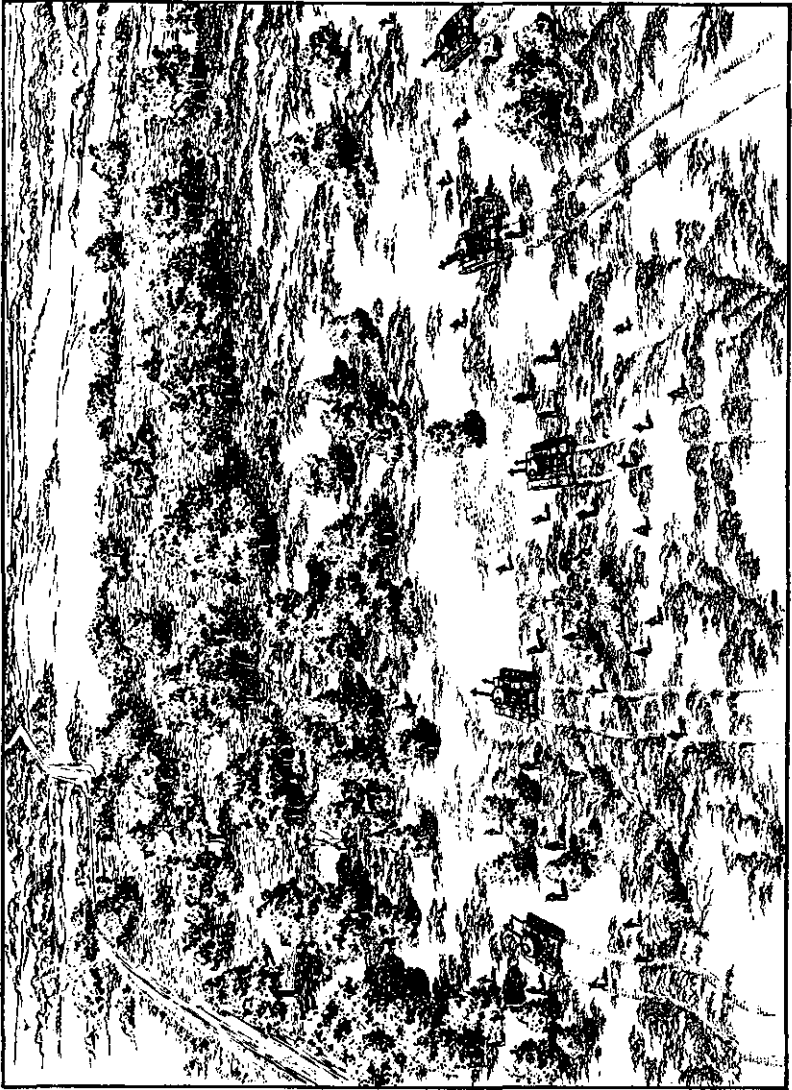

Figure 9. Dismounted infantry and tanks attacking together.



Figure 10. Tanks support by fire only.

73. Infantry Riding Tanks

When tanks and infantry must advance rapidly and no personnel carriers are available, infantrymen may ride on the tank decks. This technique is effective when trying to regain contact with the enemy; when exploiting the effects of nuclear weapons; or when the terrain and the enemy situation indicate that fewer casualties will result from rapid movement than from a dismounted advance. However, infantrymen mounted on tanks are extremely vulnerable to all types of fire, and they reduce the maneuverability and fire-power of the tanks. The infantrymen must dismount as soon as they come under effective small arms artillery or antitank fire, or when dismounted infantry action is required.

74. Reorganization and Consolidation

In completing the assault, the tanks move aggressively through the depth of the objective and take up hull defilade positions where they can cover likely enemy armor approaches and aid the infantry in repelling counterattacks. During the hours of darkness it may be necessary to withdraw the tanks to locations within the organized positions. The company attack order designates tentative position areas for the tanks during the consolidation. The tanks are resupplied as required either on the position or in a covered area immediately to their rear. If enemy fire prevents resupply of the tanks on position, they move to the rear individually or by section to accomplish resupply and then return. Crews perform maintenance as the situation permits.

Section VI. MECHANIZED INFANTRY RIFLE COMPANY IN ATTACK

75. General

a. The mechanized infantry rifle company is the basic rifle company organization discussed in this section. To a degree, the procedures outlined will pertain to infantry or airborne infantry rifle companies in relation to—

- (1) Attachment of nonorganic APC.
- (2) Augmentation of maintenance and supply facilities.
- (3) State of training of the company.

b. Mechanized operations are the normal operations for the mechanized rifle company. Other types of rifle companies are mechanized when conducting fluid operations, where rapid movement over great distances is required. Such operations include attacks against light or discontinuous enemy resistance and the exploitation of the success of other units or the effects of nuclear weapons. For a discussion of the rifle company as part of a bat-

talion in a mechanized attack, see FM 7-20. For a discussion of the rifle platoon in mechanized operations, see FM 7-15.

c. In the attack, the mechanized rifle company has all the rifle platoons and the mortar squads mounted in APC. The APC is designed to increase the battlefield mobility of the company and afford it a degree of armor protection. However, the APC is not an assault vehicle and should not be used as such. In planning the attack, the company commander must make every effort to capitalize on the mobility of the APC while at the same time reducing its exposure to enemy antitank fire. Care must be taken to insure that the APC is not used as a tank. For a discussion of the characteristics, capabilities, and limitations of APC, see FM 55-37.

d. The techniques in planning and the techniques and tactics for conducting the attack described in paragraphs 50 through 74 and 88 through 105 generally apply to a mechanized attack.

e. For purposes of discussion in this section, a mechanized attack is one in which attacking rifle platoons are mounted in APC for any part of their movement forward of the LD.

76. Terrain Considerations

Tracked vehicles operate most effectively over rolling terrain, where their cross-country mobility may be used to the best advantage. In close terrain, such as woods, infantry may have to dismount to provide protection against enemy tank-hunter teams. Terrain obstacles are considered not only with respect to tracked vehicles, but to wheeled vehicles that carry supporting weapons, as well.

77. Enemy Considerations

Enemy defenses have a considerable effect on the selection of routes and on the ability to move mounted in the attack. Enemy armor, antitank defenses, emplacements having overhead cover, and artificial obstacles are particularly important. Airburst artillery and mortar fires are ineffective against personnel with overhead cover, so mounted movement in proximity to covered positions is not normally practicable. Enemy armor, antitank defenses, and obstacles may preclude or greatly restrict mounted movement forward of the LD until they are destroyed or neutralized by dismounted action or other means. Against hastily prepared positions with weak antitank defenses, mounted movement may be practicable all the way to the objective.

78. Control

a. *General.* The attack is controlled primarily by radio and visual means, augmented as necessary by motor messenger. Each

APC is equipped with a radio set. Unit standing operating procedure may contain detailed instructions on the use of visual signals, including arm and hand signals, flag signals, panels, pyrotechnics, smoke grenades, and smoke streamers.

b. Control Measures.

- (1) In a mechanized attack, units normally occupy the attack position for the shortest possible time; preferably units move through the attack position deployed in combat formations without halting.
- (2) The company is normally assigned an axis of advance or, less frequently, a zone of action. A mechanized rifle company is rarely required to clear a zone. The company commander may assign axes of advance or zones of action to his attacking platoons. Zones should be wide enough to permit maneuver. To facilitate a rapid advance, platoons should not be required to clear their zones unless the company zone must be cleared.
- (3) The main advantage of a mechanized attack is the capability of advancing steadily and rapidly. Since the use of intermediate objectives tends to slow an attack, they are designated less frequently for a mechanized attack than for a dismounted attack. Checkpoints and phase lines are particularly useful when it is likely that fire support elements will not be able to keep up with the attack echelon. The need for the close and continuous support of these elements must be weighed carefully against the advantages which might result from the rapid, uninterrupted advance of the attack echelon.
- (4) The company commander normally selects a dismount area(s) forward of the LD, where his attack echelon dismounts from its APC. The dismount area may be short of the final coordination line, at the final coordination line, or on the objective. It should be concealed and covered if possible, and it should be as far forward as the terrain and the enemy situation permit. In selecting the dismount area, the company commander estimates how far forward his attack echelon can move mounted before becoming vulnerable to enemy tanks, antitank guns, obstacles, or tank-hunter teams. He also considers the protection afforded by attached tanks, supporting fires (including time fire over the advancing carriers), and the terrain, and the effects of nuclear weapons on enemy defensive positions. The dismount area selected during the planning stage of the attack is only a *tentative* location and it may be changed during the

attack as required by the situation. Normally, the dismount area is located on the objective only when tanks are attached to the company and when enemy strength is effectively neutralized by fire.

- (5) The company commander selects the final coordination line even though it may be practicable for his mounted force to move straight onto the objective, because enemy action may force his troops to dismount earlier than intended.

79. Mechanized Infantry and Tanks

(See also pars. 70-74.)

a. The attachment of tanks has a pronounced effect on the attack of the company. When operating without tanks, the ability of the company to move forward of the LD mounted is curtailed because of the vulnerability of the APC to enemy fires. A mechanized attack without tanks is feasible when the enemy defenses have been so devastated (as by nuclear fires) that the possibility of effective enemy reaction is remote. When tanks are attached, they provide protection for the APC by destroying enemy tanks and antitank weapons. In addition, they divert fire which otherwise might be directed at the APC. The tanks are usually employed in the attack echelon as the lead element. For further details on the employment of tanks and mechanized infantry, see FM 7-20.

b. In a mechanized attack, infantry and tanks may both advance simultaneously (each in an appropriate formation) (fig. 11) or the infantry may follow the tanks by bounds (fig. 12). The tanks lead so as to best utilize their firepower. The mechanized infantry follows to the rear of the tanks so as not to unduly expose the APC. The method used for a given attack is dependent upon the commander's estimate of the situation rather than upon an arbitrary decision that one of the methods is better for all situations. Normally tanks and mechanized infantry will be employed in mass against enemy positions not strong in antitank defenses. Regardless of the type formation adopted, the distance between tanks and APC must not become great enough to let enemy forces into the gap, thereby separating the tank and infantry units; also it must not be so great as to deny the tanks rapid infantry support when needed. In determining the position of the APC in relation to his tanks, the commander must continuously evaluate the relative importance of the availability of the mounted infantry and their vulnerability to enemy fire.

c. In some situations, it may be necessary or desirable for mechanized infantry and tanks to move on separate routes. This

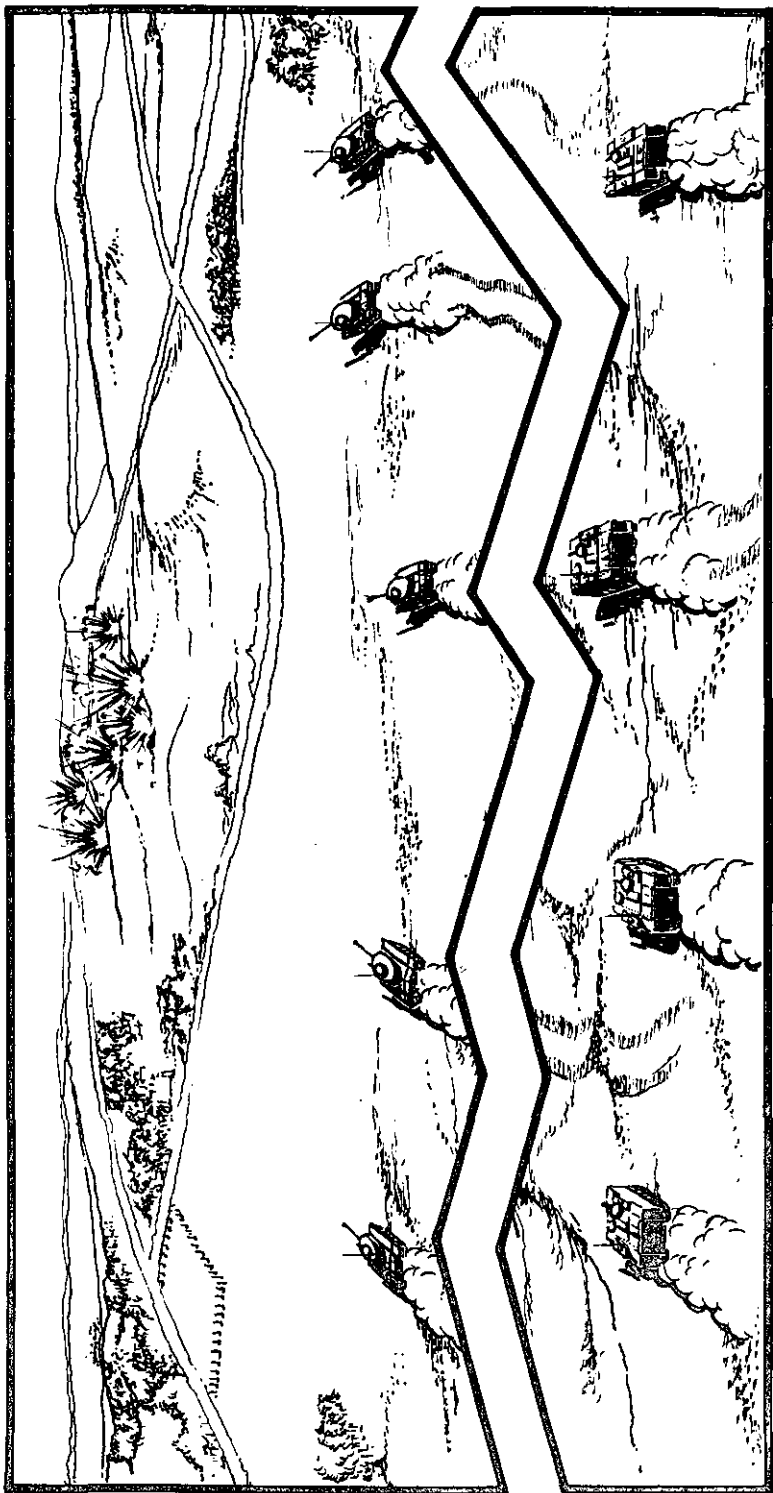

Figure 11. Mounted infantry and tanks both advancing in line formations.

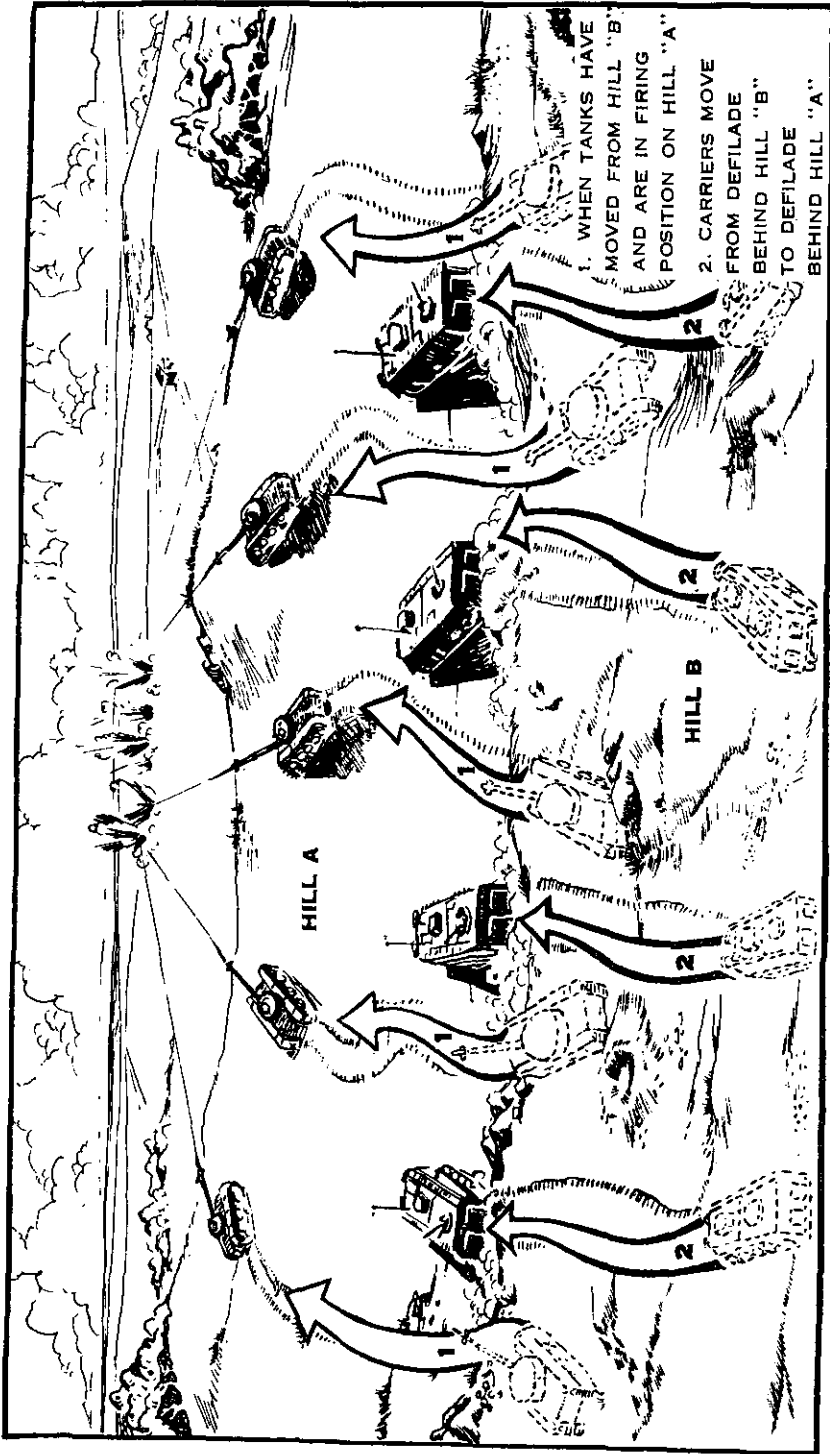

Figure 12. Mounted infantry following tanks by bounds.

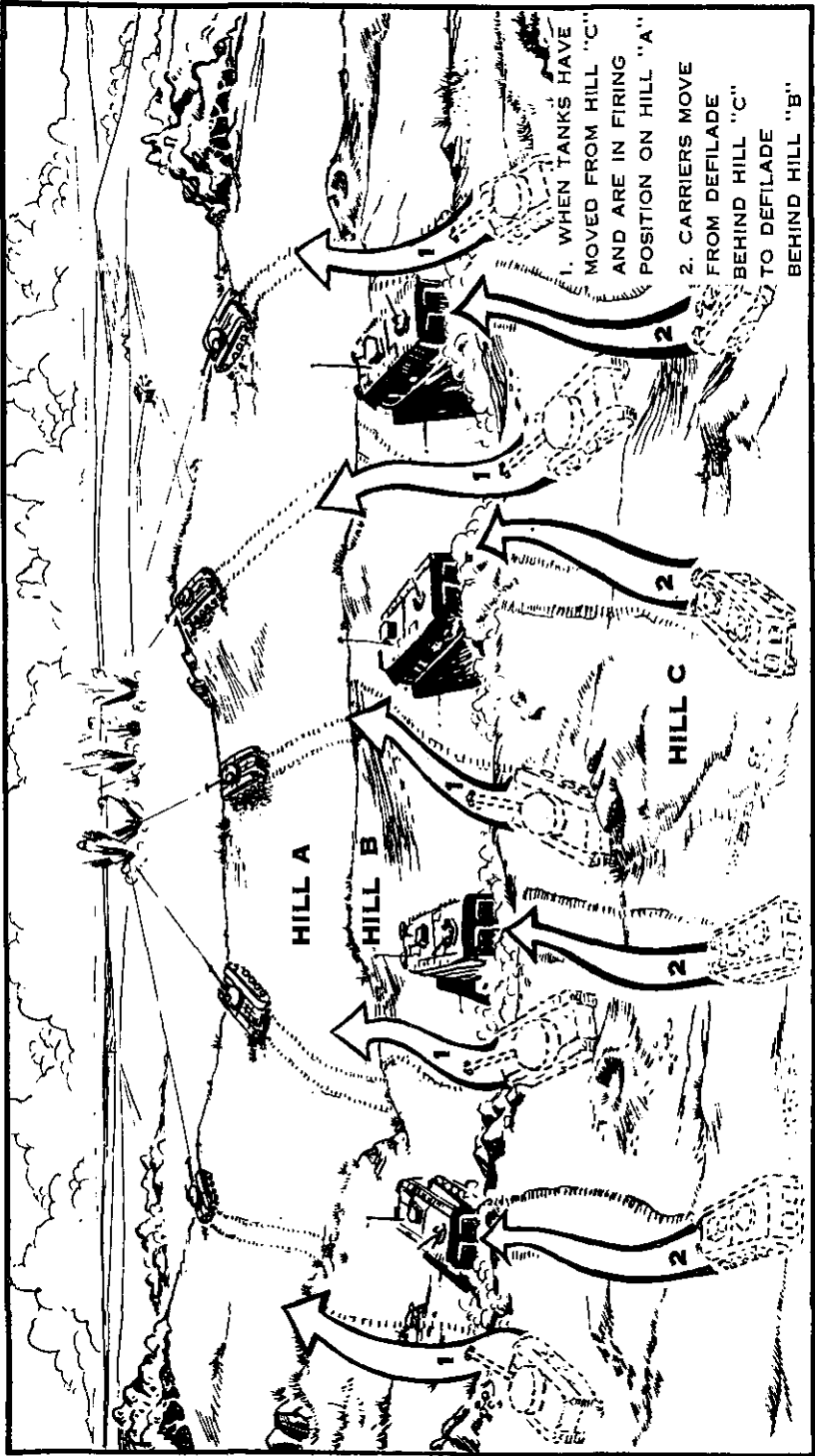

Figure 12—Continued.

will be the case when the amphibious capability of the APC is exploited. In such situations, the tanks support the attack by fire and join the infantry as soon as practicable. Once the infantry and tanks are reunited, the attack continues as described in paragraph 79a. It is emphasized that separation of the APC from the tanks increases the danger to the APC from enemy fires. For this reason, APC and tanks use separate routes only when forced to do so. (As an exception, see par. 80.)

d. The mobility and armor protection of the APC must be utilized to the utmost. The mechanized infantry should remain mounted as long as possible so that—

- (1) The attacking force can move forward at the speed of the tanks and APC in order to rapidly close with and destroy the enemy.
- (2) The battlefield mobility of tanks and mechanized infantry will be retained.
- (3) Casualties will be minimized in areas swept by small arms and artillery fire.
- (4) Artillery airbursts can be employed in support of the attacking forces.
- (5) A degree of protection will be afforded against the effects of nuclear weapons.
- (6) The energy of the infantry will be conserved so that it will be better able to fight when needed.

e. Mechanized infantry dismounts when it is necessary for it to—

- (1) Prevent its destruction by enemy antitank fire.
- (2) Assault a defended objective.
- (3) Breach or remove obstacles which prevent the forward movement of the tanks.
- (4) Assist in the neutralization or destruction of antitank weapons which are holding up the forward movement of the tanks and APC.
- (5) Lead an attack through heavily wooded areas or very rough or broken terrain.
- (6) Lead an attack across defended rivers which cannot be crossed by APC.
- (7) Attack through fortified areas or through defended towns and villages which cannot be bypassed.
- (8) Assist the tanks forward under certain conditions of low visibility and restricted fields of fire (darkness, smoke, heavy woods, broken terrain, etc.).
- (9) Mop up an objective and assist in the consolidation.

f. Mutual support between mechanized infantry and tanks is continuous. All leaders study, plan, and prepare ways of coordinat-

ing and supporting tactical elements to meet changing battlefield conditions.

(1) The role of mechanized infantry in support of tanks is to:

- (a) Breach or remove antitank obstacles.
- (b) Assist in the neutralization or destruction of antitank weapons.
- (c) Designate targets for the tank.
- (d) Protect the tanks against individual antitank measures.
- (e) Lead the attack dismounted when necessary.
- (f) Provide security for tanks.
- (g) Mop up and assist in consolidation of the objective.
- (h) Protect the tanks in assembly areas and attack positions.

(2) The role of tanks in support of the mechanized infantry is to:

- (a) Lead the attack.
- (b) Neutralize or destroy hostile weapons by fire and maneuver.
- (c) Clear paths for dismounted infantry through wire and antipersonnel minefields.
- (d) Neutralize fortified installations with direct fire.
- (e) Support by direct fire when dismounted infantry lead the attack.
- (f) Provide antitank protection.

g. In the conduct of the attack with tanks, the ideal to be achieved is to have the arrival of the infantry and the tanks at the objective so timed as to attain the maximum effects of the shock action and firepower in the combined arms team.

80. Employment of Armored Personnel Carriers When They Are Not Organic

a. When enough APC are attached to the company to mechanize all the rifle platoons, the company commander normally further attaches four APC to each. When additional APC are available, he retains one as his command vehicle and attaches others to the weapons platoon for use by the mortar section.

b. If the commander has only enough APC to mechanize a portion of the company, he must determine how he can best use them to accomplish his mission. Based on the situation and his plan of attack, he may attach them to the reserve platoon(s) or the attacking platoons. A mechanized reserve provides flexibility in that it can be moved rapidly to influence the action. If only the attacking platoons can be mechanized, the commander must consider the problem that may arise if the reserve cannot keep up with them.

c. The platoon leader normally attaches one of his four APC to each of his squads. The squad leader commands the APC and, under the supervision of the platoon leader, is responsible for its positioning, movement, camouflage, and all other aspects of its employment. The platoon leader and platoon sergeant ride in separate APC and command the APC they ride in, but only while they are mounted.

81. Formations

The considerations involved in selecting a company attack formation are basically the same, whether the company is mechanized or dismounted.

a. A column formation is used more frequently for a mechanized attack than for a dismounted attack, because the mechanized rifle company generally attacks to seize deep objectives and the enemy situation is often obscure. Within the column, elements are located in the order of anticipated commitment, with tanks normally leading.

b. The number of tank platoons attached to the company may affect the company commander's decision in selecting a formation for a mechanized attack.

c. For more information on mechanized infantry rifle platoon formations, see FM 7-15.

82. Plan for Use of the Reserve

The mobility of the mechanized reserve allows the company commander flexibility in planning for its use in view of the reduced reaction time required. For example, it may be able to provide flank security and maintain contact with adjacent units, while retaining the capability of maneuvering rapidly to influence the action of the attack echelon. Positioning the reserve near an exposed flank or near the area of anticipated commitment may not be required as with a dismounted reserve, thus permitting greater dispersion within the company. The plan of attack may call for the reserve to move by bounds or, when an attack echelon is expected to advance rapidly, the reserve may be ordered to follow it at a specified distance.

83. Security

Since the reserve can move rapidly to meet an enemy threat on a flank, primary consideration is given to providing early warning. Mechanized or airmobile flank patrols may be used for this purpose. They move by bounds from one dominant terrain feature to the next as the attack progresses. In determining the number of squads to be used as flank patrols, the company commander con-

siders the effects of thus depleting the reserve. Observation in the area may provide adequate security without the use of patrols.

84. Fire Support Planning

a. Since the movement of mechanized maneuver elements is rapid, detailed planning and coordination of supporting fires are essential to permit the timely delivery, shifting, and lifting of fires. Flexibility of fires to meet unforeseen situations is mandatory.

b. Maximum consideration is given to the use of supporting fires to protect the movement of tanks and APC. Emphasis is placed on the neutralization of known or suspected enemy anti-tank weapons. Smoke may be used to screen the forward movement and the dismounting of the infantry in the dismount area. Artillery and mortar fires, using airbursts, may be used effectively to provide protection from antitank weapons when the enemy does not have the protection of overhead cover.

c. When the company commander plans the employment of fires of the weapons platoon, he also plans the displacement of the weapons in relation to the movement of his maneuver elements. He plans for the exclusive use of nonorganic fires during periods when continuous fire support cannot be provided by these organic means, as during a very rapid advance. He normally uses the anti-tank squads in general support, and he may have them provide antitank protection to the company flanks while tanks protect the front. For nuclear fire planning and employment of Davy Crockett, see paragraphs 60 and 61 and FM 7-20.

85. Conduct of the Attack

a. Movement forward and across the LD is continuous, with deployment into the initial company and platoon attack formations being accomplished on the move if possible. If a halt in the attack position is necessary, it should be as short as possible.

b. The movement from the attack position to the line of departure is in a deployed formation that permits maximum use of concealment and cover. This formation will place the maneuver elements on the line of departure in the relative position from which they will start the attack.

c. Movement forward of the LD is made as rapidly as the terrain, speed of the vehicle, and use of supporting fires permit. During the forward movement, the .50 caliber machineguns on the APC may fire at known or suspected enemy positions. Tanks and APC of the attack echelon advance as described in paragraph 79.

d. During the advance, the infantry dismounts rapidly for action when the situation requires. When any part of the movement forward of the LD must be made through close terrain, such as woods, infantry must dismount to provide the necessary close-in security for the APC and tanks. The APC and tanks then adapt their speed to that of the dismounted infantry. When the close terrain has been crossed, the men on foot remount, and the advance is continued.

e. The attacking units advance mounted as far forward as possible. Upon reaching the dismount area, the vehicles halt under available cover, and the infantry rapidly dismounts. Maximum fires, including smoke, are placed on enemy positions at this time. When practicable, the APC occupy suitable firing positions (preferably in hull defilade), and the fires of the .50 caliber machine-guns (manned by the driver) support the dismounted advance of the infantry. The attack continues dismounted as described in paragraphs 65 through 69.

f. When the dismount area is on the objective, APC and tanks move rapidly to that area (with hatches closed) under artillery and mortar fires using airbursts. When they reach the dismount area, supporting fires are shifted or lifted, and the infantry dismounts immediately to eliminate any enemy remaining on the objective. The exact timing of the shifting of fires is of great importance. The last rounds of the concentration may be colored smoke to indicate when the infantrymen inside the APC are to dismount.

g. In the attack using tanks and infantry, unless proper coordination is effected, the following undesirable situations may develop:

- (1) Tanks and infantry become unduly separated thereby allowing the enemy to destroy the dismounted infantry, and attack the unsupported tanks at close ranges.
- (2) Tanks cruise the objective thereby becoming needlessly exposed to enemy fires.
- (3) APC are left in exposed positions when the infantry dismounts with the result that needless losses occur from enemy antitank or other fires.
- (4) Personnel may remain mounted too long exposing both the APC and infantry to destruction by enemy short range weapons.

h. If the APC receive effective tank or antitank fire before they reach the dismount area, the platoon leader must determine *immediately* what steps he must take prior to dismounting the infantry. Often his best course of action is a continued rapid movement if cover is available a relatively short distance forward,

especially if artillery and small arms fires are falling around the APC. If the APC are on the crest of a hill when fired upon, it may be feasible for them to back into defilade, though halting the vehicles turn them into stationary targets. If they are in the open when fired upon and no cover is available for a great distance, the platoon leader may be forced to halt his APC and dismount his platoon. Continued forward movement of the vehicles in this situation would probably risk their destruction. Regardless of the circumstances, all available supporting fires, including those of the APC mounted machineguns, are directed at the known or suspected source of enemy fire. The company commander, forward observers, and leaders of fire support units must be constantly alert for such an occurrence and must react without hesitation to neutralize the enemy's fire. Smoke or white phosphorus rounds fired immediately into the enemy position by direct fire weapons will screen the mechanized platoon in moving to cover and/or dismounting. Upon dismounting, the infantry continues the attack.

i. The company commander normally follows closely behind the attacking platoons to keep abreast of their progress and the situation as a whole. He closely coordinates the movement of his platoons and the fires of supporting weapons. He insures that FO's (mortar and artillery) maintain close and continuous liaison with him. He takes particular care to insure the timely and rapid displacement of organic and attached supporting weapons to provide continuous fire support and antitank protection. He may have to halt his attacking platoons on intermediate objectives until his weapons are in position. In some situations, he may decide to maintain the rapid rate of advance, placing complete reliance upon the fire support provided by higher headquarters, rather than delay his attacking echelon until his organic and attached weapons can displace.

j. Because of the fluid nature of mechanized operations, situations may change rapidly. Flexibility on the part of all leaders is essential, and reliance is placed on fragmentary orders at all echelons.

k. After seizing the objective, the attacking force reorganizes, consolidates, and disperses in much the same way as in a dismounted attack. (See also pars. 70-74.)

- (1) APC will be brought forward to rejoin their units. Any one of several techniques may be employed: radio, messenger, or pyrotechnic devices. In some situations (limited visibility, lack of effective enemy antitank fires, etc.), APC may follow the dismounted infantry, keeping the last man in sight. This latter technique has the ad-

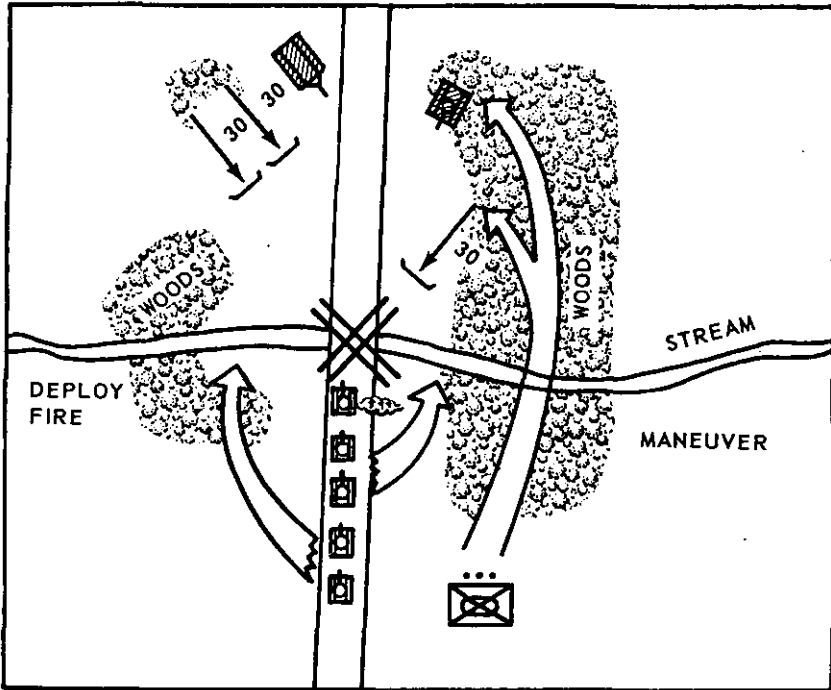

Figure 13. Attack from a march column to reduce a roadblock (schematic).

vantage of keeping the APC close to its unit with little time lost in remounting; however, it may result in the loss of APC if the unit becomes involved in a fire fight. The method used must be coordinated with the APC driver before the infantry dismounts.

- (2) In the consolidation, the APC occupy hull defilade positions so they can provide fire support, if this does not unduly expose them to enemy antitank fires. Otherwise, they should be placed in a covered position as close by as possible. Some of the APC may be positioned to provide security to the flanks and rear.
- (3) The APC are resupplied on position if possible, or in a covered area immediately behind the position.

86. Attack From the March Column

The attack from the march column differs from the coordinated attack in that there is not time for detailed reconnaissance and planning. Instead, the lead elements must attack swiftly and in mass. For speed and to keep the initiative, elements are placed in the column in the order of expected employment (figs. 13 and 14).

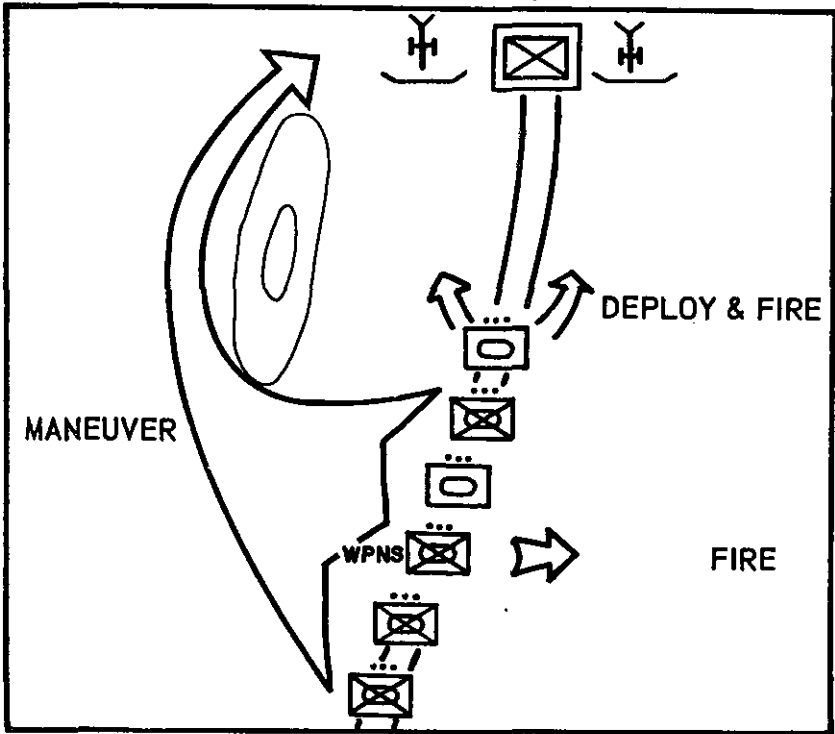

Figure 14. Company task force attack from march column against heavy resistance (schematic).

87. Pursuit

a. The mechanized rifle company normally conducts the pursuit as a part of a larger unit. The pursuit starts when the enemy cannot maintain his position and tries to escape or retreat. Pursuit begins only upon the order of a higher commander. Once begun, it is characterized by boldness and rapidity of action and is pushed to the limit of endurance. It is continued day and night. A company level, security measures are limited in the interest of speeding the advance. No opportunity is given the enemy to reorganize his forces.

b. To conserve the strength of troops and to provide speed, maximum use is made of all available transportation to overtake, envelop, and destroy the enemy. The company may be preceded by reconnaissance elements which have the mission of finding the enemy so that pursuing rifle elements can engage him.

c. The battalion commander allows the company commander maximum freedom of action. His orders usually are brief and fragmentary, giving objectives, an axis of advance, or a zone of action. Objectives are generally distant and may include such

terrain features as high ground, important road junctions, stream crossings, and defiles.

Section VII. RIFLE COMPANY IN A RESERVE ROLE

88. General

a. Mission. The rifle company, as all or part of the battalion reserve, is employed on one or more of the following missions:

- (1) An attack to exploit an enemy weakness.
- (2) An attack from a new direction on an enemy position which, because of its strength, has halted or threatens to halt the advance of the attacking echelon.
- (3) An operation against the hostile rear area to extend an envelopment or exploit a successful envelopment.
- (4) The assumption of the mission of an attacking element that has become disorganized, depleted, or for any reason has been rendered ineffective.
- (5) The reduction of enemy resistance that may have been bypassed by the attacking echelon or that may subsequently develop to the rear of the attacking echelon.
- (6) The protection of the battalion's flanks and rear.
- (7) The maintenance of contact with adjacent units.
- (8) The assistance of adjacent units when such action favors the accomplishment of the battalion mission.
- (9) Support of the attack with the fire of its crew-served weapons.

b. Movement. The battalion order prescribes the initial location of the company. The company moves to subsequent locations on order of the battalion commander. In a mechanized attack the battalion commander normally prescribes a route for movement of the reserve, using march objectives and phase lines for control and coordination.

c. Planning. Since the battalion order may include more than one contingent mission for the company, several plans may be required to comply with the order. These plans are as complete and detailed as circumstances permit. Fire support plans for the various schemes of maneuver normally include only on-call fires initially. Subordinate leaders are thoroughly informed of all plans so they can execute them promptly.

89. Conduct of the Attack

a. During the attack, the battalion commander may require the reserve company commander (or his representative) to accompany him until the reserve is committed. He may require the company commander to make recommendations on subsequent reserve loca-

tions or to otherwise assist in the preparation of plans for the employment of the company.

b. The company commander must keep himself informed of the situation at all times so he can execute an assigned mission promptly. He aggressively seeks information by maintaining close contact with the battalion commander, by monitoring transmissions over the battalion command net, and by reconnoitering. Based upon changes in the situation, he anticipates missions which are likely to be assigned to the company and prepares plans accordingly. He keeps his subordinates informed of the situation and the plans.

c. The battalion order committing the reserve is normally fragmentary and may or may not be according to a previously prepared plan. Similarly, the company commander's order is normally fragmentary, as time usually does not permit detailed planning or the issuance of lengthy orders.

d. When committed, the reserve is automatically relieved of any security or contact responsibilities contained in the initial battalion attack order, unless such responsibilities are specifically directed in the new order.

e. The conduct of the attack, reorganization, consolidation, and dispersal of the reserve company are carried out as discussed in paragraphs 62 through 87.

Section VIII. NIGHT ATTACK

90. General

a. *Purpose.* A night attack may be made to gain surprise, to maintain pressure or to exploit a success in continuation of daylight operations, to seize terrain for subsequent operations, or to avoid heavy losses by using the concealment afforded by the darkness. Night attacks are a normal part of operations and become increasingly important as enemy firepower increases.

b. *Orders.* Although the plan for a night attack should be as simple as possible, the attack order will normally be lengthy and detailed because of the unusual number of specific control measures and special instructions which are necessary. In conjunction with the order, a thorough terrain orientation is of the utmost importance.

c. *Characteristics.*

- (1) Night combat generally is characterized by a decrease in the ability to place aimed fire on the enemy; a corresponding increase in the importance of close combat, volume of fire, and the fires of fixed weapons which are laid on definite targets or target areas by daylight; difficulty

in movement; and the maintenance of control, direction, and contact. Despite these difficulties, the night attack gives the attacker a psychological advantage in that it magnifies the defender's doubts, apprehensions, and fear of the unknown.

- (2) The difficulties of night attack are reduced by adequate planning and preparation and by thorough training in the night operations. Normally, more time is required to plan and coordinate a night attack than a daylight attack. Thorough ground and/or air reconnaissance by leaders at all echelons is highly desirable. Because of difficulties in control, the scheme of maneuver is usually simple.

d. Techniques.

- (1) A night attack may be conducted by stealth, by using daylight techniques, or a combination of the two. In an attack by stealth, an attempt is made to maintain secrecy and achieve surprise in closing with the enemy before he discovers the attack. The particular technique employed depends on such factors as the enemy strength and degree of preparation of his positions, his security measures, the terrain, and light conditions. The situation may permit an attack by stealth to seize the initial objective, with the continuation of the attack being made using daylight techniques. Other situations may require daylight techniques for the entire attack. In any event, every effort is made to achieve the maximum degree of surprise, regardless of the techniques used.
- (2) This section deals primarily with techniques used in an attack by stealth. Certain of these techniques may be applicable even though the attack is made generally like a daylight attack.

91. Reconnaissance

If possible, all leaders reconnoiter during daylight, dusk, and darkness. Reconnoitering during different conditions of light assures maximum familiarity with the terrain. The company commander normally limits the size of reconnaissance parties and prescribes other limitations on reconnaissance essential to the maintenance of secrecy. Infrared or other night vision devices may be used to assist in reconnaissance and to detect the enemy's use of such equipment.

92. Surprise and Secrecy

Positive measures are taken to insure secrecy and increase surprise. In addition to the limitations on reconnaissance parties, the movement of vehicles and weapons is held to a minimum. Light

and noise discipline is rigidly enforced. Registration of weapons is avoided or accomplished in a way which will not indicate our intentions to the enemy. Significant change in any type of activity is avoided.

93. Control Measures

The degree of visibility determines the measures taken to assure control. Because visibility is often poor, the limited ability to control maneuver normally requires the company to move generally in a straight line over open terrain toward its objective. Terrain features used as control measures, if not easily identifiable at night, may be marked by artificial means. Control measures which are emphasized in a night attack are—

a. Assembly Area. The assembly area is normally assigned by the battalion commander. It may be closer to the line of departure than for a daylight attack.

b. Release Points. These are points at which a higher commander releases control of a unit to its commander. Company release points are designated by the battalion commander. The platoon release point is designated by the company commander, and the squad release point is designated by the platoon leader. Platoon and squad release points are located to provide a gradual deployment during movement to the probable line of deployment. They should be located far enough back to allow attack units to complete their lateral movement before reaching the probable line of deployment, yet far enough forward to permit centralized control as long as possible.

c. Attack Position. An attack position is normally used in a night attack. It is often designated by the battalion commander, or he may delegate its selection to the company commander. The attack position should be in defilade but need not offer as much concealment as in daylight; it should be easy to move into and out of.

d. Point(s) and Line of Departure. The company commander normally selects a point(s) of departure. It is a point(s) on the ground where the company will cross the prescribed line of departure.

e. Routes. The company commander selects the route the company will use from the company release point to the platoon release point. The platoon leader selects the route from the platoon release point to the squad release point. Normally this selection is made on the basis of observation of the area from a position to the rear of the line of departure. The route from the platoon release point to the squad release point is usually announced as a direction. The routes from the squad release point to the probable line of deployment are also announced as directions for squad movement. Guides

are normally used to assist in the movement to the probable line of deployment.

f. Probable Line of Deployment (PLD). This is the location on the ground where the company commander plans to complete final deployment prior to moving out with squads in squad line. The probable line of deployment should coincide with some visible terrain features to assist in its identification at night. It should be generally perpendicular to the direction of the attack and as close to known enemy positions on the objective as it is estimated the company can move without being detected. If the enemy has wire obstacles in front of his position, the probable line of deployment should be on the enemy side of the obstacle, if feasible. The company commander selects the probable line of deployment if the battalion commander does not do so.

g. Zones of Action and Objectives. The company is normally assigned a zone of action and, in addition, may be assigned a direction or azimuth of attack. The company objective is usually smaller than for a daylight attack so that the company can clear it in a single assault. The company commander usually assigns platoon zones of action by designating a portion of the probable line of deployment and an objective for each platoon. Platoon objectives should be small enough to be seized and cleared in a single assault. Assigned objectives should be designated by unmistakable terrain features. Intermediate objectives are not normally assigned.

h. Phase Line. A phase line is frequently designated to limit the advance of attacking elements. It should be easily recognizable in the dark (a stream, road, edge of woods, etc.) and far enough beyond the objective to allow security elements room to operate. The phase line is frequently prescribed by the battalion commander; if not, the company commander selects it.

i. Time of Attack. Often, an attack is made late at night so that initial objectives can be seized by daylight and the attack continued at that time. If the objective is relatively deep, or if the company mission requires immediate continuation of the attack, the attack may begin early at night and continue to the final objective during darkness. If the objective is to be seized and held, it also may begin early at night.

j. Other Measures. Additional measures which may be used to facilitate control include—

- (1) Use of an azimuth, mortar or artillery marking rounds, or tracers to assist in maintaining direction.
- (2) Use of guides and connecting files.
- (3) Designation of a base element on which other units base their movement.

- (4) Use of radar, infrared equipment, flashlights with colored filters or other night vision devices.
- (5) Prescribing intervals and distances to be maintained between individuals, squads, and platoons.
- (6) Identification of leaders and friendly troops by use of luminous buttons or tape, white armbands, etc.

k. Communication. The use of radio is normally restricted until after the attack is discovered. The company commander may use wire and/or messengers for communication with his platoon leaders. Pyrotechnics may be used as emergency signals, but their indiscriminate use may alert the enemy.

94. Formation

a. To assist in control, the column formation is used as far forward as practicable. If possible, deployment of the rifle squads in squad line is delayed until the company is within assaulting distance of the enemy positions. The principal considerations in the selection of a formation are visibility, distance to the objective, and anticipated enemy reaction. Based upon these considerations, the company normally crosses the line of departure either in a column of platoon columns or in a line of platoon columns. Generally, the single file formation is avoided.

- (1) If visibility is poor, distance to the objective is great, or early contact with the enemy is not expected, the company may cross the line of departure in a column (fig. 15). This formation is retained until the platoon release point is reached or unless enemy action forces earlier deployment.
- (2) If visibility permits control of a more open formation, the distance to the objective is short, or early contact with the enemy is expected, it may be desirable to advance from the line of departure in a company line of platoon columns (fig. 16).
- (3) If the company is in contact with the enemy and the distance to the objective is short, it will be necessary to have the leading squads move forward from their positions in squad line. In this case, the line of contact is, in effect, the probable line of deployment.

b. Under conditions of reduced visibility, the effective use of a reserve as a maneuver element is usually impossible because of the difficulties of control and coordination. The company commander normally employs all three rifle platoons in the assault. A reserve is usually withheld only when the company zone of action is extremely narrow or when there is a dangerously exposed flank or rear. If a reserve is held out to provide flank or rear security, the

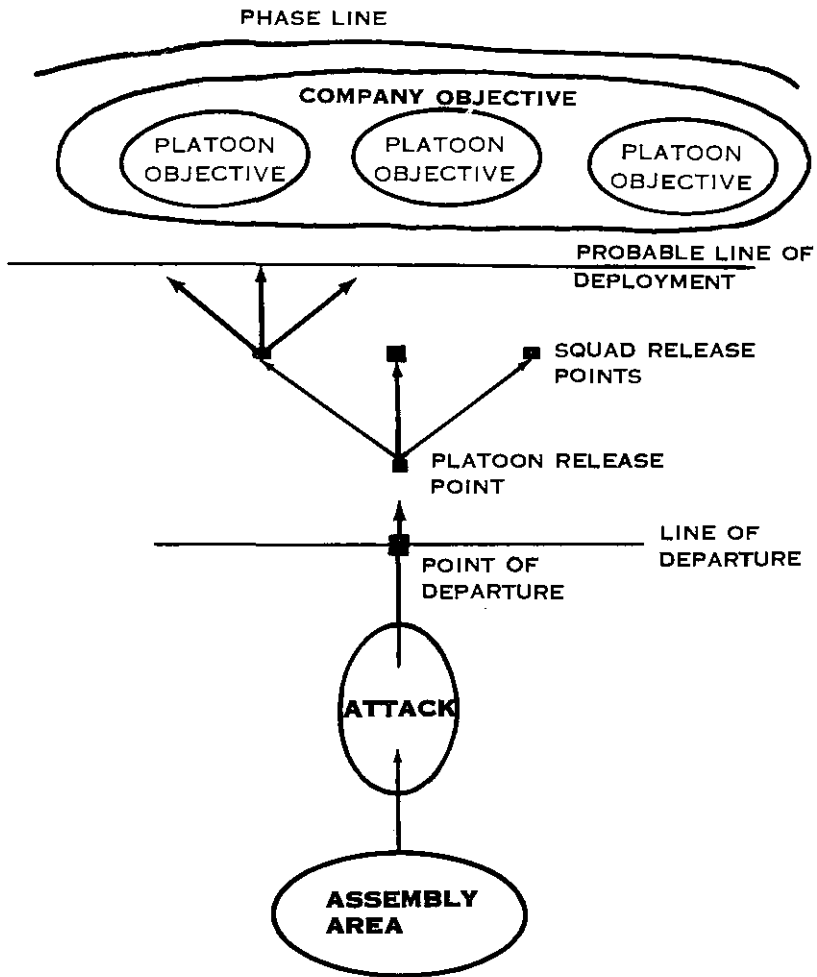

Figure 15. Night attack: Company column of platoon columns (schematic).

company commander may direct it to follow the attack echelon closely, or he may leave it on the LD and have it brought forward by guides or on signal.

95. Security

a. Security patrols are normally sent out before the attack to secure the PLD. One security patrol of four to six men is generally sent from each platoon. The company commander orients patrol leaders on the route forward to the platoon release point, on respective platoon portions of the PLD, and such other information as they need to know in order to accomplish their mission. Platoon leaders tell their patrol leaders the route from the platoon release point to the squad release points and the location of the

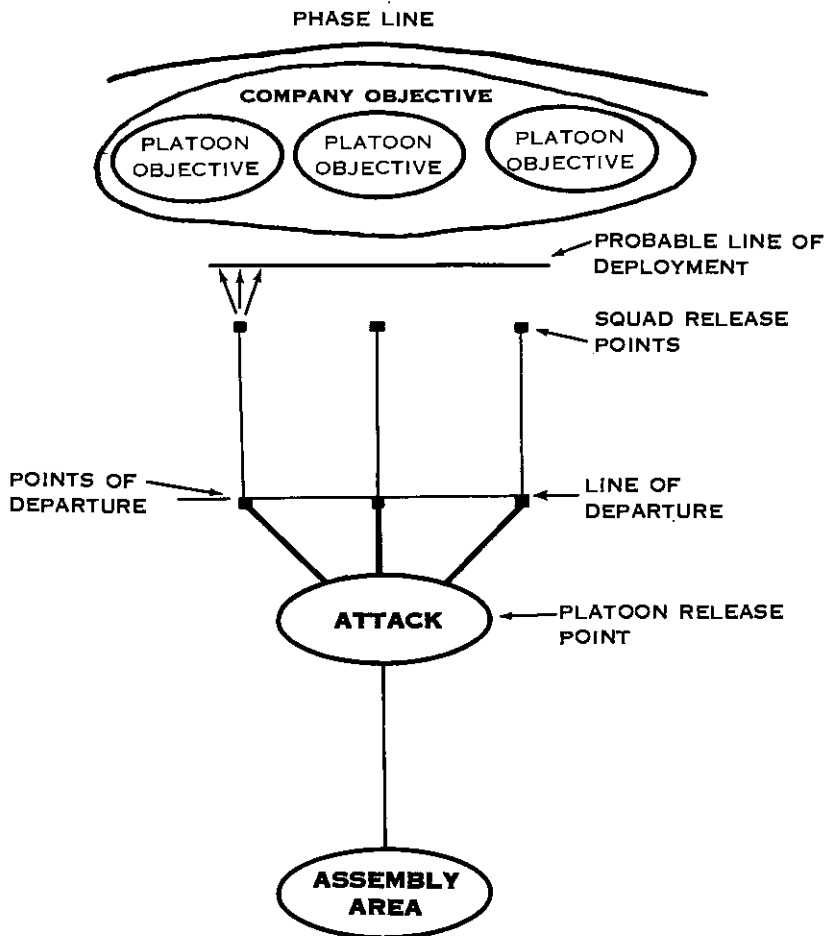

Figure 16. Night attack: Company line of platoon columns (schematic).

squad release points. The company commander designates one of the patrol leaders to coordinate the effort of all patrols. He also designates a time of departure, a time of return (normally shortly before the time of attack), and a place where returning patrol members must report. Normally one or two members of each patrol return, leaving the remainder as security on or near the PLD. Returning patrol members furnish information of the enemy and terrain. After reporting to the company commander, the returning patrol members rejoin their respective platoons to assist the platoon leaders in guiding their platoons forward.

b. Enemy outposts on or near the PLD are kept under surveillance and then eliminated just prior to the arrival of the platoons on the PLD. Enemy encountered from the LD to the PLD are eliminated or bypassed as silently as possible.

c. In addition to security patrols on the PLD, frontal and flank security is provided during the movement from the line of departure to the PLD. The size of these security elements varies with the amount of detailed information of the enemy, the terrain, and likely enemy counteraction. The distance at which these security elements operate depends primarily on the commander's ability to control them.

96. Use of Artificial Illumination

a. The battalion commander normally determines the degree of illumination to be provided. Even though the attack is to be made by stealth, plans are made for the use of available illumination in case it is needed. Battlefield illumination may be planned and provided on schedule or on call.

b. During an attack by stealth, illumination is not usually employed during the advance to the probable line of deployment. During the assault, direct illumination by searchlights and flares may be used to blind and confuse the enemy. Illumination used to aid in consolidation after seizure of the objective is normally limited to indirect illumination (artificial moonlight). Direct illumination can be used to assist in repelling a counterattack.

c. When illumination is used, the attacker may sacrifice much of the secrecy ordinarily gained at night. However, a skillful use of illumination over a period of time may assist in deceiving the enemy as to the exact location of the real attack. The illumination may be extended for a considerable distance on both flanks, so as not to disclose the exact area of the attack. Illumination may be used during all phases of the attack or during the final assault only. Night attacks with illumination are basically conducted in the same manner as daylight attacks. However, the problem of control and coordination is greater, dispersion is less, and movement is slower. With illumination, the mechanized infantry rifle company (infantry and airborne infantry when APC are attached) may conduct a mounted attack. Although the enemy can detect this type attack, tactical surprise can be achieved since the rapidity of movement of mounted forces is such that the enemy may not have time to react in the use of his reserves.

d. Infrared illumination, in conjunction with appropriate viewing devices, may be used to facilitate movement, control, and firing of weapons.

97. Use of Supporting Fires

a. If the attack is to be made by stealth, some fires may be delivered to maintain the pattern existing prior to the attack. The supporting fires are planned in detail and weapons are positioned

and registered, but they are normally delivered only on call under conditions specified by the battalion commander. Fires are planned on the objective to support the attack if it is prematurely discovered, to protect the flanks, and to isolate the objective during the assault and consolidation.

b. Use of supporting fires in an illuminated attack closely parallels a daylight attack.

98. Use of Organic Weapons and Attachments

a. The 81-mm mortar section is normally employed in general support for ease of control and flexibility. The weapons are positioned and registered as necessary on desired target areas by daylight. If the objective is within effective range, the weapons may be left in initial firing positions to capitalize on the registered data until daylight or until continuation of the attack necessitates displacement.

b. The antitank squads are usually employed in general support also. If secrecy can be maintained, they may be moved to firing positions at dusk prepared to deliver fires on call. If this action is likely to alert the enemy, the squads do not support the attack, but are kept in defilade behind the line of departure ready to move to the objective as soon as it is seized. Since ATGM's cannot operate during periods of reduced visibility, artificial illumination must be made available if the weapon is to be used.

c. The weapons squad of the rifle platoon normally moves in column at the rear of the platoon during movement to the probable line of deployment. Depending on the visibility, it may follow the assaulting squads at a specified distance, support the assault echelon, or protect the flanks and rear. The weapons squad should not be so close to the assaulting squads that it becomes involved in close combat; yet, it must be immediately available to support the consolidation.

d. In an attack by stealth, tanks normally stay back of the line of departure ready to move to the objective as soon as it is seized. They may be moved into firing positions and laid on targets at dusk, if such action will not alert the enemy. When tanks are attached to the company and visibility permits, they may be used as a maneuver element similar to a daylight attack. Illumination can be furnished by tank mounted searchlights found in the company. (See FM 17-1.)

e. Portable or mechanized flamethrowers may be provided to the company. They are generally further assigned to rifle platoons and are fired only after the assault has been launched. At night, flame weapons have a psychological as well as destructive effect on the enemy. When stealth is mandatory, only portable flamethrowers can be used initially.

99. Plan for Reorganization and Consolidation

This plan is generally the same as for a daylight attack. The phase line prescribed by the battalion commander restricts the area in which elements of the company can be positioned. Because of reduced visibility, areas where platoons will consolidate should be delineated by easily recognizable terrain features. To facilitate the positioning of supporting weapons and tanks, plans are made for guides to meet these elements at specified points to lead them to their position areas. Special measures may be required to permit rapid resupply of ammunition, evacuation of casualties, and other actions during the reorganization.

100. Conduct of the Attack

a. Guides are used and routes are marked as necessary to aid the movement to the attack position or line of departure. The company occupies the attack position for the minimum time needed for final coordination and last minute instructions. Patrol members rejoin their respective platoons after reporting to the company commander.

b. The company commander normally leads the company to the platoon release point. Usually, other leaders also march at the heads of their units to facilitate control. Frontal and flank security is maintained during movement to the probable line of deployment. Once the company crosses the line of departure, movement is continuous, and the rate of advance is slow enough to permit silent movement. Enemy encountered from the line of departure to the probable line of deployment are eliminated or bypassed as silently as possible.

c. When attacking without supporting fires, the company commander calls for those fires at any time during the movement forward when it becomes evident that the attack has been discovered. In this case, the company deploys at once from the column formation, continues rapidly to the PLD, and deploys on line; fires are shifted, and the company launches the assault as in a daylight attack. If the company is reasonably close to the probable line of deployment when the attack is discovered, it should deploy rapidly, and launch the assault without hesitation. Illumination may be requested to assist in control and as a countermeasure to blind the enemy.

d. If flares are fired during the movement forward to the probable line of deployment, all individuals quickly assume the prone position until the flares burn out. The time for firing friendly flares must be coordinated to insure that the company is not exposed prematurely.

e. The patrols securing the PLD should eliminate enemy listening posts in this area as silently as possible just before the company arrives. As the squads approach, they deploy on line. Members of the security patrols assist in positioning squads on the PLD and then rejoin their own squads.

f. Normally, platoon leaders report to the company commander when their platoons are in position and ready to continue the movement forward. The company commander directs the movement to continue according to orders from the battalion commander. He may do this by ordering the base platoon to move out, or by any other means consistent with security. The company continues the advance by moving forward *silently* in line without firing.

g. When the attack is discovered during this movement, the assault is begun. The authority to begin the assault is normally delegated down to and including platoon leaders. Under some circumstances it may be delegated to rifle squad leaders. Scattered fire by small elements of the enemy must not be misconstrued as loss of surprise and should not be the signal to start the assault.

h. The importance of developing a great volume of fire during the assault cannot be overemphasized; it is at this time that fire superiority must be established. The assault is conducted aggressively; individuals are encouraged to shout and create as much noise as possible. Riflemen fire from the underarm position, and automatic riflemen fire from the hip position. Tracers may be used to increase the accuracy of fire and to demoralize the enemy. The company commander may at this time call for supporting fires to isolate the objective and for direct illumination. The assault should be carried to the military crest on the far side of the objective.

i. Once the objective has been seized, platoons move to their designated areas and consolidate. Squad and platoon leaders establish their flanks on previously indicated terrain features and gain contact with adjacent units. Local security is established, alert for a possible counterattack. Ammunition is redistributed, supplies are brought forward, key members of the company who have become casualties are replaced, the company command post is displaced, casualties are evacuated, and status reports are made to the next higher headquarters. The company commander checks his supporting fires to determine if they cover the approaches most dangerous to the company. Organic and attached weapons may be displaced forward and guided into position. An organized mopup of the enemy in an overrun area is normally conducted after daylight. However, this does not prevent taking action against enemy individuals or groups that interfere with the reorganization and consolidation.

j. If the attack is to be continued beyond the initial objective, it is usually done at daylight as discussed in paragraph 69.

Section IX. RIVER CROSSINGS

101. General

a. The purpose of a river crossing operation is to move an attacking force rapidly across a river obstacle so that it may continue its attack to seize an assigned objective(s). This operation differs from other ground attacks generally as follows:

- (1) More specialized equipment and personnel are required.
- (2) Limited areas suitable for crossing often tend to canalize the attack.
- (3) Control of units is difficult because of the obstacle itself, restrictions imposed by space, and the employment of units of several arms and services.
- (4) Tactical courses of action are limited, since deployment and firepower are restricted while the troops are astride the river.
- (5) Once forces are committed to action, it is hard to deviate from the initial plan.

b. There are two general types of river crossings: hasty and deliberate.

- (1) A crossing is termed *hasty* when it is conducted as a continuation of the attack, with minimum loss of momentum, by the same forces which advance to the river line. It is made with the crossing means that are at hand or readily available. A hasty crossing may be feasible when enemy defenses on the far bank are weak or when bridges or fords are captured before the enemy has a chance to destroy them. This type of crossing is characterized by speed, surprise, and minimum concentration of personnel and equipment. See paragraph 103.
- (2) A *deliberate* crossing is characterized by some delay, more detailed preparation and planning, and the employment of extensive and specialized crossing means. It may be conducted as a resumption of the offense or as a result of an unsuccessful hasty crossing; or when a hasty crossing is not desirable because of the difficulty of the obstacle or the strength of enemy defenses.

c. For other discussion of river crossing operations, see FM 31-60 and FM 7-20. For a discussion of the use of helicopters in river crossings, see chapter 6 and FM 7-20.

102. Concept

a. Higher headquarters provides detailed information of the river and its defenses to the attacking troops before they arrive at the river line. When existing crossing means can be seized before the enemy can destroy them, they are used for a hasty crossing. When a hasty crossing cannot be effected, the attacker eliminates enemy forces on the near side of the river and prepares for a deliberate crossing. Normally, the near bank is secured by troops other than those assigned to make the assault crossing.

b. In any river crossing the effectiveness of the river as an obstacle is reduced through surprise and deception and by the speed of the attack and buildup of forces on the far side. Every effort is made to maintain secrecy and to deny the enemy information, such as the time of crossing and location of crossing sites. Deceptive measures, such as feints and demonstrations, are prescribed and coordinated by higher headquarters. Plans may call for the extensive use of smoke.

c. A river crossing is normally made on a wide front to facilitate dispersion, rapid crossing, and deception. The size of the initial wave is limited solely by the available crossing means and sites.

d. When possible, assault units cross in helicopters and/or APC and, normally, seize relatively deep objectives. The mechanized units link-up rapidly with the airmobile forces. When helicopters and/or APC are not available, or their use is not feasible the assault units must cross in boats. In this case, they have limited mobility after crossing, and are normally assigned initial objectives closer to the river. An assault company generally crosses in two waves, whether in boats or APC.

e. The attacker must rapidly seize objectives on the far bank and eliminate enemy resistance so that rafts, bridges, and other crossing means may be constructed for the rapid buildup of forces on the far side. When the assault crossing is made by boat, the assault units usually clear the far bank of effective enemy resistance. When the attacking units cross in APC or helicopters to seize relatively deep objectives, this task is more frequently assigned to reserves.

f. Since the enemy will attempt to destroy the attacker while he is astride the river, the first waves to reach the far bank attack aggressively to keep the enemy off balance while the following forces are crossing.

103. River Crossing Using Armored Personnel Carriers

a. *General.* Since APC are amphibious, a mechanized rifle company (and other types of rifle companies when APC are attached) can make either a hasty or deliberate crossing at sites where there

are no bridges or fords. Separate platoons may make a hasty crossing as they arrive at the river when speed is essential to capitalize on a discovered enemy weakness. Tanks, antitank squads, and other fire support elements that cannot cross immediately, support the rifle platoons from positions on the near bank.

b. Planning and Preparation.

- (1) Before making a deliberate crossing, the company commander and as many as possible of his subordinate leaders (including vehicle commanders) reconnoiter the ground to select routes forward and suitable sites for the APC to enter and leave the water, to determine conditions of the river and its banks; and to locate underwater obstacles. The company commander designates a portion of the near bank for each platoon. Based on his estimate of downstream drift, he may also designate a general area on the far bank where each platoon will land. Platoon leaders select specific sites where each of their vehicles will enter the water and, if possible, where each will land on the far bank.
- (2) The company commander may select intermediate platoon objectives for control when it appears that the attacking platoons will have to halt briefly while the weapons platoon crosses. Any delay of the attack echelon should be kept to a minimum because of the desirability of seizing the assigned objective quickly.
- (3) If there are enough crossing sites, an entire mechanized rifle company may cross in the first wave. If crossing sites are limited, the company may cross in two or more waves. When this situation occurs, the company commander insures that the most essential elements of his company are placed in the first wave.
- (4) The antitank squads may support the first wave by fire from positions on the near side of the river. In this case, plans are made to cross these squads in the second wave and as soon as possible after the far bank has been seized so they can provide antitank protection for the attack echelon. The weapons may be crossed in the first wave to provide immediate protection on the far bank.
- (5) The 81-mm mortar section will support the first wave by fire from positions on the near side of the river. Plans are made to cross the section in the second wave so it can provide close and continuous fire support during movement toward the assigned objective.
- (6) In addition to the usual preparations for an attack, the APC and their loads are checked to insure that they can

safely enter the water. For a discussion of these checks and of loading, see appendix V.

- (7) For additional discussion of attack planning, see paragraphs 52 through 61.

c. *Conduct of the Attack.*

- (1) Movement forward from the assembly area is continuous and rapid. Multiple routes are used as necessary. An attack position is seldom used. Upon approaching the river each platoon deploys as the terrain permits with the leading APC downstream from the others in the platoon. This formation reduces the chances of collision in the water. The APC .50 caliber machineguns are fired as necessary. As they near the landing sites, individual APC may be required to maneuver slightly to land at a suitable spot. (See app. V.)
- (2) After negotiating the far bank, the APC continue their movement toward the objective. When an APC cannot climb the far bank at its assigned site, it backs into the water and lands at another site. Every effort is made to avoid congesting the crossing area. When a sizeable number of the APC are unable to climb the bank, the platoon leader(s) concerned normally orders the men to dismount through the top hatches and continue the attack on foot. The APC rejoin their platoon(s) as soon as possible.
- (3) The company commander normally controls the initial crossing from a vantage point on the near bank. If it is heavily opposed, he may order the reserve to cross at a lightly defended site. He tries to maneuver the reserve to strike the enemy in the flank or rear.
- (4) Upon the successful crossing of the first wave, the company commander orders his remaining elements to cross according to the demands of the situation. They may cross in one or more succeeding waves. The interval between waves is based on such factors as enemy resistance, congestion of the crossing area and far bank, fire support requirements, and the need for speed. The company commander normally crosses in his APC immediately after the first wave has successfully crossed.
- (5) Certain wheeled vehicles and personnel of company headquarters do not participate in the assault crossing. They are usually controlled by the executive officer. They cross as directed by battalion when means become available.
- (6) The attack on the far bank is conducted as described in

section IV. Enemy elements may be bypassed if they do not threaten the accomplishment of the company's mission.

104. Planning a Crossing Using Boats

a. General. An assault company that crosses by boat usually has the initial mission of seizing terrain from which it can prevent the enemy from placing effective direct small arms fire on the crossing site. Boat crossings may be made by day, but normally it is preferable to make them at night or under other conditions of reduced visibility. The time of attack, which is specified by higher headquarters, may be planned so that the boats and attacking troops move to the river during darkness and the first wave crosses and lands on the far bank at or shortly before dawn. The near edge of the river is normally designated as the LD.

b. Reconnaissance. The company commander and as many subordinate leaders as possible (to include boat team leaders) reconnoiter the ground as the situation and available time permit. They make every effort to insure that their reconnaissance activities do not compromise the secrecy of the operation. Items of particular concern during the reconnaissance are routes forward, the attack position, boat positions and launching sites, condition of the banks and the river, and plans of the engineer unit. An engineer officer usually assists the company commander during this period, making recommendations and providing technical assistance. The company commander selects a portion of the near bank where each platoon will begin its crossing, and he may designate general landing areas on the far bank. The platoon leaders select the specific launching site for each of their boats and, if possible, landing sites on the far bank.

c. Attack Position. The battalion commander normally selects the company attack position. It is generally the location where infantry troops and the boats with engineer crews are brought together. The company commander assigns portions of the attack position to each of his subordinate elements so that the company is dispersed to the maximum extent possible, consistent with the accomplishment of the mission.

d. Boat Positions. The company commander and supporting engineer commander decide where to place the boats in preparation for the crossing. Normally, they will be placed in the attack position, close enough to the river to permit easy carry by the platoons. If the attack position is more than 300 meters from the river, boat positions closer to the river will be selected, if possible. Boats for each platoon are placed directly back of their launching sites.

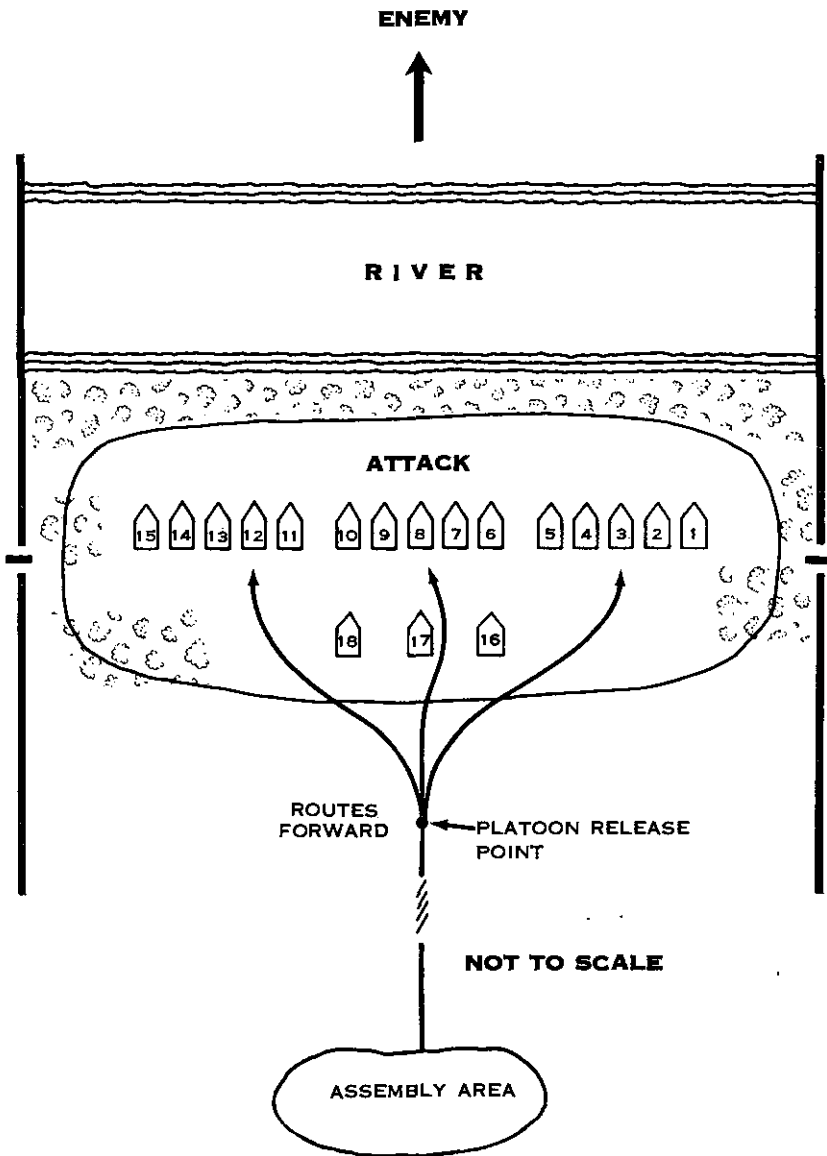
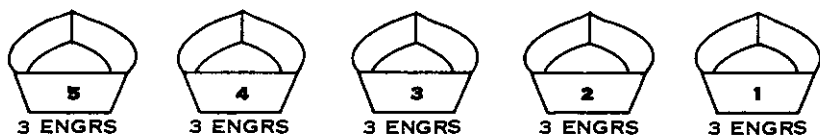

Figure 17. Organization of boats for assault crossing (schematic).

e. Objectives. The initial objective assigned the company is normally relatively close to the river. Intermediate platoon objectives are usually unnecessary.

f. Formation. The company usually crosses with three platoons in the first wave and assaults in this formation. Normally, no reserve is retained because it cannot move to a critical area in time to influence the action early in the operation. After the initial

FIRST WAVE



WPNS SQD LDR	1	SQD LDR	1	PLAT SGT	1	PLAT LDR	1	RIFLE SQD	
FIRE TEAM	5	FIRE TEAM	5	SQD LDR	1	FO PARTY (81)	2		
MG TEAM	2	RKT LAUNCHER	5	FIRE TEAM	4	FIRE TEAM	4		
AMMO BEARER	1	TEAM	2	MG TEAM	2	RAD TEL OPR	1		
				AMMO BEARER	1	RKT LAUNCHER	1		
						TEAM	2		

Figure 18. A type assault boat loading plan for a rifle platoon.

objective has been seized, the company commander designates a reserve and selects a formation for continuing the attack.

g. Assignment of Crossing Means. The attacking company normally has 18 assault boats which permit it to cross without shuttling. In a typical crossing, the first wave consists of the rifle platoons, and the second consists of the company command group and the 81-mm mortar section. The normal organization is 15 boats in the first wave (allowing 5 boats per platoon) and

SECOND WAVE



COMPANY CMDR	1	WPNS PLAT LDR	1	XO	1
FIRST SERGEANT	1	RADIO TEL OPR	1	COMM CHIEF	1
RADIO TEL OPR	1	MORTAR SQD	5	WIREMAN	1
MORTAR SQD	5	FD COMPUTER	1	RADIO TEL OPR	1
MORTAR SEC LDR	1	WIREMAN	1	ARMORER	1
AIDMAN	1	ARTY FO PARTY	2	MORTAR SQD	5
				FD COMPUTER	1

Figure 19. Type loading plan for the second wave.

3 boats in the second (fig. 17). The current assault boat can carry 15 men, 3 of whom are engineers who operate the boat. The number of men must be reduced when heavy ammunition and equipment are added to a boatload. In organizing rifle platoons into boat teams, every effort is made to maintain tactical unity of the squads. The two machineguns should not be placed in the same boat, and key platoon personnel should not cross in the same boat. For type assault boat loading plans, see figures 18 and 19.

h. Weapons Platoon. The 81-mm mortar section normally crosses in the second wave and supports the attack from positions on the far side of the river. It may support the first wave crossing from the near bank when other available fire support is inadequate. The antitank section usually supports the crossing from positions on the near side of the river and crosses as soon as means become available. If helicopters are available, the antitank sections may be lifted across the river early in the operation.

i. Engineer Support. Effective coordination with supporting engineers is essential at all times during the operation. In addition to placing the boats in position, furnishing boat crews, and providing technical assistance, the engineers furnish guides to assist the boat teams in reaching the boats. Generally, a minimum of one guide is required for each platoon. An engineer crew of three men normally operates each assault boat, with two in the bow and one in the stern. The sternman steers and has technical command of the boat. The infantry boat team leader has tactical command of the boat and tells the sternman where to land. The engineer crew assists the boat team in embarking, paddling, and debarking. After the boat team debarks, the engineer crew returns the boat to the near bank.

j. Communications. During the early stages of a river crossing, radio is the principal means of communication. It is supplemented by visual signals and messengers. Two boats in the second wave normally lay wire lines across the river to provide wire communication with battalion.

k. Resupply. After crossing, the only supplies immediately available to the attacking elements are those carried by the men. In addition to the ammunition carried by individuals, each boat normally carries a small amount of extra ammunition and other critical items. It is dropped on the far bank where elements of the second wave collect and sort it and establish a company distributing point. Individuals carry rations as required. Normal resupply is reestablished when means become available to cross preloaded vehicles. Helicopters may also be used for resupply.

l. Rehearsal. Whenever time, terrain, and equipment permit, full-scale rehearsals are conducted to closely simulate the crossing.

If conditions do not permit a full-scale rehearsal, the company commander should request assault boats for dryland training. The training should include designating paddlers and nonpaddlers, carrying the boats, and simulating launching, loading, paddling, and debarking.

m. Reference. For additional discussion of attack planning, see paragraphs 52 through 61.

105. Conduct of the Crossing Using Boats

a. Boat teams are organized and all plans and orders for the crossing are completed in the assembly area. The movement from the assembly area to the attack position may be made on foot or by vehicle. It is made as rapidly and with as much secrecy as possible. The order of march is designed to permit continuous movement into and out of the attack position. Engineer guides meet the platoons in the vicinity of the attack position and guide them directly to their boats. If the timing of the movement has been correct, the boat teams halt no more than momentarily before they pick up their boats and move to the water. They launch and load their boats, then paddle across the river without a halt and with all the speed they can muster. They do not fire their weapons while crossing since riflemen either paddle or hold weapons for those who do paddle. When they reach the far bank, they debark and move forward rapidly toward their initial objective.

b. The company commander remains on the near bank where he can best observe the action as the first wave crosses. As soon as the first wave has crossed, debarked, and cleared the far bank, he orders the second wave to cross. He crosses with the second wave. The second wave should land by the time the first wave has advanced far enough to give the 81-mm mortars room to go into position to support the attack.

c. The attacking platoons fight initially as boat teams. Squad and platoon leaders regroup their units while on the move and complete their reorganization after the first objective has been seized. The far bank is mopped up concurrently with the advance. Failure to do so can endanger the crossing of subsequent waves and the operation of engineers at raft and bridge sites.

d. For additional discussion of the conduct of the attack on the far side of the river, see paragraphs 62 through 69.

Section X. RAIDS

106. General

a. A raid is a surprise attack on an enemy force or installation, with the raiding force withdrawing after accomplishing its mis-

sion. A raid is usually ordered by the battalion commander and may be conducted by all or part of the company.

b. A raiding force may be assigned such missions as destroying key installations, command posts, supply dumps, and nuclear delivery means; capturing prisoners or materiel; or harassing the enemy to disrupt his operations.

c. The success of a raid depends largely on the element of surprise. For this reason, raids are frequently conducted at night or during adverse weather, or on difficult terrain which the enemy may consider impassable.

d. The size of the raiding force is the smallest that can reasonably be expected to accomplish the mission. The difficulty of achieving surprise and maintaining control increases in proportion to the size of the raiding force.

e. The use of air transport permits a raiding force to bypass enemy positions, terrain, and distance barriers. In an airborne raid (parachute delivered or airdropped), the force is more apt to operate beyond supporting distance of its parent unit than in other types of raids.

f. For a discussion of raid patrols, see FM 21-75; airborne raids, see FM 57-10 (when published), FM 7-20, and FM 61-100.

107. Planning

a. *General.* Thorough planning is essential to the successful execution of a raid. Detailed advance information of the enemy, to include night dispositions, is obtained. Prior to the conduct of a raid, information of the enemy's dispositions are generally obtained by patrolling, debriefing of line crossers, and information obtained by higher echelons. All activities in preparation for the raid are conducted in secrecy.

b. *Organization.* The commander of the raiding force organizes his unit into an assault element and a security element. Each element is organized and equipped to accomplish a specific part of the overall mission. The size and composition of the elements depend on the tasks to be accomplished and the expected resistance at the objective. The assault element may use special equipment such as demolitions and flamethrowers, and it may include special teams such as engineers (FM 7-15). The assault element eliminates hostile resistance at the objective and performs specific combat tasks as required. If airdropped, it may be supported by the suppressive fires of the transporting helicopters. The security element provides security and isolates the objective while the assault element attacks.

c. *Route of Advance and Withdrawal.* Routes are selected to avoid known or suspected enemy positions. The route of advance

should be concealed and covered. The raid is launched from the last concealed position. Advance and flank security detachments may precede the raiding force and silently dispose of enemy security elements along the selected route to prevent premature discovery. Although the withdrawal may be conducted over the same route used for advance, alternate routes of withdrawal are selected and plans are made for their use. Provisions are made to keep withdrawal routes open by use of security elements and/or prearranged fires.

d. Rallying Points. Rallying points are designated along the route to and from the objective. They should provide concealment and cover, be defensible for a short period of time, and be easily recognized and known by all members of the unit.

e. Fire Support Plan. A complete and detailed fire support plan is prepared even though the fires may not be used. Supporting fires are planned to isolate the objective, to prevent or limit hostile counterattacks, and to aid in keeping open the route of withdrawal. Their use at the outset decreases the element of surprise, but this must be accepted in the face of a strong enemy position.

f. Security. Security is maintained while planning and conducting a raid to deny the enemy knowledge of its exact location, direction, and objective. Higher headquarters may plan and conduct feints to increase the chances of gaining surprise. During the raid, the raiding force commander protects his flanks with flank security detachments and by using prearranged fires on probable avenues of enemy approach. He gives the security elements definite instructions regarding their dispositions and the time or signal for withdrawal.

g. Rehearsals. When possible, the raiding force rehearses on terrain and under light conditions similar to those that will be met on the raid. The rehearsal is repeated as necessary to insure that all members can perform their task well.

h. Airborne Raids. In addition to the considerations listed in *a* through *g* above, the following aspects should be considered in planning an airborne raid (either parachute delivered or airlanded):

- (1) Plans for the movement are designed to deliver the raiding force to the objective area intact with a minimum risk of detection. Routes are carefully selected to avoid enemy positions and to take advantage of defilade. Deceptive measures may be used.
- (2) Withdrawal by air is usually difficult and requires detailed primary and alternate planning. If an airlanded raiding force can complete its mission in a relatively short time, the delivery aircraft may be able to remain

at the landing area, covered by a security force, until the force is ready to withdraw. If waiting is likely to expose the aircraft unduly, they may leave and rendezvous with the raiding force at a predesignated place and time. (See also pars. 220-225.)

- (3) An airborne raiding force can strike deep in enemy territory, but may need support from other services which must be thoroughly coordinated. Such a force may also be able to work in conjunction with partisan or guerrilla forces.
- (4) Planning and preparations for an airborne raid closely parallel those for an airmobile assault (pars. 210-214). The plan of attack described for the airborne assault is modified to incorporate considerations appropriate to ground raids.

108. Conduct

a. During a ground movement to the objective area, every effort is made to bypass enemy elements and escape detection. Security elements normally operate to the front and on the flanks of the main force. If a security detachment becomes engaged, the main force attempts to avoid the action.

b. In the case of an airborne raid, elements of the raiding force normally assemble independently immediately upon landing, then start on their assigned tasks without waiting for further assembly.

c. As soon as an airborne or ground raiding force arrives, its security elements take positions where they can block approaches and prevent enemy reinforcements from moving into the objective area. They also prevent enemy within the objective area from escaping. When the security elements are in position, the assault element attacks or performs whatever task the mission calls for. It tries to accomplish its mission in a minimum amount of time. If the mission calls for an attack, it must be quick and violent so as to capitalize on the enemy's surprise.

d. When the force completes its mission, it reassembles at the rallying point and withdraws. Supporting fires are delivered as necessary to assist in breaking contact. Security elements operate to the flanks and rear of the force to cover its withdrawal. Fast movement is essential. Security elements operating ahead of the main body increase the chances of bypassing enemy positions.

e. Casualties are assembled at specified points for evacuation. The commander does not divert any of his combat strength to evacuate casualties until the mission has been accomplished and the force is ready to withdraw.

f. A portion of the raiding force may be assigned to act as a stay-behind force. For more discussion of the actions of stay-behind forces, see paragraph 167.

Section XI. ANTIGUERRILLA OPERATIONS

109. General

a. The rifle company may expect to participate in antiguerrilla operations, either as a rear area security unit or in situations where such operations are the primary mission of all forces involved.

b. Guerrilla forces characteristically employ tactics designed to offset the superior combat power of conventional military organizations. Using these tactics, relatively small numbers of guerrillas can tie down and inflict extensive damage on much larger and more highly organized forces.

c. The guerrilla element is usually found in areas where the terrain minimizes the mobility, surveillance, and firepower advantage of the antiguerrilla force. Guerrillas are more familiar with the terrain in the area of operations than the antiguerrilla force.

d. Guerrilla activities are characterized by small group actions which capitalize on stealth, surprise, unorthodox tactics, and rapid withdrawal or dispersal when effective opposition is encountered.

e. Effective intelligence and counterintelligence measures are essential to success. Indigenous sources are utilized to the maximum extent. Whenever possible, allied troops native to the area should be employed against hostile resistance elements. Their familiarity with the country, people, language, and customs make them invaluable.

110. Employment of Forces

a. Conventional units are organized for combat into a number of small, variable size task forces capable of semi-independent action without the tactical support normally provided.

b. A mobility differential over the guerrilla force must be attained. Dependent upon the area of operations, this will require a high degree of training in foot movement, extensive use of aircraft, particularly helicopters, and suitable ground and water transportation.

c. Small special units may be organized, equipped, and trained to combat guerrillas by using their own tactics and techniques. Such special units might consist of selected United States and allied military and police units augmented by trackers and guides familiar with the terrain. The unit is designed to hunt down and

destroy small guerrilla bands and to establish and maintain contact with large guerrilla formations until arrival of friendly reinforcements.

111. Training of Antiguerilla Forces

Individuals and small unit training should emphasize—

a. Tactics and techniques, to include use of supporting weapons, used by small units in expected operational environments, i.e., built-up areas, mountains, deserts, and swamps.

b. Long range combat patrol operations under primitive conditions and utilizing only such supplies as can be transported with the patrol.

c. Immediate reaction to unexpected combat situations.

d. Techniques of raids, ambushes, and defensive and security measures against these types of operations.

e. Employment of Army aviation, to include tactics and techniques of airmobile operations.

f. Aerial supply by Army and Air Force aircraft to include terminal guidance, drop zone marking, and materiel recovery techniques.

g. Helicopter loading and unloading to include external and internal loads.

h. Cross-country movement at night and under adverse weather conditions to include tracking and land navigation.

i. Police type search and seizure techniques, counterintelligence and interrogation measures.

j. Guard duty, police type patrolling and control of civilians, to include the operation of road blocks and checkpoints.

k. Convoy escort and security to include the use of armed helicopters.

l. Advanced first aid.

m. Cross-training on all communication equipment available within the type unit and all communication techniques.

n. Cross-training in all individual and crew-served weapons available within the type unit.

o. Indoctrination in the ideological and political theories of the resistance movement, with emphasis on the fallacies and weaknesses.

p. Civil affairs training.

q. The construction and use of obstacles.

r. Psychological preparation of the individual soldier intended to develop patience and perseverance when on prolonged "isolated type" missions.

112. Antiguerrilla Tactics

a. The most effective means of destroying the hostile guerrilla force is to conduct a continuous aggressive offense. Continuous pressure is maintained by vigorous combat patrolling. This keeps the guerrillas on the move, disrupts their security and organization, separates them from their base of supply, weakens them physically, destroys their morale, and denies them the opportunity to conduct effective operations. For a consideration of appropriate patrolling techniques, see FM 21-75.

b. Once located, the guerrilla force can be most effectively eliminated by encircling it. If the force is small and located in a relatively confined area, the rifle company or its elements may be able to eliminate the resistance independently. If on the other hand, the force is large and/or occupies a large area, a force greater than a rifle company may be necessary to insure successful elimination of the guerrilla element.

c. Tactical considerations used when closing with the enemy are the same as described in paragraphs 47 through 69. (See also FM 7-20.)

113. References

The following references pertinent to operations against irregular forces are available:

- a.* FM 31-15, Operations Against Irregular Forces.
- b.* FM 21-50, Ranger Training.
- c.* FM 7-15, Infantry, Airborne Infantry, and Mechanized Infantry, Rifle Platoon and Squads.
- d.* FM 21-75, Combat Training of the Individual Soldier.
- e.* FM 21-77, Evasion and Escape.

Section XII. INFILTRATION

114. General

a. The company participates in an infiltration operation as a part of a larger force. Infiltration techniques are used in offensive operations and may be used as a means of obtaining intelligence and harassing the enemy.

b. Because of the dispersion that can be expected on the nuclear battlefield, infiltration as a technique will be emphasized. A further consideration is that the vulnerability of the attacking unit is reduced by the enemy's inability to employ large nuclear weapons against such attacks where both friendly and enemy units will be interspersed in their deployment.

115. Basic Considerations

a. An infiltration is a relatively long operation with detailed planning and thorough briefings of personnel. Since movement will be by stealth, the movement of forces will be slow. Infantry units are most suited for this task. The use of airborne forces will increase the rate of movement.

b. The terrain used should limit the enemy's observation and use of surveillance devices. Woods, swamps, and broken ground are best suited for infiltration. Within the area, suitable routes for movement should be available. Avenues of approach, in the accepted sense, are not used since it can be expected that the enemy will have these under observation and planned fires. Conditions of reduced visibility increase the chances of success.

c. It will be normal to adopt infiltration techniques when the enemy presents a dispersed force with gaps existing between units. If the enemy is alert and equipped with detection devices, deception and diversionary measures must be used.

d. Objectives for infiltration are key terrain features such as crossroads, defiles, and others which restrict the movement of the enemy's reserves or isolate his defensive positions.

e. Infiltration is difficult to control and coordinate. Deviations from plans are difficult to coordinate during the operation. Close coordination must be made with supporting fires and units that will link-up with the infiltrating force. (For a discussion of link-up operations, see ch. 6.)

f. Within the area, infiltration lanes are established as control measures along with phase lines, checkpoints, attack positions, objectives, and rallying points or areas. When infiltration lanes are drawn on an overlay, their width will be specified to facilitate control of friendly fires adjacent to the lane. (See also FM 7-20.)

g. Communication must be established within the infiltrating unit and with the controlling headquarters.

h. Infiltrating units generally move by foot and are limited to hand carried weapons.

i. Because of the nature of the operation maximum dissemination of information must be accomplished.

j. Figure 20 depicts the company attacking by infiltration.

116. Conduct of the Infiltration

a. Depending on the terrain and enemy situation the company may move as a unit or be broken down into platoons, squads, or detachments. Elements move through the enemy's defensive position avoiding detection, and decisive engagement if detected. The company will use one or more infiltrating lanes, depending on the

formation adopted and the size of the unit conducting the infiltration, to move to attack positions.

b. Upon arrival in the attack position the company conducts operations as described in paragraphs 62 through 69.

c. Groups which lose their direction or are unable to reach the attack position proceed to rallying points or areas.

d. When helicopters are used to move forces in the infiltration, the aircraft fly individually or in small formations. During and after movement to the attack position, aircraft simulate landing at other points as a deception measure. (For more discussion on use of aircraft, see ch. 6.)

e. For more information on infiltration, see FM 7-20.

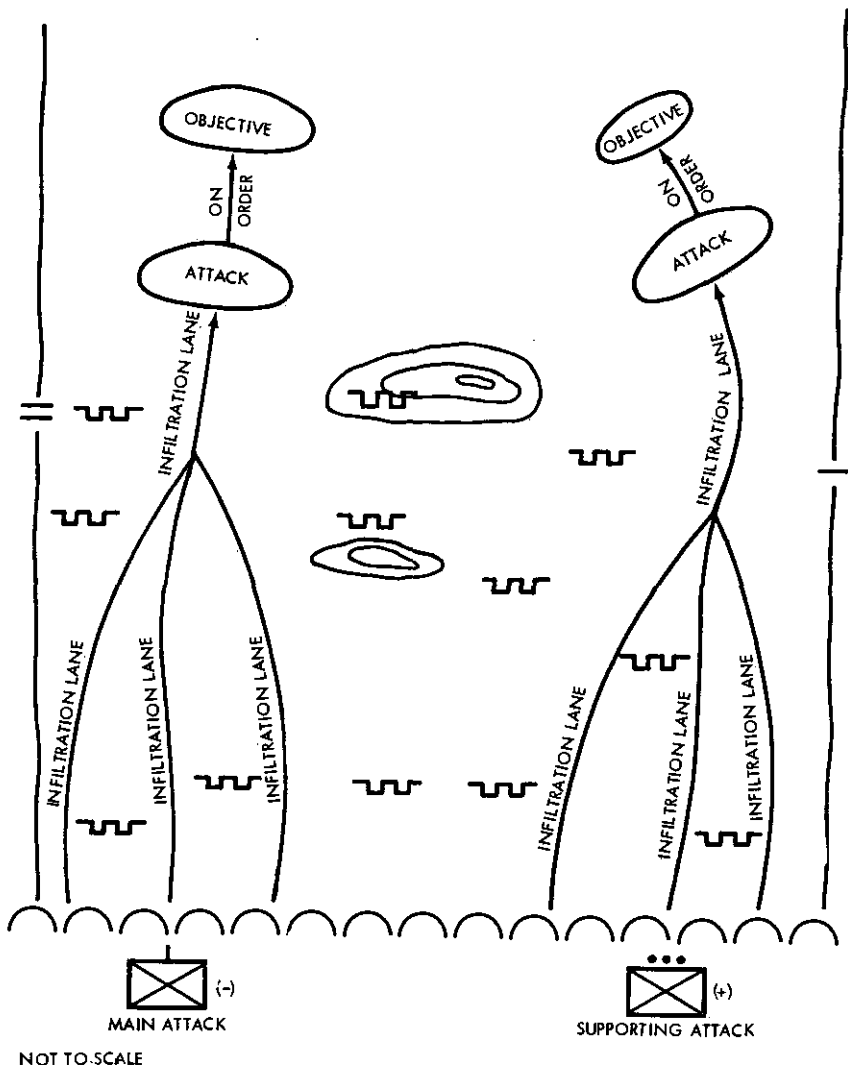

Figure 20. Rifle company conducting infiltration (schematic).

CHAPTER 4

DEFENSE

Section I. GENERAL

117. Mission and Employment of the Company

The mission of the rifle company in defensive operations is to repel the enemy assault by fire, close combat, and counterattack. The rifle company defends as part of a larger force to deny a vital area to the enemy, to protect a flank, to gain time, to economize forces, or to disorganize and destroy the enemy. The company accomplishes its mission of defending its assigned area by stopping the enemy by fire in front of the battle area, repelling his assault by close combat if he reaches it and, within its capability, by counterattacking to eject or destroy the enemy if he penetrates the company defense area. In all of the foregoing phases, the destruction of the enemy's forces is paramount.

118. Fundamentals of Defense

The fundamentals used for planning and conducting the defense are discussed below. These considerations do not have equal influence in any given situation nor do any of them apply to the same extent in different situations. The commander decides the degree to which each will affect his planning.

a. *Proper Use of Terrain.* The defender takes maximum advantage of the terrain by placing troops and weapons in positions which offer good observation, fields of fire, concealment and cover, and which block enemy avenues of approach to key terrain.

b. *Security.* The commander adopts security measures to offset the attacker's advantages of initiative and flexibility, by causing him to attack with minimum intelligence. He uses active and passive measures to protect his unit against observation or surprise from any direction.

c. *Mutual Support.* The commander obtains mutual support by positioning units so they can reinforce each other by fire or movement. In situations where gaps exist between units, he emphasizes coordinated surveillance, timely exchange of information, coordinated fires, barriers, and patrolling.

d. *All-Round Defense.* The commander organizes his defensive position so that he can defend from any direction. He does this by preparing and organizing primary and supplementary positions.

e. *Defense in Depth.* The company commander organizes a defense in depth to preserve the integrity of the defense. A shallow defense is vulnerable to a concentrated attack at any one point. Fires are planned throughout the depth of the defensive area.

f. Proper Use of Barriers. Barrier planning includes considerations for the employment of a series of natural and artificial obstacles to restrict, delay, block, or stop the movement of enemy forces. Routes must be available for use by security elements during their withdrawal, by patrols, and by the maneuver element of counterattacking forces. Barriers are particularly important when defending on wide frontages.

g. Coordination of Fire Plans. The fires of infantry weapons, artillery, and naval gunfire, and the use of close air support are carefully planned and expressed in oral orders. These fire plans are closely coordinated with the barrier plan. While a separate written fire support plan is seldom published at company level, the fire support plan provides for—

- (1) Bringing the enemy under fire as soon as he comes within effective range.
- (2) Subjecting him to increasingly heavier fire as he approaches the battle area.
- (3) Breaking up his assault by fires immediately in front of the battle area.
- (4) Destroying him within the company defense area by a combination of fire and maneuver.

h. Flexibility. The company commander achieves flexibility by withholding a reserve to be employed in blocking or counterattacking enemy penetrations, and by centralizing control of his supporting fires. Maintaining an adequate communication system is imperative.

i. Maximum Use of Offensive Action. A spirit of offense must be maintained. Troops must be psychologically conditioned to shift rapidly from the defense to the offense. In many situations there will be opportunities to regain the initiative by offensive action in the conduct of the defense.

j. Dispersion. The company commander must insure that individuals are sufficiently dispersed to avoid excessive casualties from enemy fires. At company level, no attempt is made to disperse as a passive defense measure against nuclear weapons since such dispersion would weaken the company's effectiveness disproportionately to the protection gained. For further information concerning protection against nuclear attack, see FM 21-40 and FM 21-41.

119. Definitions

a. The *area defense* is an operation oriented toward retention of specific terrain. Primary reliance is placed on forces deployed on position, and fires to stop and repulse the attacker. The defending force may not be physically located on key terrain features prior to the enemy attack; however, the commander conducting

the area defense employs sufficient forces in the forward area to create the combat power necessary to dominate the area to be held. The forward areas normally have a higher priority for forces than does the reserve. The reserve is employed to block and destroy the enemy, and within its capability to eliminate penetrations if they occur.

b. The *mobile defense* is a form of defense which may be employed by echelons above battalion. The rifle company does not have the capability of conducting the mobile defense; however, it participates as a part of a battalion in a mobile defense conducted by a larger force. The mobile defense is one in which the minimum combat power of the division is committed in the forward defense area to warn of impending attack, to canalize the enemy into less favorable terrain and otherwise impede, harass, and disorganize him. The bulk of the division's combat power is retained in reserve, positioned for offensive action. The success of the mobile defense depends upon aggressive reconnaissance, the timely receipt of accurate information on enemy strengths, movements, and dispositions, and the ability of all forces to move rapidly. (See FM 7-20.)

c. The *battle area* is the area in which the forward forces and their reserves are located. It is prescribed by coordinating points, boundaries, and sometimes a rear boundary.

d. The *forward edge of the battle area* (FEBA) is the line formed by the forward edge of the forward rifle platoons. It intersects boundaries at coordinating points.

e. The *echelons of defense* are the security area, forward defense area, and reserve area.

f. *Blocking positions* are positions organized to deny the enemy access to a given area or to prevent his further advance in a given direction. They are normally designated in rear of the FEBA.

120. Security Forces

In addition to providing its own local security, the rifle company may—

a. Function as part of the general outpost (GOP) or covering force.

b. Establish and control all or a part of the battalion's portion of the combat outpost (COP).

c. Establish all or a portion of the security for an assembly area of a larger unit.

d. Establish roadblocks and ambushes.

e. Defend rear areas and installations.

f. Participate in operations against airborne attacks, guerrillas, and infiltrators.

g. Patrol unoccupied portions of the FEBA.

121. General Outpost (GOP) or Covering Force

a. The general outpost is a security force normally provided by the division. It warns of enemy approach and gives forward defense forces time to prepare the main battle area. Within its capability, the GOP delays, deceives, and disorganizes the enemy. It makes particular efforts to locate nuclear targets, and to deceive the enemy into presenting a nuclear target. It frequently allows the enemy to bypass some of its elements so they can provide intelligence information from behind the enemy lines, and so they can select vital targets and call for and adjust fire on them (par. 167).

b. The company, as part of the battalion on the general outpost line (GOPL) is normally assigned a wide frontage and a delaying action mission. It uses obstacles and demolitions extensively. Platoon positions should permit long-range fires and observation. Normally, the company cannot retain a platoon as a reserve.

c. As part of the general outpost, the rifle company may provide security elements forward of the GOPL.

d. The covering force has the mission of delaying the enemy forward of the GOPL for a specified period to provide time for the preparation of defensive positions, to disorganize the attacking enemy forces as much as possible, and to deceive the enemy as to the location of the FEBA. Forces assigned to a covering force carry out their mission primarily by means of delaying action as discussed in chapter 5.

122. Combat Outpost (COP)

a. The combat outpost is a security echelon, normally provided by the battalion, which is located from 1,000 to 2,400 meters forward of the battle area. It provides early warning of the enemy advance and denies him close ground observation of the battle area. Within its capabilities, it delays and disorganizes the enemy and deceives him as to the true location of the battle area. It avoids close combat.

b. The battalion commander usually prescribes the general location, control, and composition of the combat outpost. In some situations, the forward companies provide the forces for and control it. In other situations, the battalion reserve furnishes all troops for the combat outpost. They may be employed as a company under battalion control, or platoons may be attached to the forward companies. The combat outpost in front of each forward company usually consists of a reinforced rifle platoon. Preferably, the platoon is mechanized. Tanks are frequently attached to the company for use on the combat outpost. Tank sections may be attached to rifle platoons on the COPL. Artillery and mortar support is usually

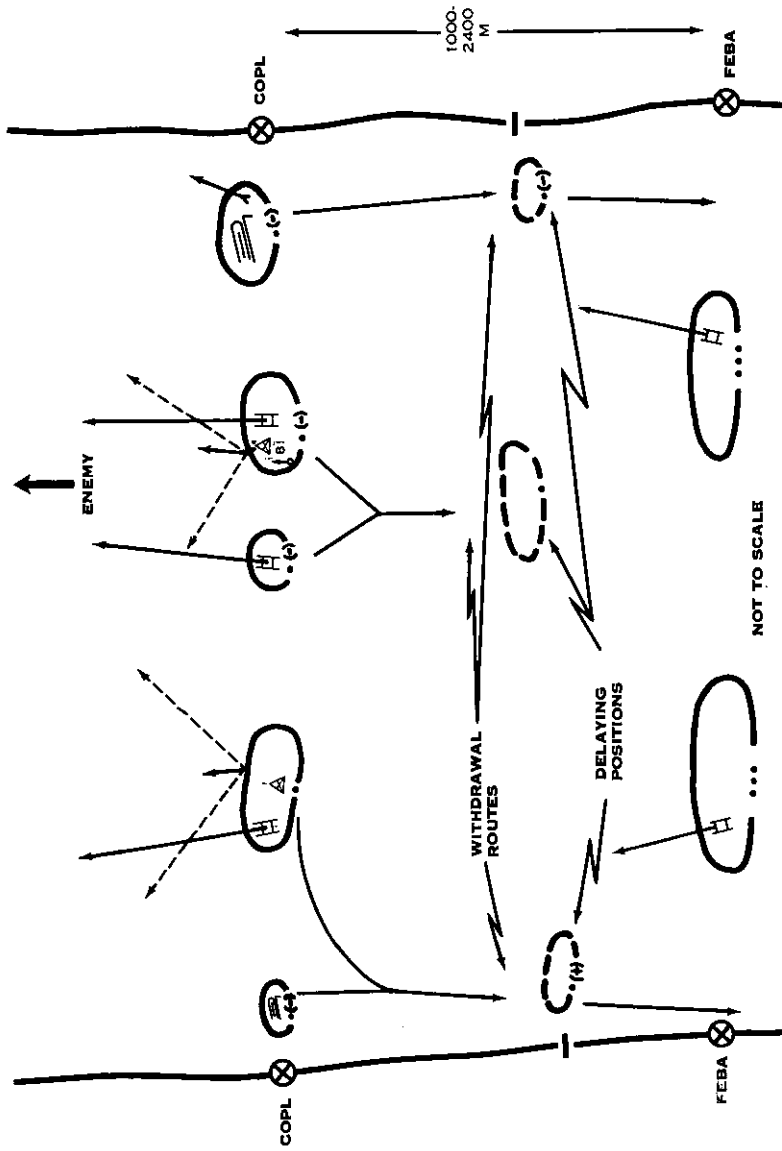

Figure 21. Type organization of a combat outpost (schematic).

provided from within the battle area ; however, a part of the 81-mm mortar section may be employed with the COP (FM 7-20).

c. The forces on the combat outpost line (COPL) are disposed laterally in one echelon in a series of outguards, varying in strength normally, from a fireteam to a reinforced squad (fig. 21). The outguards are positioned near the topographical crest, preferably on terrain which gives long-range observation and fields of fire. It may be necessary to place an outguard on less desirable terrain to cover a specific approach into the battle area. Preferably, adjacent outguards are within visual distance of each other. At night, the forces may have to be redispersed and/or additional security measures may have to be adopted.

d. Forward observers are employed with the combat outpost. The outpost commander plans fires well forward, immediately in front of, within, and to the flanks and rear. Fires are also planned to cover the movement of the COP along predetermined withdrawal routes.

e. The outpost commander provides security with sentinels, listening posts, warning devices, and patrols. When observation is limited, he uses visiting patrols between widely separated outguards. Following the withdrawal of, or in absence of a general outpost, he uses patrols forward of the combat outpost to gain and maintain contact with the enemy and to call for and adjust artillery and mortar fire. These patrols may be furnished by the combat outpost or by units (such as the reconnaissance platoon) of higher headquarters. Patrolling is normally intensified during periods of reduced visibility.

f. Plans are prepared for withdrawal of the combat outpost and are coordinated with elements along the FEBA. The withdrawal plan provides for delaying the enemy forward of the FEBA from one or more successive positions if the terrain permits. The withdrawal plan is designed to maintain contact so that any enemy withdrawal, which may indicate his intent to use nuclear weapons, can be detected. Prepared obstacles are used to assist in the withdrawal. Routes selected should permit the forces to withdraw without masking the fires of units along the FEBA. All personnel of the combat outpost are thoroughly familiarized with withdrawal plans.

g. As the enemy approaches the COPL, he is engaged by fires at long range. The fires are increased in intensity as he draws nearer. Patrols in contact with the enemy withdraw as required. Information of the enemy is continually reported to higher headquarters.

h. The authority to withdraw the combat outpost is normally delegated to the company commander. Based on information re-

ceived from the outpost commander, the company commander normally orders it to withdraw when it has accomplished its primary mission and before it becomes decisively engaged. The company commander informs the battalion and adjacent unit commanders of the contemplated time of withdrawal, then notifies them when the withdrawal starts and when it ends. If the combat outpost loses all communication with the company commander, the combat outpost commander may order it to withdraw to prevent its destruction. He makes every effort to notify adjacent units on the COPL and the company commander.

i. The techniques for conducting withdrawals and delaying actions are described in chapter 5. Elements of the combat outpost delay the enemy forward of the FEBA, within their capability, without becoming heavily engaged. If the enemy withdraws from the attack, the elements reoccupy the COPL and maintain contact with the enemy with patrols. If the enemy forces a withdrawal through the FEBA, weapons within the battle area cover the withdrawal with their fires. Those troops attached to the company for use on the COPL only, are released from attachment when they pass through the FEBA.

123. Security of Assembly Areas

A battalion or larger unit may detail one or more companies as assembly area security, however, every unit, regardless of size, is responsible for its own security. This security normally is provided by patrols and outposts. The elements on the outpost may be required to delay the enemy until the unit occupying the assembly area can deploy.

124. Security of Rear Areas and Installations

A rifle company or smaller unit may be detailed to protect rear areas and installations against attack by airborne forces, guerrillas, and infiltrators. Normally, the unit can provide this protection by establishing an observation and warning system, preparing necessary defensive positions, and by retaining the bulk of its strength in mobile reserve. The security detachments may vary in size from individual sentinels to reinforced squads. They may include sentinel posts, outguards, and foot, motorized, mechanized, or airmobile patrols. These detachments suppress minor disturbances and alert the mobile reserve to more serious threats. The mobile reserve is prepared to attack the hostile force or to defend the installations from prepared defensive positions.

125. Rifle Company Participation in the Mobile Defense

a. Employment in the mobile defense normally dictates that the rifle company be either mechanized or motorized. The company

may participate as a part of a battalion in the security forces forward defense forces (fixing forces) or the reserve (striking) forces. When the rifle company participates in the mobile defense the considerations for planning and conduct of the defense are essentially as outlined in paragraphs 126 through 143, with differences as outlined below:

- (1) Blocking positions may be organized at battalion (and, exceptionally at company) level for those battalions located in the forward defense area. Blocking positions are organized for all-round defense on key terrain which dominates an avenue(s) of approach or is located to canalize attacking forces. Alternate or successive blocking positions are designated in depth (see also, pars. 144-146).
- (2) Greater gaps exist between battalions (blocking positions) on the FEBA. Because of these greater gaps, there is an increased danger of enemy infiltration in strength. Under these conditions greater use is made of observation posts, listening posts, and patrols to cover the gaps between units.
- (3) In the mobile defense primary emphasis is placed on the offensive role of the division reserve to destroy the enemy.
- (4) Security for forward defensive forces is provided by a GOPL, observation posts, listening posts, and patrols. A COPL is not normally used in the mobile defense.

b. When the rifle company is employed as part of a battalion in a security force role on the division GOPL, it will organize and conduct its operations as outlined in paragraph 120.

c. When the rifle company is employed as part of a battalion in the forward defense forces of the division in a mobile defense, it will organize and conduct its operations as a delaying action, an area defense (pars. 126-143), (ch. 5), or some variation thereof. Regardless of how the defense is organized and conducted, the company must be positioned and prepared to fight and stay on its initial position if a change in the situation so requires.

d. When the rifle company is employed as the reserve of a battalion, the procedures outlined in paragraphs 153 through 156 will apply, except that the company will rarely be employed on the COPL since a COPL is seldom used in the mobile defense.

e. When the rifle company is employed as part of a battalion in the division reserve in a mobile defense, it will conduct offensive missions as described in chapter 3. As part of a reserve battalion, the rifle company may also organize defense areas within the division reserve area as required. (See also, FM 7-20.)

Section II. FORWARD RIFLE COMPANY—PLANNING THE DEFENSE

126. General

a. Guidance. The battalion commander furnishes enough guidance to insure that the company organizes and conducts the defense according to the battalion defense plan. He specifies whether the company is to defend its assigned area or is to defend initially and be prepared to withdraw to rearward defensive positions.

b. Boundaries. Company boundaries, which are extended forward and to the rear of the FEBA, indicate the area of company responsibility. When a company is responsible for the combat outpost, the boundaries are extended forward of the COPL to the limit of effective ground observation; otherwise, their forward extension does not include the COPL. The battalion commander may designate a company rear boundary to fully delineate the area of responsibility.

c. Coordinating Points. These points, which are designated on boundaries, serve two primary purposes. They indicate the general trace of the FEBA and the COPL (if appropriate) and they designate places on the ground where adjacent commanders coordinate their defensive plans to insure mutual support. Commanders (or their representatives) coordinate at the coordinating points and decide whether gaps should be covered by fire (direct or indirect), by obstacles and fires, or by outposts and/or patrols. Adjacent unit commanders who wish to relocate a coordinating point, may recommend the change to the commander who designated it. They may make mutually acceptable minor adjustments, but they must inform the next higher headquarters.

d. Battle Area. The area which a company can defend in any given situation is based on an estimate of the situation. For further general guidance see figure 22. It is emphasized that this illustration is to be used for general guidance and, under no circumstances, as a template to be applied to all situations.

- (1) The term "ideal defensive terrain" as used in the note affixed to figure 22 is defined as having—
 - (a) Excellent short- and long-range observation with no dead space and no natural concealment for the attacker.
 - (b) Excellent fields of fire such that machineguns and flat trajectory small arms are able to obtain grazing fire out to their effective ranges allowing units to obtain optimum mutual support.
 - (c) Terrain that provides concealed and covered routes in the company rear area, favorable for both resupply and shifting of troops.

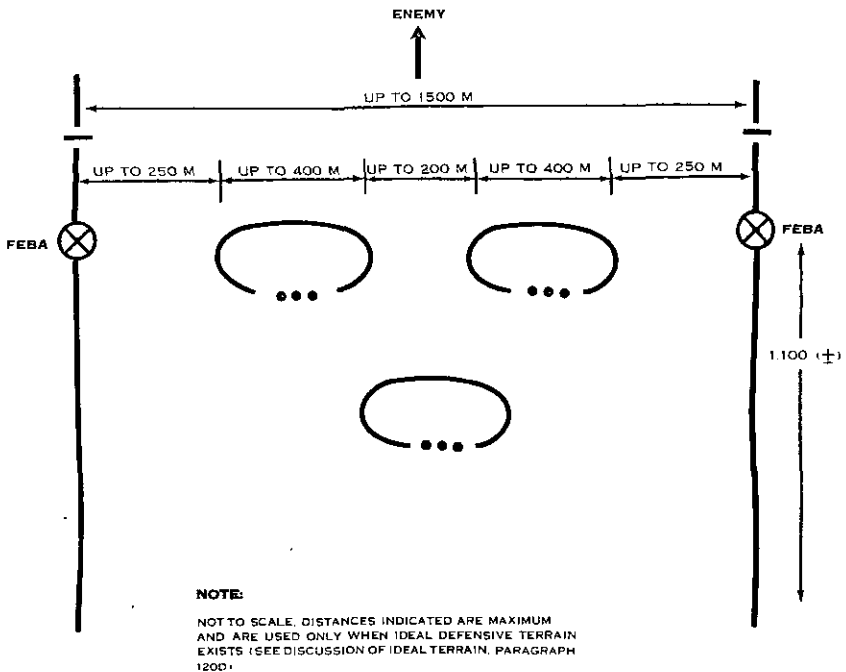

Figure 22. Rifle company defense (guide only).

- (d) Terrain to the front that has either natural obstacles or facilitates the preparation of artificial obstacles.
- (2) It is evident that such terrain is rarely available and that in defensive situations the rifle company must adjust to less favorable terrain and will defend on frontages less than the maximum indicated in figure 22.

e. Forces Employed on FEBA. Normally the rifle company employs two platoons forward and one in reserve. A reserve is desirable in order to provide depth and flexibility to the company defense area. Under certain circumstances, three platoons forward is necessary. In this event, the battalion commander usually places elements of the battalion reserve in position(s) to provide depth to the defense.

f. Formulation of the Defense Plan. The company commander develops his plan of defense based on his estimate of the situations (par. 14). He determines the disposition of his platoons and the use of supporting fires and obstacles concurrently, as these elements are interdependent. He applies the fundamentals of defense (par. 118) to best accomplish the assigned mission under existing conditions. See appendix II for troop leading procedure.

127. Surveillance and Security

a. The company commander establishes a surveillance system to operate day and night throughout the company area. It includes

the use of sentry and listening posts, observation posts, patrols, CBR detection devices, electronic surveillance devices, infrared or other night vision devices, trip flares and antipersonnel mines, noisemaking devices, aerial observers, and any other available means. The object of the system is to give early warning of enemy approach and to detect and report enemy infiltration and activity in the company rear area.

b. Normally the company commander has each platoon establish one or more observation, listening, or sentry posts. They are usually located no more than 500 meters forward of the FEBA. Security posts are established in the rear area, normally by the company reserve, and in the gaps between forward platoons. These security posts normally consist of two or more men and may be equipped with appropriate surveillance devices.

c. Organization of the FEBA may result in the existence of gaps between units. The rifle company can expect to provide patrols for surveillance of these areas. The primary mission of such patrols is to detect enemy infiltration attempts.

d. Patrols are also used forward of the FEBA, and in the company rear area primarily to cover areas not otherwise under surveillance. They normally operate at irregular intervals over a variety of routes to avoid establishing a pattern of operation.

e. An adequate communication system is essential to the functioning of the surveillance system. Alternate means of communication must be provided.

f. For employment of the ground surveillance section, see appendix IV.

128. Employment of the Rifle Platoon

a. Normally the company organizes its defense on the forward slope, but it may use the reverse slope (pars. 147-149) or a combination of forward and reverse slope areas when the situation requires.

b. The company commander analyzes terrain and assigns platoon areas which dominate avenues of approach and protect key terrain features. He considers the frontage each platoon is capable of defending under existing terrain conditions. He does not divide responsibility for defending an avenue of approach, but assigns the approach and terrain that dominates it to one platoon. He retains a company reserve to add depth to the area and flexibility in the conduct of the defense, consistent with requirements for providing adequate forces to defend the FEBA (fig. 23).

c. If the terrain assigned to the company requires all the rifle platoons to be employed on the FEBA, the company commander selects supplementary positions to protect his flanks and rear. He

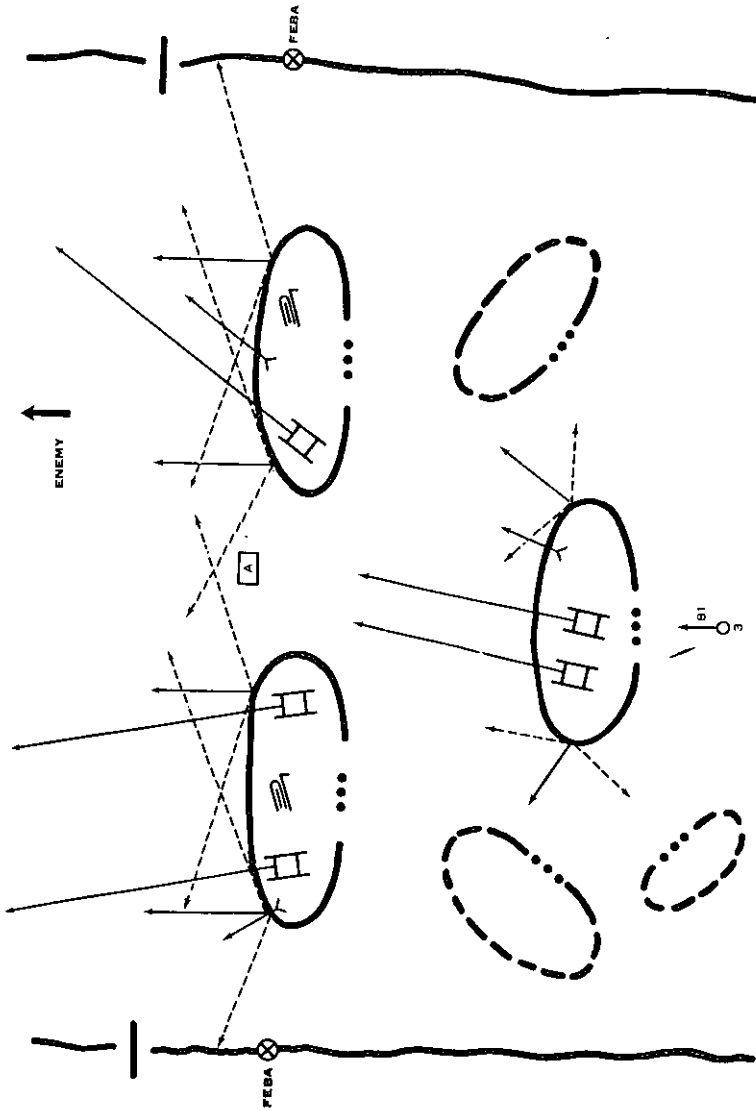

Figure 23. Company defense area, two platoons on FEBA (schematic).

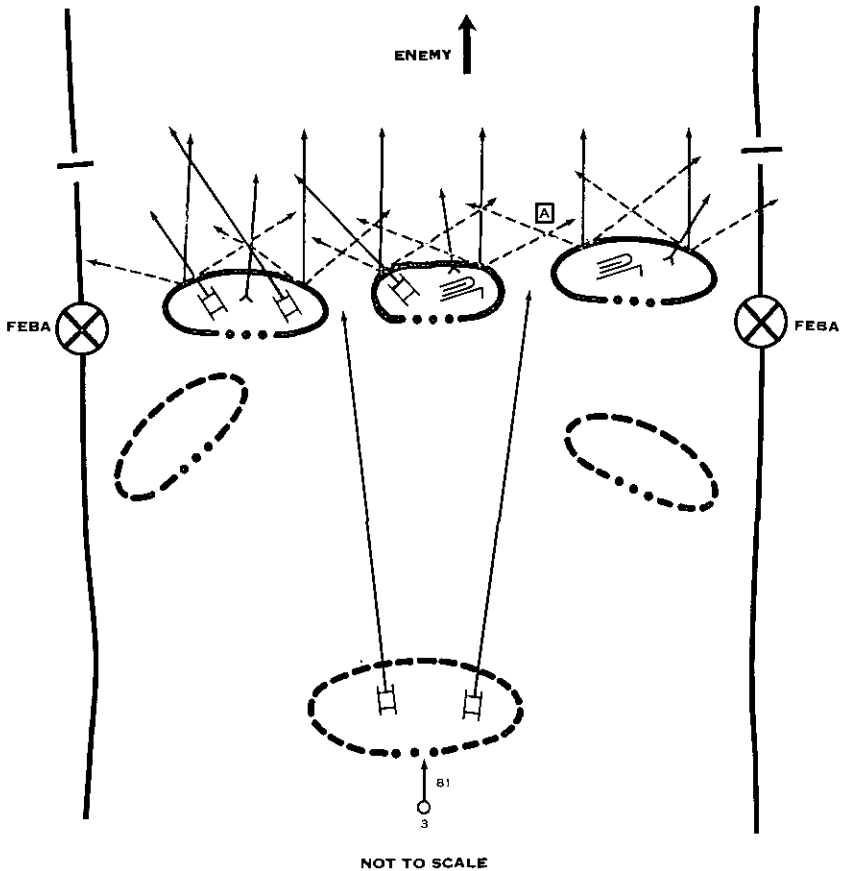

Figure 24. Company defense area, three platoons on FEBA (schematic).

may shift forward platoons to these positions to counter such threats (fig. 24).

d. The reserve platoon is normally positioned to provide depth to the company area. It protects key terrain features in the company rear and/or controls the most dangerous approach(es) through the company area. Appropriate missions for the reserve and its employment are described in paragraph 137. When the reserve platoon is assigned the mission of supporting the forward platoons by fire, it should be located within 500 meters of these platoons though it should be at least 150 meters to the rear of their supplementary positions. He designates supplementary platoon positions as necessary to protect the flanks or to control other terrain or approaches that cannot be controlled from the primary position.

e. The company commander preferably assigns platoon areas by indicating to each platoon leader, on the ground, his area of

responsibility, the trace of the FEBA, and the flanks of adjacent platoons to permit coordination of fires. When time is limited, he may point out these locations on a map. Boundaries and coordinating points are rarely designated between platoons.

f. Daylight dispositions may not be suitable during periods of reduced visibility. Gaps between forward platoons, which can be covered by observed fire during daylight, may have to be occupied or patrolled at night. In other situations, daylight dispositions may have to be adjusted at night to form a more compact company defense. Plans for the redistribution of platoons must insure adequate surveillance and fire coverage of the increased gaps on the flanks. Normally, these plans must be approved by the battalion commander.

129. Employment of Organic Weapons and Attachments

a. *General.* Weapons organic and attached to the rifle company may be employed in general support or direct support of the company or they may be attached to subordinate units. The method selected for a given situation should provide for maximum support, the greatest possible flexibility, and the most effective control that can be achieved.

- (1) *General support.* General support requires the firing unit to provide support to all, or the major portion, of the company. The company commander retains overall control of the fires and movement of the unit. He designates initial target areas, specifies general position areas, and controls displacement. He controls the unit through its leader who selects specific weapons positions, controls the fire, controls the unit during displacement, and insures that it is resupplied. The desirable characteristics of general support include flexibility in massing and shifting fires, continuity of support, ease of control, and simplicity of resupply.
- (2) *Direct support.* When a fire support element is in direct support of a unit, it is responsible for delivering its fires in support of that unit. When the supported unit does not require its fires, it may honor other fire requests. The direct support unit leader selects firing positions and controls displacement in order to provide the support desired. Direct support is seldom employed at rifle company level.
- (3) *Attachment.* When one unit is attached to another, its control, tactical employment, and the responsibility for its administrative support passes from its parent unit to the commander of the unit that receives the attachment. When fire support elements are attached to the rifle company, the company commander may use them in

general or direct support, or he may further attach them. For example, he may attach elements to a rifle platoon when the platoon is to operate beyond effective range of the weapons if retained under company control, or when the platoon must operate over terrain whose configuration makes it mandatory for the fire support weapons to accompany the platoon.

b. 81-mm Mortar Section.

- (1) Whenever possible, the 81-mm mortars are employed in general support. It is desirable that they be able to support all forward rifle platoons from one position area. Exceptionally, the forward rifle platoons may be too widely separated for the mortars to be used in general support. In this case, one or more squads may be attached to forward platoons while the rest are used in general support.
- (2) When the company is responsible for the COPL, the mortars may frequently be positioned well forward initially, a short distance back of the FEBA, to provide adequate support for the combat outpost. If this does not give adequate support, one or more squads may be attached to the combat outpost.
- (3) When the mortars are employed in general support, the company commander designates a general position area for them, based on the recommendation of the weapons platoon leader.

c. Antitank Section.

- (1) Whenever possible, the antitank section is employed in general support for flexibility in moving the weapons throughout the company area to meet armor threats. When the terrain does not permit free movement, one or both squads may be attached to rifle platoons.
- (2) One or both squads may be attached to the combat outpost.
- (3) When the antitank section is employed in general support, the company commander assigns each squad a general position area and a principal direction of fire, based on the recommendation of the weapons platoon leader.

d. Tanks. Tanks and mechanized flamethrowers may be attached to the forward company. The company commander normally retains them in general support to permit flexibility in their employment during the conduct of the defense. When the tanks are employed in general support, the company commander assigns

each a general position area and principal direction of fire, based on the recommendation of the tank unit leader.

e. Davy Crockett. Davy Crockett will normally be employed in general support of the battalion or in direct support of the company (FM 7-20).

130. Employment of Armored Personnel Carriers

a. When the company mission calls for a withdrawal and delaying action to subsequent defensive positions, the APC are not organic, the battalion commander may attach enough APC to mechanize the entire company.

b. In the mechanized infantry rifle company (infantry and airborne infantry when completely mechanized) APC may be placed in hull defilade positions to support by fire; they may be positioned to provide security to the flanks and rear; or they may be held in covered and concealed positions in rear of the forward platoons until time for the move. The primary purpose of the APC is to provide armor protected mobility and they should not be placed in firing positions if they will be unduly exposed to antitank fire or air attack.

- (1) When used in firing positions, the APC should be in hull defilade so that only the machinegun is visible from the front. The platoon leader will assign each a sector of fire that supplements other fires. The APC driver normally fires the machinegun. If the APC are used to cover the flanks and rear, they take advantage of all available cover and concealment. The platoon leader will select alternate and supplementary positions and routes to them.
- (2) If the APC are placed in a covered and concealed area, it should be close to the platoon area (normally the first suitable area in rear of the platoon position). The APC are dispersed and positioned to provide all-round security. Normally the platoon will not provide additional security to the APC.
- (3) APC are camouflaged as soon as possible. Track marks that will disclose their positions are obliterated. Time permitting, the APC may be dug in or protected with sand bags, though not to an extent that prevents them from moving quickly.
- (4) At night the APC may be moved from rear areas to the platoon area for security or to provide additional fires.

c. In the infantry and airborne infantry rifle companies, when only enough APC are attached to mount a portion of the company, the company commander normally will attach APC to the combat

outpost until it withdraws. He may then attach them to the reserve so that it can more easily perform rear area surveillance or make a protected move to supplementary positions. He may retain them under company control to be employed as dictated by the situation, or he may attach them to the forward platoons when he anticipates having to move the platoons. In making his decision on their employment, the company commander considers the number of APC attached, the mission, plan for conduct of the defense, terrain in the area of operations, contaminated areas to be crossed, enemy mobility and armor capability, enemy air capability, and security requirements. The firepower of the machineguns mounted on APC is not a primary consideration in making his decision.

131. Communications

a. The company installs a complete wire system to control its units and fires. Wire communication is preferred to radio because it is more secure. Nevertheless, the company establishes a complete radio net and, usually, keeps the radios on listening silence for use in the event there is a wire failure. During movement to supplementary positions, radio will be a primary means of communication until wire communication is established.

b. Unless otherwise specified, a unit is responsible for maintaining contact with the unit on its right. The company commander normally specifies the action to be taken by the right forward platoon concerning contact with the right adjacent company (par. 21).

132. Fire Support Planning

a. General. Fire support planning in the defense involves the preparation of a coordinated fire support plan designed to bring the enemy under fire as soon as he comes within air or ground observation (long-range fires), to hold him under an increasingly heavy volume of fire as he approaches the battle area (close defensive fire), to stop his assault by an intense barrier of fire immediately in front of the battle area (final protective fire), to destroy him by fire if he penetrates the battle area, and to support counterattacks (fires within the battle area). The plan includes fires of organic, attached, and supporting weapons on targets of opportunity, and prearranged fires that can be delivered under any condition of visibility. The fire support plan is coordinated with the barrier plan to provide fire coverage of obstacles. (For further details on fire support planning, see FM 7-20.)

b. Barrages.

(1) Barrages are prearranged barriers of fire designed to stop or destroy the enemy forward of the FEBA. They

are coordinated with other direct and indirect fires and with artificial and natural obstacles. Barrages are fired by mortars and artillery and are a part of final protective fires. Normally, barrages are planned to cover dangerous avenues of approach into the area to break up an enemy assault against friendly positions on the FEBA. They are usually planned so that the near edge of their impact area is as close as practicable to the FEBA and in no case more than 200 meters forward of the FEBA. Barrages take priority over all other fire missions. Artillery barrages are fired on order of the company commander in whose area they are located and, when delivered, are fired continuously at maximum rate for a specified time or until ordered discontinued by the company commander. A barrage may be repeated on-call, if necessary. Only one barrage is assigned to a firing unit.

- (2) The widths of barrages of various weapons are shown below. The widths may be increased when necessary, but the effectiveness of the fire will be decreased proportionately. A depth is not normally assigned to a barrage.

<i>Weapon</i>	<i>Unit</i>	<i>Width of barrage</i>
81-mm mort	squad	*50 meters
81-mm mort	section	100 meters
4.2-in. mort	squad	50 meters
4.2-in. mort	2 squads	100 meters
4.2-in. mort	mortar section (4 squads).	180 meters
105-mm how	battery	200 meters
155-mm how	battery	300 meters

* This width cannot be increased.

- (3) The battalion commander designates the general location of the barrages of the mortar section and of the direct support or reinforcing artillery. The company commander in whose area the barrage is located specifies its exact location to the artillery/mortar forward observer and reports the right and left limits of the barrage line to the battalion commander.
- (4) Based on recommendations of the weapons platoon leader, the company commander either assigns each 81-mm mortar squad a barrage (50 meters) or assigns the entire section a barrage (100 meters) to cover approaches into the company area that are not covered by heavier barrages, or to add to the coverage of heavier barrages.
- (5) When a rectangle is used to show a barrage graphically, the barrage line (center of impact) within the rectangle is the line joining the midpoints of the sides.

c. Concentrations. Concentrations for indirect fire weapons are planned to engage enemy targets throughout the company area of responsibility, both forward and in rear of the FEBA. They may include fires to support the combat outpost; to cover avenues of approach, areas which direct fire weapons cannot reach, gaps between platoons, and other likely target areas; to limit penetrations; and to support counterattacks.

d. Antitank Defense.

- (1) All antitank defenses, to include both weapons and measures should be integrated and to the extent practicable, be mutually supporting.
- (2) The company commander employs the antitank section, attached tanks, and ATGM to cover likely armor approaches into the company area. He plans for fires of these weapons to engage enemy armor as soon as it comes within effective range. These elements should be located so they can provide antitank protection laterally and in depth. The antitank squads are normally positioned in the forward platoon areas to take maximum advantage of their range; however, one squad may be positioned in depth when other antitank means are limited. The antitank squads are normally employed singly, so each can cover a separate approach. Alternate positions are selected for use when primary positions become untenable. Supplementary positions are selected to cover armor approaches not covered from primary or alternate positions. Since the ATGM may be launched from the vehicle or ground, squads may emplace additional missiles to cover all possible tank approaches.
- (3) Tanks and antitank weapons may be employed in the company area under battalion control, in which case the antitank weapons under company control are positioned to complement their fires.
- (4) Each rifle platoon leader places his weapons squad's antitank weapon(s) where it can cover the most dangerous armor approaches into the platoon area (after considering the protection offered by other antitank weapons).
- (5) The rocket launchers of company headquarters normally provide antitank protection for the company rear area as directed by the company commander.

e. Small Arms Fire. In addition to the small arms fire coverage provided by the assignment of platoon areas of responsibility, the company commander may specifically direct fire coverage of particular areas, such as gaps between platoons. He may require these areas to be covered by machinegun fire. Normally, however,

the machineguns are employed by the rifle platoon leaders. The machineguns on personnel carriers may supplement other fires. (See also par. 130.)

f. Flame. Portable or mechanized flamethrowers and flame field expedients may be used to provide close-in support. See FM 20-33 for detailed discussion on fabrication and employment of flame weapons and expedients.

g. Nuclear Fires. The company commander's responsibility for planning nuclear fires is the same as for any other fire support means. Decisions concerning the employment of nuclear weapons allocated to the company rest with the company commander within restrictions imposed by the battalion commander. The company commander must insure that both nuclear and nonnuclear fires are completely integrated. He does this whether the nuclear fires are specifically controlled or requested by him or are planned and directed by higher headquarters.

h. Weapons Platoon. For a detailed discussion of the employment of the weapons platoon, see paragraph 138.

i. Disposition of Fire Support Plan. The company fire support plan is forwarded to the battalion commander for integration into the battalion fire support plan. Subordinate leaders are informed of the fires available to them for the defense.

133. Barrier Planning

a. The barrier plan is originated by higher headquarters. It is a coordinated series of obstacles which canalize, restrict, delay, or stop enemy ground movement. The use of barriers and obstacles is coordinated closely with the fire plan, disposition of units, and plans for the movement of friendly forces during the defense. Care must be taken in planning the barrier systems to avoid interfering with the rapid shifting of units. Barriers and obstacles are planned forward of the FEBA to delay or canalize enemy movement, and within the battle area to limit penetrations, to provide a degree of flank protection, and to canalize the enemy into areas favorable to the defender.

b. A barrier plan contains applicable portions of barrier plans of higher echelons. It also contains detailed instructions to subordinate units concerning the location and purpose of each barrier and the responsibility of subordinate units for constructing specific obstacles that will make up the barrier.

c. Obstacles are most effective when covered by fire (FM 31-10). Care must be taken to provide enough gaps and lanes in the barrier system to permit friendly forces to patrol and counter-attack.

d. An obstacle, either natural or artificial, should be exploited to the maximum in organizing an area for defense. Artificial

obstacles are used to extend or supplement natural obstacles, if possible. The battalion or higher headquarters generally coordinates the use of extensive obstacles such as antitank ditches and minefields.

e. Barbed wire entanglements are classified as tactical, protective, and supplementary, depending on their use. *Tactical wire* entanglements are designed to break up attack formations and to hold the enemy in areas covered by the most intense defensive fires. They are normally sited along the friendly side of machine-gun final protective lines. They may extend across the entire front of a position but are not necessarily continuous. *Protective wire* entanglements are located to prevent surprise assaults from points close to the defensive positions. They are close enough to be observed day and night and far enough away to keep the enemy beyond normal hand grenade range. *Supplementary wire entanglements* are used primarily to break up the pattern of tactical wire, thus deceiving the enemy as to the location of final protective fires. They are also used to connect platoon and company defensive areas and to canalize the enemy into areas of intensive fires.

f. The battalion commander may authorize the company commander to lay protective minefields (antipersonnel and antitank mines) across likely avenues of approach within the company area of responsibility. These minefields provide local protection against infiltration and small unit armor or infantry attacks. Mines are laid in standard or nonstandard patterns and are covered by fire. Antipersonnel mines are placed far enough from the position to keep the enemy out of hand grenade range. The mines may either be buried or concealed on top of the ground. They are placed so they can be rapidly removed by the installing unit. Standard or improvised trip flares or other warning devices may be used to give warning of enemy approach. The company commander is responsible for laying, marking, recording, and reporting the mines; for removing or transferring the minefield, when necessary; and for coordinating with friendly troops who may enter or pass through the minefields in his area (FM 20-32).

g. The use of toxic chemical contamination as part of the barrier plan is normally directed and coordinated by a higher headquarters. The company may be required to cover such areas by fire.

134. Counterattack Planning

a. A counterattack is a limited objective attack designed to destroy or eject the enemy from an area of penetration and to regain lost portions of the battle area. The company has no counterattack capability if all platoons are employed on the FEBA.

The reserve platoon usually blocks to limit a penetration; however, in anticipation that proper conditions may develop, the company commander plans for the use of the reserve platoon to counterattack.

b. In his planning for the counterattack the company commander assumes likely penetrations of the FEBA and plans a counterattack to reduce each. He assumes the penetrations will include or threaten key terrain features and will be of such size that they can be contained by the forward platoons. Such assumptions are necessary to permit or justify a counterattack at company level.

c. Each counterattack plan is developed generally like any plan of attack, as discussed in chapter 3. The maneuver element is normally the reserve platoon and any attached tanks that may be disengaged and used as a part of the maneuver element. The plan consists essentially of control measures such as a line of departure and the route to it, a direction of attack, an objective, and a fire support plan. The LD selected during the planning phase is normally along the line of contact for the assumed penetration. The attack is preferably directed at the flank of the penetration, with the maneuver elements avoiding friendly positions. Fires from these positions are used to the maximum to assist the maneuver element.

d. All subordinates are informed of counterattack plans and the plans are rehearsed if time permits. Leaders make necessary reconnaissance.

Section III. FORWARD RIFLE COMPANY—ORGANIZING THE DEFENSE

135. Priority of Tasks

a. Many of the tasks involved in organizing a defensive position are carried on concurrently, but some may require priority. The company commander therefore specifies the sequence for the preparation of the position and any special precautions to be taken regarding camouflage. The following is a recommended sequence:

- (1) Establishing security.
- (2) Positioning weapons.
- (3) Clearing fields of fire, removing objects masking observation, and determining ranges to probable target locations.
- (4) Providing signal communication and observation systems.
- (5) Laying minefields and preparing important demolitions.
- (6) Preparing weapon emplacements and individual positions, to include overhead cover, and camouflaging them concurrently.

- (7) Preparing obstacles (other than minefields) and less vital demolitions.
- (8) Preparing routes for movement and for supply and evacuation.
- (9) Preparing alternate and supplementary positions.
- (10) Preparing CBR protective shelters as required.
- (11) Preparing deceptive installations in accordance with deception plans of higher headquarters.

b. The organization of the ground begins as soon as the troops arrive in the area and continues as long as the position is occupied. When it must be organized while the force is in close contact with the enemy, defense against attack may be required during any or all stages of the organization. Maximum use is made of available fires to cover the organization, and smoke may be used to deny the enemy observation of the preparation of positions.

136. Organization of a Forward Platoon Defense Area

The company commander assigns the forward rifle platoon an area to organize and defend. The platoon need not occupy all of the area. It organizes the best defensive terrain within it and covers the unoccupied portion by fire. The area is organized for all-round defense and to provide mutual support with adjacent platoons. The frontage a platoon can occupy and the area it can defend are determined primarily by the mission, enemy, terrain and weather, strength of the platoon, and the number of non-organic weapons (such as tanks and antitank weapons) located in the platoon area. For a guide only, see figure 25.

137. Reserve Rifle Platoon

a. The reserve platoon(s) is normally placed behind the forward platoons to provide depth to the company defense area (par. 128).

b. The company commander assigns the reserve platoon a primary position and one or more supplementary positions. He specifies the order in which the supplementary positions will be prepared. He further assigns the reserve one or more missions and states the priority for accomplishing each. Appropriate missions are to—

- (1) Limit penetrations.
- (2) Protect the company flanks and rear.
- (3) Support the forward platoons by fire.
- (4) Perform surveillance in the company rear area and provide security.
- (5) Participate in a counterattack.

c. If the company is responsible for furnishing troops for the COP, the reserve platoon is normally assigned this mission. This

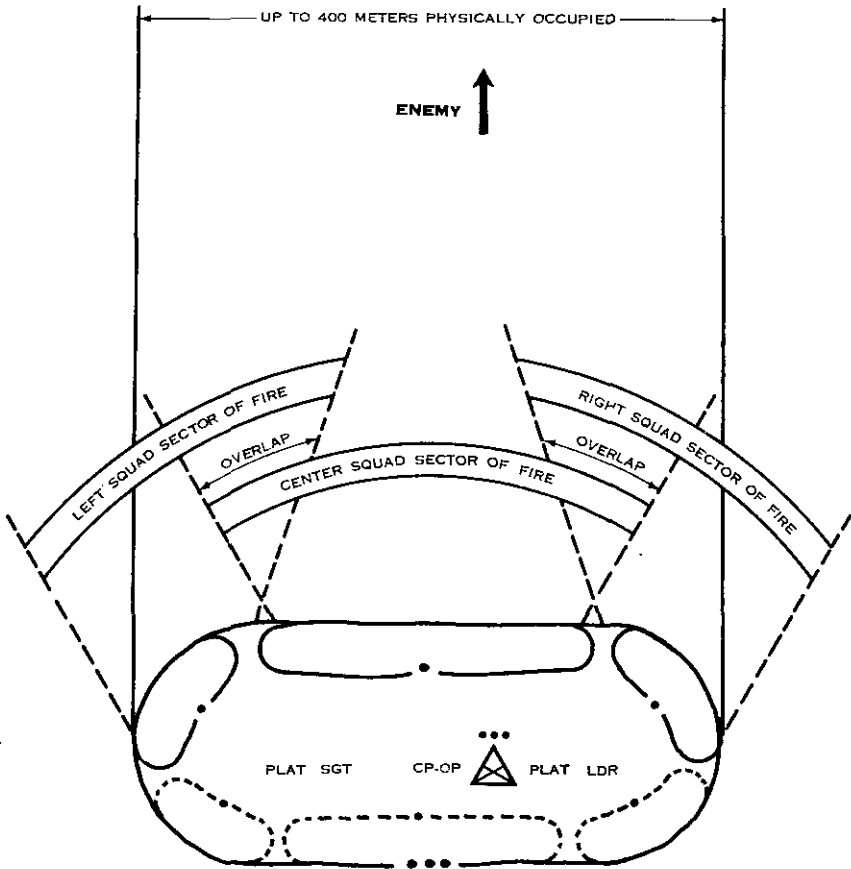

Figure 25. Typical dispositions of a forward rifle platoon (schematic).

allows the forward platoons to use all their personnel to prepare their positions on the FEBA which permits the withdrawing combat outpost to pass through units in prepared positions. While the reserve platoon is on the COPL, the company commander has other elements of the company prepare reserve platoon positions, if at all possible. For a discussion of the combat outpost, see paragraph 122.

d. The organization of a reserve platoon position is generally the same as for a forward rifle platoon (par. 136), except that final protective fires are not planned. The entire platoon normally occupies its primary position. When the terrain makes it hard for the reserve to move to supplementary positions, it may have to organize and occupy more than one position initially. If so, the integrity of the rifle squads is maintained, though the weapons squad may be divided.

e. The company commander designates the position to be occu-

pied by the reserve platoon. He may order the platoon to move from one position to another as required by the enemy situation. In supporting the forward platoons by fire, the reserve platoon may fire into the gaps between platoons and at any enemy attempting to attack the forward platoons from the rear.

f. When the company commander assigns security and surveillance missions for the reserve he normally states them specifically and he may direct the reserve to establish sentinel or listening posts forward of, in rear of, and in the gaps between forward platoons, or he may order it to patrol throughout the company area and to maintain contact with adjacent units. For additional discussion of security and surveillance, see paragraph 127.

g. Due to its limited counterattack capability, the reserve platoon is rarely committed in a counterattack role. When assigned this mission, the reserve platoon leader prepares plans for his platoon to implement company counterattack plans. He may assist the company commander in preparing the counterattack plans. A counterattack plan is essentially the same as any attack plan (pars. 47-116 and 134). All leaders of the reserve are thoroughly oriented on counterattack plans. The plans are rehearsed if time permits. For conduct of the counterattack, see paragraph 143.

138. Weapons Platoon

a. *Missions and Employment.* The primary mission of the anti-tank section is to provide antitank protection for the company. A secondary mission is to reinforce the fires of the other weapons located on the FEBA. The 81-mm mortar section provides close and continuous fires to the company. It accomplishes this mission by firing concentrations in support of the combat outpost (if appropriate), firing concentrations both forward of and in rear of the FEBA, and firing barrages. For the employment of the anti-tank and mortar squads, see paragraphs 129 and 132.

b. *Actions of the Platoon Leader.* The weapons platoon leader normally goes with the company commander to receive the battalion defense order. He may go with the company commander on his reconnaissance, or he may make a separate reconnaissance. He prepares recommendations on the employment of his platoon (pars. 129 and 132). If general support appears to be feasible, he prepares recommendations on general position areas, to include alternate and supplementary positions; the disposition of forward observers; the principal direction of fire for each antitank squad; and the location of 81-mm mortar barrages and concentrations.

c. *Mortar Fire Planning.* As soon as possible, the platoon leader coordinates with the artillery FO and/or mortar FO and, assisted by the mortar section leader, prepares a mortar fire plan. Based

on instructions from the company commander, he plans 81-mm mortar barrages and concentrations. He plans concentrations on likely target areas both forward of and within the battle area and to support any counterattacks (par. 129). He submits this plan to the company commander for approval. When approved, it is normally prepared in overlay form and distributed to the mortar and artillery forward observers and rifle platoon leaders.

d. Selection of Mortar Positions. Based on the general position area directed by the company commander, the section leader normally selects the position area for the squads, leaving the selection of the exact site for each mortar to the mortar squad leader. Usually the three squads are located in one general firing position area. In selecting the firing positions, the section leader considers the provision of maximum coverage for the company area; the maximum and minimum close support ranges of the mortar; defilade; concealment; mask and overhead clearance; room for dispersion between squads; firm ground to support the base plate; routes for ammunition resupply; and security which may result from locating the position near a reserve platoon area. See paragraphs 129 and 132.

e. Selection of Antitank Squad Positions. The antitank squad leader normally selects the exact firing position for his weapons, based on instructions from the platoon leader or antitank section leader. Observation and fields of fire forward of the position are essential. Backblast clearance is always considered. It is desirable, whenever the terrain and tactical situation permit, to select a position from which the squad can reinforce fires of other weapons along the FEBA as well as perform its primary antitank mission. The ATGM is employed on the vehicle whenever possible, from partial defilade. Enemy action may make it necessary to place the weapon in defilade and necessitate the use of the ground control equipment. The squad leader selects a number of alternate positions so the vehicle can move frequently while engaging enemy armor.

f. Rocket Launchers. The platoon leader employs his two organic rocket launchers to furnish close-in antitank protection, usually for the mortar squads. He specifies a principal direction of fire for each launcher.

g. Communications and Control. The elements of the weapons platoon employed in general support are controlled by the company commander through the weapons platoon leader. The platoon leader positions himself where he can best help to control the elements of his platoon, or as the company commander directs. Wire is used to the maximum extent possible to communicate with the antitank squads, the FDC, and the forward observers. The wire

system is supplemented by radio and by the wire facilities of the rifle platoons. The FDC is normally located close enough to the mortar positions so that commands may be given by voice, but wire facilities are available and may be used if required.

h. Ammunition Resupply. See paragraph 66a(4).

i. Forward Observers and Observation Posts. One forward observer party is normally attached to each forward platoon while the remaining FO's occupy observation posts as directed by the weapons platoon leader. The observers adjust fire and, as a secondary mission, report information concerning the enemy. Mortar observation posts should give maximum observation of the approaches into the company area. When a mortar squad is attached to a rifle platoon, one FO party and one fire direction computer accompany the squad. The weapons platoon leader may establish a platoon OP to supplement the observation of the forward observers with the rifle platoons. He, or any member of the platoon who can adjust mortar fire, may operate the platoon OP.

j. Organization of Positions. As the squads arrive at their assigned areas, each squad leader places his squad in a temporary firing position where it can cover its assigned sector or principal direction of fire. The squads then work on their primary positions. The weapons are moved to the completed, camouflaged primary firing positions, and the platoon leader checks them at his earliest opportunity.

- (1) *Antitank squads.* Emphasis is placed on clearing fields of fire and providing backblast clearance. After the primary squad position is prepared, the squad leader examines it from the direction of the enemy to check on the camouflage and concealment. The squad then determines the ranges to the most likely target areas and prepares a range card. Finally, the squad prepares alternate and supplementary positions.
- (2) *81-mm mortar section.* After the primary mortar positions are completed, the squads emplace their mortars and begin registration. Normally, they first register barrages, then the concentrations farthest from the battle area. Coordination in registration is necessary to avoid endangering security and reconnaissance elements and work details forward of the battle area. The fire direction center maintains a firing data sheet with the data necessary to fire each barrage and planned concentration. The mortar squads prepare alternate and supplementary positions.

139. Command and Administrative Installations

a. Observation Post (OP). The company commander selects an observation post, normally in a forward platoon defense area. It should give the best possible view of the company defense area, its flanks and approaches. It is manned at all times by personnel of company headquarters, who report all enemy information. The commander may establish more than one observation post to provide observation over the entire company area of responsibility. Although the observation post is the company commander's battle station, he goes where he is needed. He keeps the command post informed of his location.

b. Command Post (CP). The command post is set up in the rear portion of the company battle area. It is located preferably in a defilade position that is concealed from air and ground observation. Concealed and covered routes to the front and rear are desirable to facilitate communication and supply. A covered and concealed shelter should be constructed whenever practical to assure uninterrupted operations under enemy attack. The command post normally provides its own security. Additional security may be obtained by locating it near a reserve platoon position. Personnel must be present in the command post at all times. A company aid post will be established in the general vicinity of the command post, for the temporary care of casualties awaiting evacuation.

c. Company Trains. See paragraph 33.

Section IV. FORWARD RIFLE COMPANY—CONDUCT OF THE DEFENSE

140. General

This section deals with the conduct of the defense of a forward rifle company whose mission is to defend its assigned area.

141. Conduct of the Defense During Daylight

a. The conduct of the combat outpost is described in paragraph 122.

b. All leaders and forward observers search for targets for indirect fire weapons and call for and adjust their fire. Tanks and antitank weapons open fire on appropriate targets when the enemy comes within effective range. If it appears the enemy knows the location of the FEBA, all weapons along the FEBA open fire as he comes within their effective range. If it appears that the enemy is probing to locate the defense positions, all but a few specified fires may be withheld until he is well within effective rifle range, then all weapons along the FEBA engage appropriate targets

within their sectors of fire. If the enemy attacks without armor, the defender's tanks and antitank weapons may engage such targets as crew-served weapons, vehicles, and groups of personnel. Leaders actively control the fires of their units to insure that all fires are effective. They move their weapons to alternate or supplementary firing positions as required.

c. The rate of fire increases as the enemy approaches the FEBA. If the attacking force includes tanks as well as infantry, the tanks are engaged by antitank weapons and medium artillery, while small arms fire and light artillery are directed at the attacking infantry. Every effort is made to separate the tanks and infantry. The company commander moves his antitank squads and attached tanks to supplementary positions to reinforce the fires in a threatened area as required. If the infantry attack is repelled but the tanks continue to advance, small arms fire is directed at tank periscopes and exposed tank crewmen.

d. If the enemy is repelled, he is pursued by all available fire. If he breaks contact, units in the battle area reestablish local security and send patrols forward to regain contact. The defender delivers harassing and interdiction fires in areas where the enemy is likely to be regrouping. The FEBA is reorganized as soon as possible.

e. During the conduct of the defense, all leaders keep their next higher commander informed of the situation at all times. Aggressive leadership on the part of all leaders is essential. Fire team leaders assist their squad leaders in the control of the squads, particularly in fire control. Squad leaders normally do not fire their weapons except during close-in defense action. The weapons squad leader controls all or a portion of his weapons or assists the platoon leader as directed. During the conduct of the defense, leaders move from place to place so they can influence the action through personal leadership.

f. If the enemy continues his advance through the close defensive fires, the platoon leader in the threatened area calls for the final protective fires for his defensive position. The platoon delivers maximum fires along with the barrages and machinegun final protective fires. Automatic riflemen and riflemen fire within their sectors except when directed otherwise by their fire team leaders. If possible, elements of the flanks reinforce the fires of the platoon under assault. Mechanized flamethrowers engage the enemy. The company commander calls for the fires of indirect fire weapons that are not firing barrages, to reinforce the fires in the threatened area.

g. If it appears that a penetration of the company's sector of the FEBA is probable, the commander moves the reserve to sup-

plementary positions from which it can block the penetration and/or support threatened units by fire. If the penetration or threat is in the area of an adjacent company, he positions his reserve to protect the endangered flank.

h. If the enemy assault reaches the position, the defender repels him using every means available. All weapons engage appropriate targets. Individuals along the FEBA continue firing until forced to take cover to protect themselves and their weapons from the crushing action of tanks. They resume their firing positions and continue to fight as soon as the tanks pass. Tanks that penetrate the forward area are engaged by the antitank weapons that are positioned in depth.

i. If the platoon area is penetrated or if it is threatened from the flanks or rear, the platoon leader may adjust his defenses by moving men and weapons from the least engaged area into supplementary positions to meet the threat. If it becomes necessary, the company commander can improvise a reserve from available personnel and use it to reinforce the threatened area. He calls for the fires of all weapons that can profitably engage targets within the penetration. If organized resistance within the penetrated area has ceased, the company commander may call for indirect fires to be placed in the area. Fires are also placed across the base of the penetration to prevent the enemy from reinforcing it.

j. The company normally attempts to limit a penetration of the forward platoons with the reserve and to destroy the enemy by fire. It relies on a higher echelon to eject the enemy by counter-attack. Exceptionally, the company may counterattack (par. 143).

142. Conduct of the Defense at Night

a. At night, the company relies on patrols, listening posts, and surveillance devices to detect an advance or infiltration. If the company reduces the size of the defensive position at night (par. 129f), it must insure surveillance of the gaps created on its flanks.

b. The security elements report the advance of the enemy and call for illumination and supporting fires. They withdraw before they become engaged in close combat.

c. Illumination is used extensively to expose the enemy as he approaches the forward platoon areas. It is the responsibility of the company commander to inform units on his immediate right and left of the intent to use illumination or the possibility of its use when such usage will hamper the operations of other units. If infrared viewing devices are available, the area may be illuminated with only infrared light. As a general rule, weapons are not fired until targets are visible. When surprise is desired, fires are opened only on the order of leaders. All leaders maintain rigid

fire control to prevent indiscriminate firing which only results in needless expenditure of ammunition and disclosure of positions. Leaders may direct some weapons to fire at flashes and, in some instances, at sounds. Crew-served weapons fire using predetermined firing data or stakes and by using artificial illumination. Trip flares and field expedients such as fougasse can be used to provide illumination.

d. When the enemy starts his assault, the platoon leader calls for final protective fires in the threatened area. His automatic riflemen and riflemen fire within their sectors except as otherwise directed by their fire team leaders. Stakes, set up during daylight, assist them in covering their assigned sectors. They use hand grenades and mines to supplement other fires as the enemy gets close to the position.

e. Other aspects of the conduct of the defense at night are generally the same as for the conduct during daylight.

143. Counterattack

a. If the enemy penetrates the forward positions and seizes or threatens key terrain, all available fires are delivered in an attempt to destroy or eject him. If this fails, the company commander must decide whether to try to block further penetration with his reserve or to counterattack. Normally, he does not attempt a counterattack unless the enemy has been stopped and is not being reinforced. To counterattack, his maneuvering force with its available fire support must be strong enough to destroy the enemy and restore the penetrated area. The company commander can rarely constitute so strong a counterattacking force. When an enemy force is strong enough to penetrate his forward positions, he usually has to retain all of his reserve to block it.

b. If the company counterattacks, the entire reserve with attached tanks not otherwise engaged is normally the maneuver force. All available fires are used to support the counterattack. The commander implements the appropriate counterattack plan, modifying it with fragmentary orders as necessary to meet the existing situation. The maneuver force, avoiding friendly positions, makes a quick, decisive assault and mops up the penetrated area. Following the counterattack, the company commander may order all or part of the reserve to occupy and defend the area regained, or he may order it to return to positions in rear and have a forward platoon reoccupy the area.

c. When the company commander decides to commit his reserve in a counterattack, he notifies the battalion commander immediately. He designates a temporary reserve from available personnel such as personnel of company headquarters and drivers. He

may order the temporary reserve to occupy a prepared reserve platoon blocking position.

Section V. PERIMETER DEFENSE

144. General

In a perimeter defense, the company is physically disposed to meet an attack from all directions at once. The company may have to adopt this defense when it is separated from the remainder of the battalion either by enemy action or by its assigned mission.

145. Organization of the Defense

a. A perimeter defense established by a rifle company consists of a perimeter and a reserve area (fig. 26). Each of the platoons on the perimeter is assigned a portion to organize and defend. The reserve may consist of a portion of a rifle platoon plus elements of the weapons platoon and company headquarters acting as riflemen. If all elements of all three rifle platoons are needed on the perimeter, the reserve may consist only of elements of company headquarters.

b. The frontages of the company and platoons on the perimeter are generally the same as described for the defense in paragraphs 126 and 136, except that the company front is circular rather than linear. The company commander assigns platoon frontages based on the criticality of approaches, and the observation and fields of fire available. Platoons with the most dangerous approaches are assigned narrower frontages. Gaps between platoons are covered by fire and observation. In close terrain, gaps on the perimeter are generally reduced. Gaps may have to be occupied at night to prevent infiltration. For defense in an objective area of an airborne operation, see chapter 6.

c. Security is provided as described in paragraphs 127 and 136.

d. The employment of organic and attached weapons in the perimeter defense is as described in paragraphs 129, 132, 136, and 138.

e. Machineguns are usually employed singly to provide adequate coverage of all dangerous approaches.

f. The 81-mm mortar section is usually located in the reserve area.

g. Fires may be available to the company from fire support units outside the perimeter. These fires are utilized as described in paragraph 132.

h. The company commander closely supervises the use of weapons on the perimeter to insure that gaps are adequately covered by fire and that maximum mutual support is achieved.

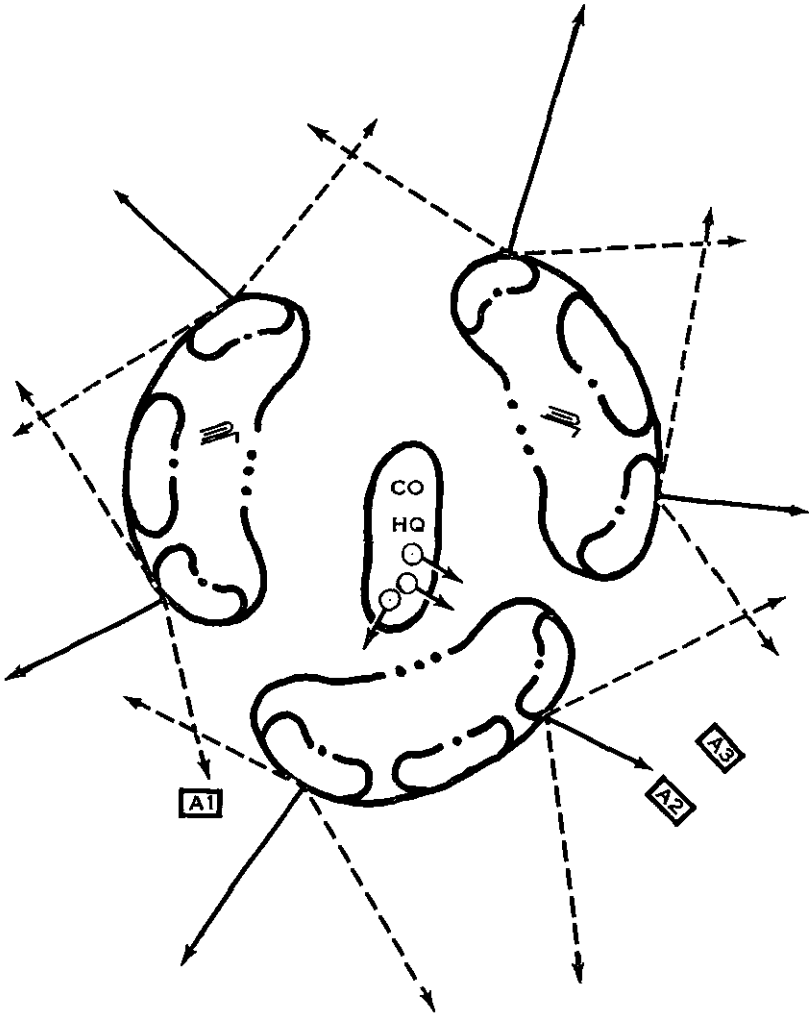

NOTE:

ENEMY IN ANY OR ALL DIRECTIONS
NOT TO SCALE.

Figure 26. Company in a perimeter defense.

146. Conduct

a. The conduct of the perimeter defense is generally the same as described in paragraphs 140 through 143.

b. If the enemy succeeds in penetrating the perimeter, the company normally counterattacks. All available troops not actively engaged are used to destroy or eject the enemy and to restore the lost portion of the perimeter.

c. Resupply is usually accomplished by air. Helicopters are normally used to evacuate casualties.

d. Patrols are used to maintain contact with the enemy. The company is alert for any withdrawal of the enemy force. Should such a substantiated withdrawal occur, the company must be prepared for immediate redeployment consistent with its implied or stated missions, on order of the battalion commander.

Section VI. REVERSE SLOPE DEFENSE

147. General

a. *Use.* A reverse slope defense is one organized on the portion of a terrain feature that is masked by a crest from enemy direct fire and ground observation from the front. All or any part of the forces on the FEBA may be on the reverse slope, depending on the terrain in the area to be defended. A successful reverse slope defense depends on control of the crest either by fire or physical occupation. The battalion commander may direct the occupation of a reverse slope position under the following conditions:

- (1) When the forward slope is untenable because of enemy fire.
- (2) When the forward slope has been lost or not yet gained.
- (3) When the terrain on the reverse slope gives better fields of fire than the forward slope.
- (4) To avoid a dangerous salient or reentrant.
- (5) When possession of the forward slope is not essential for observation.
- (6) To assist in achieving deception and surprise.

b. *Advantages and Disadvantages.* In a reverse slope defense, the forward elements of the battle area are protected from enemy ground observation and direct fire weapons. Enemy indirect fire weapons normally must deliver unobserved fires, which reduces their effectiveness. When the enemy has been deceived as to the true defense situation, he may advance to close contact before he realizes he has discovered the battle area, then it is too late for him to deliver nuclear fires without endangering his own forces. The defender may effectively employ deceptive measures such as dummy positions on the forward slope. These advantages permit greater freedom of movement, more detailed improvement of the position, ease of supply, and rest for the troops. Two major disadvantages are the difficulty of maintaining observation of the enemy and the restricted range for direct fire weapons. Without observation, the effectiveness of friendly direct and indirect fires is limited. Obstacles and minefields on the forward slope cannot be covered by direct fire weapons. If the enemy seizes the crest, he can have the advantage of attacking the battle area moving downhill while a counterattack to eject him must move uphill.

148. Organization of the Defense

a. *Disposition of Troops* (fig. 27). The reverse slope is generally organized according to the fundamentals of defense (par. 118). Special considerations include the following:

- (1) Observation and security (O&S) groups are established on or just forward of the topographical crest to give observation over the unit's entire front. These groups may vary in size from two men to a rifle squad (usually from the reserve platoon). They may be reinforced with machineguns, antitank weapons, and tanks. At night, these groups are strengthened to prevent infiltration and surprise. If the company is part of the battalion in a reverse slope defense, the O&S groups may be controlled by the battalion commander.
- (2) The forward platoons are located within effective small arms range of the crest. Troops on the reverse slope are located to permit maximum fire on the crest, the approaches around the crest, and on the forward slope of adjacent terrain features. A desirable location for the reserve platoon is the military crest of the next high ground to the rear, if it is within supporting range.

b. *Fire Support*. The employment of organic and attached weapons and supporting fires are generally as discussed in paragraphs 129, 132, and 138.

- (1) Machineguns and other automatic weapons are placed where they can deliver the most effective surprise fire on the enemy as he crosses the crest. Their sectors of fire should provide maximum coverage between the FEBA and the crest. Machinegun final protective lines are designated as in the forward slope defense.
- (2) In the reverse slope defense, antitank squads may be positioned in the reverse platoon area (a(2) above) to better advantage than when defending the forward slope. Firing positions on the next high ground back of the forward platoons often give better fields of fire than positions in the forward area.
- (3) The reserve platoon can often provide more effective fire support for forward platoons than in the defense of the forward slope.
- (4) Barrages are normally placed along the crest of the hill to deny it to the enemy (par. 132). When the FEBA is as much as 500 meters back of the crest, it may be more advisable to locate the barrages closer to the FEBA than to the crest. In this case, concentrations are planned

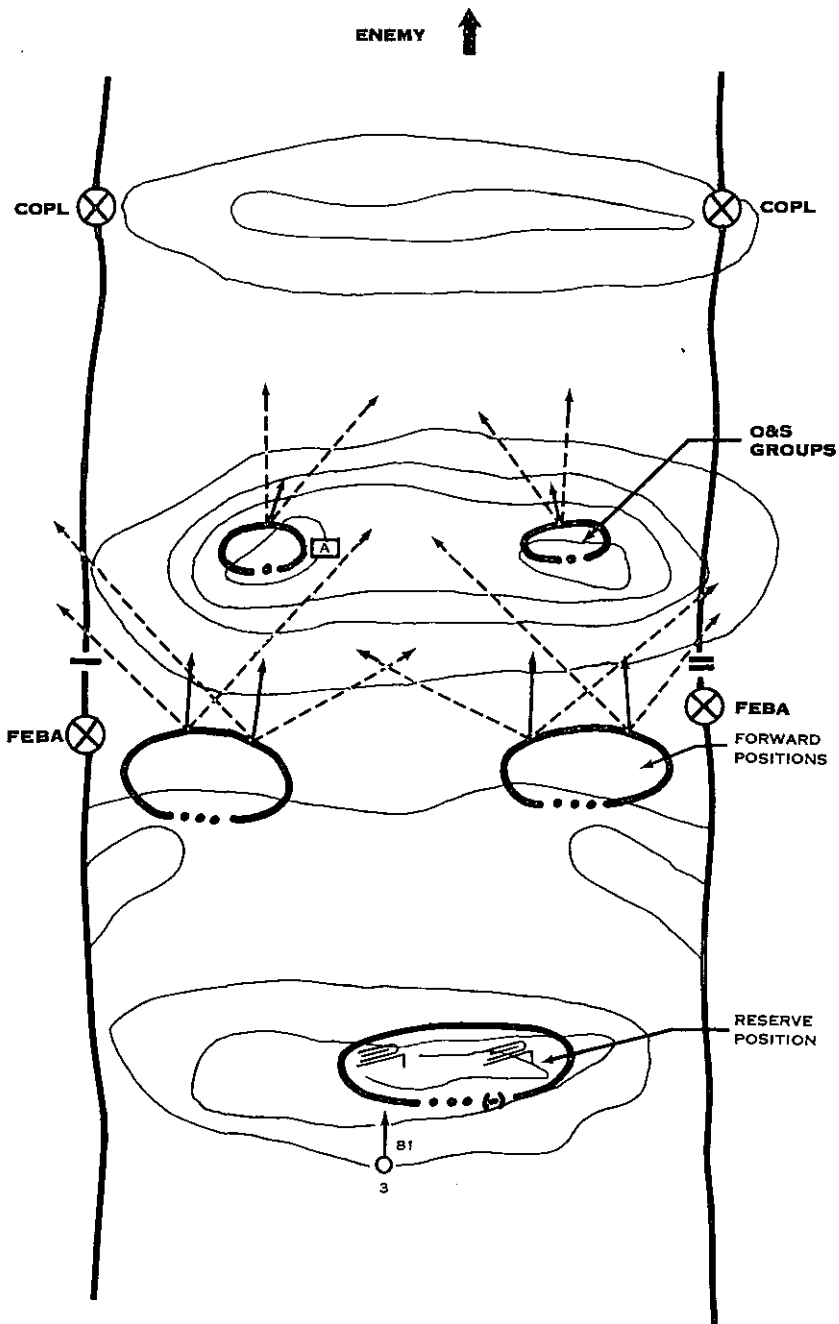

Figure 27. Rifle company in a reverse slope defense (schematic).

both on and short of the crest to keep the enemy under fire as he advances toward the planned barrage area.

149. Conduct

The conduct of a reverse slope defense generally parallels that of a forward slope defense. The O&S groups give warning of an enemy approach and delay and disorganize him with long-range fires. To give a better coverage of the front during periods of poor visibility, warning and illuminating devices such as flares, searchlights, infrared equipment, and antipersonnel mines are used extensively. As the enemy forces the O&S groups to withdraw, prearranged concentrations are delivered on the forward slope to disrupt the enemy's attempts to mass for an assault. Automatic weapons with the O&S groups are withdrawn first so they can occupy their primary firing positions before the enemy reaches the crest. Direct fire weapons within the battle area withhold their fires until suitable targets appear. As the enemy crosses the crest, barrages (or concentrations) are fired. All other indirect fire weapons capable of doing so, fire concentrations in support of the threatened area. If the enemy makes a penetration, the counter-attacking force destroys or ejects him and reestablishes the O&S groups on the crest.

Section VII. DEFENSE OF A RIVER LINE

150. General

a. The fundamentals of the defense of a river line are the same as for other defenses (par. 118).

b. The battalion order may require the company to defend on or close to the near bank or, if that terrain is not adaptable, on terrain farther to the rear which controls approaches from the river. When the FEBA is near the river, the COPL is located on the far side. When the FEBA is farther to the rear, the COPL may be either on the near or far side of the river, depending on the terrain.

c. The advantages afforded by a river obstacle are exploited to the maximum, but leaders and troops must be careful not to overestimate the value of the river as an obstacle.

d. Defense planners must consider the various means available to the enemy for crossing the river, such as individual flotation devices, boats, amphibious vehicles, and helicopters.

151. Organization of the Defense

a. *Disposition of Troops.* Forward platoon defense areas are selected and organized generally as described in paragraphs 128 and 136. When the FEBA is near the river, the forward platoons

are positioned to cover the most dangerous crossing areas. When the FEBA is farther to the rear, forward platoons are positioned to cover the most dangerous approaches from the river. The company commander retains a reserve whenever possible. He may have to select many supplementary reserve positions to provide depth in areas of a likely enemy crossing and to permit defense against helicopterborne attack.

b. Fire Support. The employment of organic and attached weapons and the use of supporting fires are generally as discussed in paragraphs 129, 132, and 138.

- (1) When the FEBA is near the river the following special considerations apply: machineguns are positioned to cover dangerous crossing sites and avenues of approach to them; the terrain along a river usually offers excellent fields of fire and permits grazing enfilade fire to be delivered along the front; and final protective lines may be established to graze the river or the far bank.
- (2) Antitank squads and attached tanks are positioned where they can cover likely crossing sites for amphibious vehicles and cover avenues of approach to the river.
- (3) Barrages are normally planned on the far bank at probable crossing sites (par. 132).

c. Security and Surveillance. Security and surveillance are as described in paragraphs 122, 127, and 137, with the following modifications:

- (1) When the combat outpost is located on the far bank, it seldom has tanks attached unless there are bridges or fords which can be kept intact for their withdrawal. Plans for withdrawing the combat outpost include both primary and alternate crossing means. Crossing means available may include helicopters and APC. When the COPL is on the near side of the river, elements of the outpost patrol aggressively on the far bank. The patrols are particularly alert to locate lucrative nuclear targets and to determine where the enemy will attempt to cross.
- (2) When the FEBA is near the river, local security elements are often placed on the far bank where they patrol aggressively. The patrols are particularly alert for any enemy withdrawal which might indicate their intent to use nuclear weapons. Plans for withdrawing the security elements include both primary and alternate crossing means.
- (3) Special consideration is given to providing adequate surveillance of rear areas to detect airborne attack.

d. Use of Armored Personnel Carriers.

- (1) Special consideration is given to attaching APC to the combat outpost, patrols, and other security elements that operate on the far bank, if they are not organic.
- (2) It is normally desirable for the reserve to be mechanized so it can move rapidly to supplementary positions. See paragraphs 129 and 137.

152. Conduct

a. When security elements withdraw to the near side of the river, bridges are blown, fords are mined, and boats and barges are destroyed in accordance with directives.

b. When the FEBA is near the river, the defender attempts to keep the enemy from crossing. The company commander shifts his reserve as necessary to block a possible penetration. If the enemy succeeds in crossing and making a penetration, the company normally contains the penetration until a higher echelon can counterattack (par. 143).

c. If the FEBA is located farther to the rear, the company determines the enemy's principal crossing sites, destroys him by fire, and counterattacks while he is astride the river, or blocks his exit from the landing areas. The destruction of the enemy force including his crossing equipment, rather than the restoration of the FEBA, is the primary consideration.

Section VIII. RIFLE COMPANY IN A RESERVE ROLE

153. Missions and Employment

a. The reserve of a battalion in defense consists generally of one or more rifle companies and all or a portion of a tank company. Normally the battalion reserve maneuver elements will be combined arms teams (infantry-tank). When aircraft are available, a portion of the reserve may be an airmobile force.

b. A reserve rifle company may be assigned one or more of the following tasks:

- (1) Block or canalize an enemy penetration.
- (2) Protect the battalion flanks and rear.
- (3) Act as the maneuver element in a counterattack.
- (4) Perform security and surveillance missions.
- (5) Assist in preparing forward company defense areas.
- (6) Cover the withdrawal of forward companies.
- (7) Relieve a forward company.
- (8) Support the forward companies by fire.

c. The battalion commander designates blocking positions in the battalion rear area. He specifies the priority of construction and designates the positions to be occupied initially.

d. A reserve rifle company may be required to attach elements (normally rifle platoons) to the forward companies for use on the combat outpost.

e. The company may be given the responsibility for providing the entire COP forward of the battalion. This may occur when time for preparing the forward company area is limited, when the COPL is beyond supporting distance of the forward companies, and when a COP is to be established forward of new defensive positions in a night withdrawal (par. 122).

f. The company provides security of the battalion rear areas as directed by the battalion commander. The battalion rear area is the area inclosed by the flank boundaries, a line generally parallel to the front running through the rear of the forward company boundaries, and a line generally parallel to the front running through the rear of the battalion flank boundaries. The rear area security mission normally requires the reserve company to provide protection against attack by airborne forces, guerrillas, and infiltrators in the rear area (par. 124). Rear area security measures may include the use of observation, sentinel, and listening posts; foot, motorized, and airmobile patrols; roadblocks; and warning and surveillance devices (pars. 127 and 137).

154. Organization of Positions

a. Reserve positions are organized generally the same as in a forward company area (pars. 135–139).

b. The 81-mm mortar section may be directed to reinforce the fires of the mortars of a forward company (par. 129). In this case, barrages are planned and fired as requested by the reinforced unit. When no reinforcing mission is assigned, the mortars of a reserve company do not fire barrages. They may be assigned concentrations to fire, subject to the battalion commander's discretion. Mortars will be prepared to fire within and to the flanks of the battle area.

c. The construction of obstacles is coordinated closely with battalion to permit the desired movement of friendly forces in the battalion rear area.

155. Counterattack Planning

a. The battalion commander directs and supervises the preparation of battalion counterattack plans. The battalion reserve is normally the counterattack maneuvering force, though other elements of the battalion are often included. The plans normally attach all friendly forces in the penetrated area to the maneuvering force.

b. Each battalion counterattack plan normally assigns the ma-

neuvering force a line of departure, direction of attack, and objective. An attack position is normally designated but used only when necessary. The company commander prepares a plan for his company to implement each of the battalion plans. Subordinate leaders of the company also prepare their plans. (See also par. 137 and FM 7-20.)

156. Conduct

a. Throughout the conduct of the defense, the reserve company commander keeps informed of the situation and, in turn, informs his subordinates. The entire company must react quickly and effectively to battalion orders. The company commander anticipates the possible commitment of his company and prepares plans accordingly. Reliance is placed on fragmentary orders.

b. The company or its elements may be ordered to move to positions to block or canalize an enemy penetration or to protect the battalion flank(s). Movement is rapid (by vehicle if possible), and over previously reconnoitered routes that give maximum concealment and cover. For conduct of the defense from these positions, see paragraphs 140 through 143.

c. When the company participates in a counterattack, the original plan will normally have to be revised slightly by fragmentary orders to make it applicable to the situation. (For conduct of the counterattack, see pars. 140-143.) The success of the counterattack depends largely on surprise, boldness, and speed of execution. When the enemy has been destroyed or ejected from the penetrated area, the company may be ordered to assume responsibility for that area or to move to positions in the battalion rear. If the counterattack force cannot entirely restore the original battle area, it consolidates the ground gained.

Section IX. RELIEF IN PLACE

157. General

a. Secrecy is essential in preparing for and conducting a relief. Darkness and reduced visibility help to preserve secrecy, so reliefs are made more frequently at night than during daylight. The relief is conducted as rapidly as possible, consistent with secrecy and control.

b. During a relief, units are particularly vulnerable to nuclear and nonnuclear fires. To avoid a concentration of troops, platoons may be relieved one at a time unless a particular situation requires all company elements to be relieved at once.

158. Planning the Relief

Plans are as detailed and complete as time permits and include—

a. Reconnaissance. Preceding the relief, the incoming company commander and platoon leaders conduct a daylight reconnaissance of the defense area, routes, and locations where guides will be met. They familiarize themselves with defensive dispositions and plans, the terrain, and the enemy situation. The outgoing company commander makes necessary plans for conducting his part of the relief. He usually needs to remain with his unit, so he designates representatives to reconnoiter the outgoing route, guide locations, and the new area to be occupied, as appropriate.

b. Liaison Personnel. The commander of the incoming company and his platoon leaders take liaison personnel forward with them on their reconnaissance and arrange to leave them on the positions to be occupied. The liaison personnel keep informed of all changes occurring after the reconnaissance. When practicable, liaison personnel from the outgoing unit remain on the position long enough to further orient the newly committed unit commanders.

c. Exchange of Crew-Served Weapons, Supplies, and Equipment. Commanders of the incoming and outgoing units arrange for the mutual exchange of crew-served weapons which cannot be easily moved or whose removal would disrupt the effective delivery of fires. The exchange is based upon the authority included in the relief order of the next higher commander. Outgoing units normally leave excess ammunition, field fortification material, wire lines and switchboards, range cards, and minefield records on position. Radios and radars are not usually exchanged.

d. Attachments. To simplify control and reduce the number of guides, the incoming rifle company commander normally attaches weapons crews to the rifle platoons in whose area they will operate. The outgoing rifle company commander also normally does the same. Both incoming and outgoing rifle platoon leaders normally attach weapons crews to the rifle squads in whose area they are to operate. Attachments during the relief are generally made for the movement only.

e. Guides. The guides should reconnoiter and mark relief routes in advance. The incoming and outgoing companies should use different routes to facilitate control and dispersion. The activities of the guides should be supervised to insure efficiency and avoid unnecessary delays. An incoming company is usually guided by its own personnel to the rear of the battle area of the outgoing company. From this point forward it is guided by personnel of the outgoing company. There should be no break in the movement when changing guides or at any other time. Personnel of the out-

going company guide their unit during the complete movement to the rear.

f. Periodic Reports. All commanders provide for periodic progress reports to be made during the conduct of the relief.

g. Security. Normal activities are simulated as much as practicable. Local security elements are normally maintained by the outgoing unit and are usually the last elements of that unit to be relieved. The relief is not mentioned in the clear over electrical means of communication. The size and activities of reconnaissance parties are limited and the movement of vehicles is restricted. Light and noise discipline is enforced.

h. Relief Order. The relief order, which follows the standard operation order sequence, includes such specific items as the times for the relief to begin and end; the time or condition for exchanging responsibility for the battle area; routes; attachments; march formations; the designation and location of crew-served weapons, equipment, and supplies; security measures; action to be taken in the event of hostile action during the relief; and the requirement for periodic reports to be submitted by subordinate leaders during the conduct of the relief.

159. Conduct

a. General. See paragraph 157.

b. Incoming Company. At the time prescribed for the start of the relief, the incoming company moves forward to the company release point, where it is released to the control of the company commander. Without delay, the company moves to the platoon release point. Guides lead the platoons from the platoon release point to the squad release points, where other guides lead the squads to their positions. The incoming and outgoing squad leaders then relieve a few men at a time until the relief is completed. Enough time is allowed for each man of the incoming squad to be thoroughly oriented by the man he is relieving.

c. Outgoing Company. As each squad (with attachments, if any) is relieved and the squad leader has been relieved of responsibility for the position, the squad moves directly from its assembly area to the platoon assembly area. When the platoon leader is relieved of the responsibility for his defense area, he joins his platoon in the assembly area and moves it to the company assembly area without further delay. When the company commander is relieved of responsibility for the company area, he rejoins his company. Throughout the conduct of the relief, commanders at all levels are responsible for the dispersion and security of their units. When time permits, the relief of self-propelled weapons should be phased so as to minimize noise and avoid a betraying movement.

160. Command During the Relief

a. Commanders at each echelon should be together at the command post or observation post of the outgoing unit to facilitate control and communication.

b. The execution of a relief takes place under the direction of the commander of the outgoing unit. He usually remains responsible for the defense of the area until the majority of the relieving unit is in position and communication and control have been established by the incoming commander. The exchange of responsibility is agreed upon by the commanders concerned and verified by receiving the concurrence of their next higher commanders. If the enemy attacks before the incoming commander assumes responsibility for the defense, he assists the outgoing commander with all means available to him. In this event, the elements of the incoming company already in the area are attached to the outgoing company for the conduct of the defense.

CHAPTER 5

RETROGRADE OPERATIONS

Section I. GENERAL

161. Introduction

a. Every retrograde movement made from hostile contacts starts with a withdrawal.

b. The battalion commander must give his approval before the company or its elements may start a retrograde operation.

c. The movement may be by foot, ground vehicle, aircraft, or a combination of these means.

d. The rifle company normally participates in a retrograde operation as part of a larger force (FM 7-20).

162. Purpose

Retrograde movements are conducted for one or more of the following purposes:

a. Harass, exhaust, and inflict punishment on the enemy.

b. Draw the enemy into an unfavorable situation.

c. Permit the use of elements of a force elsewhere.

d. Avoid combat under undesirable conditions.

e. Gain time without fighting a decisive engagement.

f. Disengage from combat.

g. Place the forces involved in a desired position in relation to other friendly forces.

h. Avoid destruction by a superior enemy force.

163. Types

A retrograde operation is any movement of a command to the rear or away from the enemy. It may be forced by the enemy or made voluntarily. It may be classified as a *withdrawal*, a *delaying action*, or a *retirement*.

164. Basic Considerations

a. Commanders must strive to keep the morale of the troops high. Troops should be informed that the action is part of a sound plan with a specific purpose. False rumors and exaggerated reports of enemy capabilities are counteracted by keeping the men informed. Forceful leadership, strict discipline, control, and prior planning are required to keep morale from deteriorating. The presence of leaders and commanders at critical points helps to bolster the confidence of the troops.

b. Terrain is exploited to the maximum. Good observation and fields of fire are sought to permit engaging the enemy at long ranges. Maximum use is made of concealment and cover. Natural obstacles are supplemented with minefields, toxic chemical agents, atomic demolition munitions, and other artificial obstacles to strengthen defenses, protect exposed flanks, and delay the enemy. Emphasis is placed on denying avenues of approach and key terrain features to the enemy. Efforts are made to canalize the enemy and to force him to mass so he can be destroyed by fires.

c. Demolitions and obstacles are employed to the maximum extent practicable in order to delay and disorganize the enemy advance. In planning use of demolitions, guidance must be provided on the time or conditions under which demolitions will be fired. A demolition firing party should be designated and, when appropriate, guards should be provided to prevent premature firing or seizure by enemy infiltrators. Care must be exercised to insure that demolitions do not hamper future operations in the area. For detailed information concerning the destruction of bridges see FM 7-20.

d. Because retrograde operations are usually more difficult to control than other operations, plans and orders are made in greater detail. The responsibility for executing the plans is often decentralized. As the course of action cannot be predicted with accuracy, plans should be flexible. Alternate plans are prepared as time permits. Leaders at all echelons must be thoroughly familiar with the concept of the operations, so they can make sound decisions if they lose contact with higher commanders. Retention of the initiative is important. Close combat is avoided unless required to accomplish the mission.

e. Ground and air transportation is used, when possible, to move units rapidly. Detachments left in contact and covering forces normally have transportation priority. Special measures are needed to control traffic at critical points.

f. The enemy may be expected to follow up any retrograde movement relentlessly and to strike a withdrawing force from any direction. For security, the withdrawing force moves rapidly under the protection of mobile security forces, reconnoiters continuously to establish and maintain contact with the enemy, sets up antitank and air defense, and takes measures to counter enemy airborne landings.

g. Plans are made to insure that civilian refugees do not hinder the operation by blocking withdrawal routes. Higher headquarters helps plan for the handling of refugees.

h. Detailed plans are made in advance to insure adequate supplies and equipment at each successive position. The level of sup-

ply should not be greater than the anticipated need. Material should not be allowed to fall into enemy hands; that which cannot be evacuated is destroyed.

i. Every effort is made to prevent wounded men from being captured. Aircraft can be used to speed their evacuation and release ground transportation for other purposes. In an emergency any type vehicle can be used as an ambulance and any personnel can be used as litter bearers in order to insure the safe evacuation of all casualties.

j. Close cooperation and coordination are required when a withdrawing force passes through a friendly unit. Plans include measures for mutual recognition, routes to be used, points of passage, responsibility for zone, and priority of routes in rear. The withdrawing unit passes through as quickly as possible to reduce the period of concentration. The withdrawing unit commander is responsible for notifying the unit in position when the last withdrawing element has passed.

165. Withdrawal: General

a. A withdrawal is an operation by which all or part of a deployed force disengages from the enemy so it can initiate some other action. The new action may be a retirement, a delaying action, or a defense from another position.

b. A withdrawal may be conducted during daylight or at night.

c. Preferably, a withdrawal is made voluntarily and, to deceive the enemy, with as much secrecy as possible. Deception is easiest at night or under other conditions of reduced visibility. For this reason, the technique involved when the withdrawal is based on deception is referred to as the *night withdrawal*. The night withdrawal technique may be used during daylight hours in smoke or haze, or during inclement weather which limits visibility, and in the absence of definite enemy pressure.

d. When a unit is forced to withdraw and has no chance of doing so secretly, it must disengage by fighting the enemy until it can gain freedom of action. Such a withdrawal, made under pressure and without deception is referred to as a *daylight withdrawal*—even when it is made at night.

e. Complete and detailed plans are made for a withdrawal. They include—

(1) The time and priority for the withdrawal of forward units (H-hour).

(2) Control measures.

(a) Routes and/or zones.

(b) Assembly areas.

- (c) Covering positions.
- (d) Rallying points.
- (3) Weapons attachments.
- (4) Complete reconnaissance.
- (5) The composition of the forces to be left behind the main body (mission, size, disposition, and weapons with the covering force or the detachments left in contact).
- (6) Administrative details.
- (7) Security measures.
- (8) The mission to be performed in the new area.

f. As soon as the company commander receives a warning order for a withdrawal, he and his subordinate leaders, in turn, issue their warning orders. When possible, orders are transmitted personally by the company commander or his representative to avoid assembling the leaders of units in contact. Withdrawal orders are not transmitted by electronic means except in extreme emergencies.

g. Leaders reconnoiter the new positions and the routes to them as thoroughly as time permits. Enemy action may make it advisable for the leaders of units in contact to remain with their units and appoint representatives to conduct this reconnaissance.

h. For employment of surveillance section, see appendix IV.

166. Retirement

a. A retirement is an operation in which a force withdraws without enemy pressure. When a withdrawal from action precedes a retirement, the retirement begins after the main forces have broken contact and the march columns have been formed.

b. A rifle company normally participates in a retirement as a part of a larger force. It receives specific orders as to the mission, time and type of movement, routes, and march objectives. The company may provide part of the security for the main body (rear, flank, or advance guards), or it may march as part of the main body. For a discussion of the actions of the company during movement, see chapter 7.

167. Stay-Behind Forces

a. Stay-behind forces may be established as a result of all or part of a unit being cut off by enemy action or as a directed action by higher headquarters to accomplish a specific mission.

b. When a unit is ordered to act as a stay-behind force, plans for its activities are prepared in detail before the operation. They include plans for resupply and withdrawal. Appropriate missions for a stay-behind force include calling for and adjusting fires; locating targets; reporting enemy information; and destroying key

installations such as enemy communication facilities, supply installations, command installations of large units, and nuclear delivery means. The force normally occupies a concealed area until the enemy attack echelon has passed. It avoids detection by the enemy, consistent with the accomplishment of its mission. It conducts offensive actions generally as described for raids (pars. 106-108). Helicopters may frequently be used to withdraw stay-behind forces.

c. Forces that are cut off by enemy action can accomplish many of the missions described in *b* above.

- (1) When a unit is cut off, its commander uses all means to notify his next higher commander of the situation and ask for instructions. If the higher commander orders the unit to destroy enemy rear installations, attack enemy forces from the rear, or otherwise disrupt the enemy attack, it acts as discussed in *b* above. The higher commander may order the unit to fight its way through enemy lines to rejoin friendly forces. If so, the two commanders coordinate the action closely. The higher unit may assist the breakthrough with supporting fires and a limited objective counterattack.
- (2) If the cutoff unit is out of communication with its parent unit, the commander decides what action to take based on his knowledge of the situation and the concept for the operation. He considers his own situation (condition of the men, unit strength and mobility, and his food, ammunition, and fuel supply); enemy strength and mobility; probable location of friendly forces; terrain; and the higher commander's mission. He fights his way through to friendly forces if he has a reasonable chance for success. If he is deep in enemy territory with little chance of rejoining friendly forces with the bulk of his equipment, he may decide to do all the damage he can to the enemy rear area before trying to get through. He retains his force as a unit, evading the enemy except when attacking an installation or an enemy force. He sends out patrols to provide security and information of the enemy and terrain. If his unit is surrounded and his force is adequate, he breaks out of the encirclement. He makes maximum use of captured materiel. The force continues to fight as a unit until it no longer has the capability of fighting. The commander may then divide it into small groups and have them infiltrate through enemy areas. For techniques of evading the enemy while returning to friendly lines, see FM 21-76.

Section II. NIGHT WITHDRAWAL

168. General

a. The success of a night withdrawal depends primarily on secrecy and deception. Troops and weapons withdraw and assemble as quietly as possible. Detachments left in contact protect and conceal the withdrawal of the main body. They simulate the normal activities of the unit by their fires, patrolling, and other deceptive means. In preparation for a night withdrawal, the battalion commander may prescribe special tactical measures to confuse and disrupt the enemy, such as limited objective attacks and raids.

b. The battalion order prescribes the time of withdrawal; general strength and composition of the detachments left in contact; company assembly areas, routes of withdrawal, route priorities, and any additional control measures required; action to be taken in case of hostile attack; attachment of supporting units to the company for the withdrawal; and instructions pertaining to the withdrawal of the detachments left in contact. The order also covers the organization of the new position to the rear, if appropriate.

169. Planning

a. When the company commander receives the battalion order, he issues a warning order immediately and starts his planning. He makes maximum use of available daylight for reconnaissance. All leaders, including squad leaders, reconnoiter routes to the rear and the new positions as thoroughly as available time and the enemy situation permit (par. 165). The battalion commander may prescribe restrictions on the size and movement of reconnaissance parties. Activities in preparation for the withdrawal must not compromise secrecy.

b. Frequently, the leaders of the company cannot reconnoiter the new position personally (par. 165). Since the company executive officer will be employed to command the detachments left in contact, the company commander normally directs the weapons platoon leader to command a reconnaissance detail for the new area. This detail should consist of at least one representative from each rifle platoon (normally the platoon sergeant) and may include others, such as communication personnel. Based on guidance from the company commander, the weapons platoon leader selects platoon defense areas and weapons positions, and makes appropriate plans for the commander pertaining to the organization of the new position. The rifle platoon representatives prepare plans for the organization of their new platoon defense areas. For simplicity, the disposition of units in the new position is normally the same as

in the old position. When time permits, the reconnaissance detail installs wire lines in the new position. Frequently, the detail does not return to the company, but remains in the new area.

c. The company commander may designate platoon assembly areas for the withdrawal and platoon routes to the company assembly area. If he does not need to maintain close control over the platoon movements he may have the platoon leaders select the areas and routes. Platoon assembly areas are normally immediately in rear of each platoon position. The company commander designates a portion of the company assembly area for each platoon. He specifies measures to be taken to secure the company assembly area.

d. The platoon leader will designate squad assembly areas and routes to the platoon assembly area. A squad assembly area is normally immediately in rear of the squad position.

e. Routes and assembly areas are marked for ease of identification at night, if it can be done without compromising secrecy. Plans are made for the use of guides.

f. To facilitate control during the withdrawal, supporting weapons are normally attached to the rifle platoons in whose areas they are located. Platoon leaders may further attach them to the rifle squads. These attachments are normally effective only for the withdrawal.

170. Detachment Left in Contact

a. The detachments left in contact protect the withdrawal of the main body by deception and resistance. The strength of the detachments usually does not exceed one-third of the company's rifle strength, plus about one-half of the supporting weapons. Normally one rifle squad is left in each platoon area of the forward rifle company. As a platoon withdraws, the men left in place move as necessary to cover the most dangerous enemy approaches into the platoon area and at the same time furnish close protection for supporting weapons. The squad from the reserve platoon may patrol the company rear area or block a dangerous approach into the flank or rear. The detachments left in contact use night surveillance devices to help detect any enemy action that might hinder the withdrawal.

b. The crew-served weapons remaining in the area of the forward rifle company are attached to the detachments left in contact for their protection and the protection of the withdrawing main body, and to provide normal fire patterns to deceive the enemy. Not more than two of the 81-mm mortars are left to support detachments left in contact.

c. Since tanks and ATGM cannot operate with maximum effectiveness during periods of reduced visibility, they may be withdrawn by infiltration before the main body withdraws. They may remain with the detachments left in contact if there is a definite threat of enemy armor, or if deception would be jeopardized by moving them. If ATGM's remain with the detachments left in contact, provisions must be made to provide artificial illumination to permit guidance of the missile by the gunners. All tanks and ATGM left with the detachments left in contact withdraw immediately before or at the same time as other elements of the detachments. Rocket launchers may remain with the detachments left in contact for close-in antitank protection.

d. Usually, the company executive officer commands the company detachments left in contact. A rifle squad leader commands the platoon detachments.

e. A reserve rifle company normally does not leave detachments in contact. The reconnaissance platoon usually provides rear area security for the battalion, but a platoon of a reserve company may be assigned this mission. A reserve company normally establishes the combat outpost for the battalion's new defensive area.

171. Employment of Armored Personnel Carriers

When the mechanized rifle company (infantry and airborne infantry when APC are attached) makes a night withdrawal, APC may be withdrawn using one of the three techniques outlined below.

a. APC's except those provided for detachments left in contact may be withdrawn shortly after dark a few at a time to company assembly areas. Artillery and mortar fires are used to cover the noise of movement. This technique may be used when routes to the rear are limited and when early movement of APC's can be made without compromising secrecy.

b. All APC's may remain initially in their forward positions. The main body moves on foot to the rear to a predesignated assembly area (s) or along a route(s) where they may later be picked up by APC's remaining on position. Immediately prior to the withdrawal of the detachments left in contact, APC's for the main body begin their movement to the rear where they pick up designated elements of the main body. (It is essential that plans provide for loading of dismounted elements on specifically designated APC's. This will facilitate loading and insure retention of tactical integrity during the remainder of the move and on the next position.) Until these APC's on the initial position (usually each with 2 or 3 men) begin their withdrawal, they may add additional firepower to the detachments left in contact. This technique is appropriate

when multiple routes to the rear will enable a quick and orderly withdrawal of all APC's and when there is danger of compromising the secrecy of the withdrawal by earlier movement.

c. All forces on position may withdraw simultaneously without using detachments left in contact.

172. Conduct of the Night Withdrawal

(fig. 28)

a. The rearward movement of all rifle company elements, less the detachments left in contact begins simultaneously at the designated time. Individuals move to squad assembly areas, squads move to platoon assembly areas, and platoons move to the company assembly area. Column formations are normally used for ease of control. The movement is made quietly and rapidly. Consistent with the battalion traffic control plan and the reconnaissance made by platoon leaders, each platoon may be sent immediately to the rear as it arrives at the company assembly area. Sometimes, the

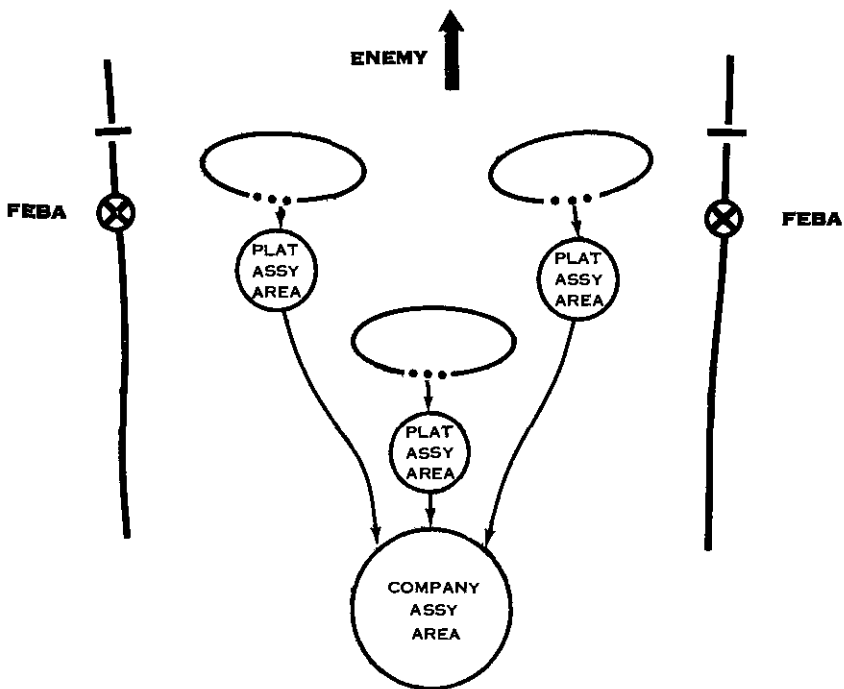

ELEMENTS OF THE COMPANY SPECIFIED BY HIGHER HQ REMAIN AS DETACHMENTS LEFT IN CONTACT. THEY WITHDRAW IN A SIMILAR MANNER IF NOT UNDER PRESSURE; IF UNDER PRESSURE THEY WITHDRAW AS SHOWN IN FIG. 29

Figure 28. Night withdrawal (schematic).

entire main body of the company may be assembled before any element is sent to the rear, although such halts are avoided if possible. Every effort is made to maintain continuous movement. Transportation meets the company as far forward as practicable. The battalion commander prescribes the limit for its forward movement. Vehicles move singly or in small groups, using blackout or infrared lights.

b. The detachments left in contact provide the primary security for the company's withdrawal. The company commander provides additional close-in security with small detachments to the front and rear of the main body and elements to block routes into the flank. The main body normally maintains radio listening silence. It may use wire lines along the route for communication with the battalion commander.

c. Subsequent to the initiation of the withdrawal, and at the discretion of the company commander, the commander of the detachments left in contact (normally the executive officer) assumes responsibility for the area. Squads in each forward platoon area move as planned to cover dangerous approaches and protect crew-served weapons. Existing wire lines are used for control. Enough radios are left with the detachments left in contact to communicate with battalion and to simulate normal traffic on the company nets. All actions of the detachments left in contact are designed to simulate the normal activity of the company.

d. If the detachments left in contact are attacked, they defend to the extent of their capability. They do not withdraw without authority of the commander of the battalion detachments left in contact. If communications are lost, the commander acts in accordance with preplanned instructions covering this possibility.

e. At the specified time or on order, the detachments left in contact withdraw simultaneously. Squads normally move directly to the company assembly area where all are assembled. Before withdrawing, the detachments spoil wire lines by removing sections of the wire. The company detachments left in contact designate small groups to provide security for the movement from the assembly area to the rear. The reconnaissance platoon often screens the movement and maintains contact with the enemy.

Section III. DAYLIGHT WITHDRAWAL

173. General

a. A daylight withdrawal is generally undesirable but, may be forced by enemy action. It is usually characterized by the forward elements fighting as they withdraw, with units in rear covering their withdrawal and assisting them in breaking contact.

b. This type action is enhanced by mechanization of the company.

c. The successful execution of a daylight withdrawal depends to a large extent on effective planning, control, speed of movement, proper use of available firepower, and strong leadership.

d. Often the battalion order for a daylight withdrawal is fragmentary. It normally prescribes the positioning of the battalion covering force; the company zone and/or route(s) of withdrawal, assembly area (if used), and other measures to control movement; the attachment of supporting units to the company; the sequence of withdrawal; and instructions for occupying delaying or defensive positions to the rear. The time of withdrawal may or may not be announced initially.

174. Planning

a. Planning is as detailed as time permits. It is desirable for all leaders to reconnoiter withdrawal routes, zones, and subsequent positions, but time will normally permit only limited reconnaissance. Reconnaissance parties may be used to reconnoiter successive positions. The company commander issues a fragmentary warning order as soon as possible so his subordinates can plan concurrently. Fragmentary orders are issued as plans are formulated. The company commander—

- (1) Assigns each forward platoon a zone and general route of withdrawal so he can coordinate and control their movement. He may also designate checkpoints. The zones of withdrawal extend as far to the rear as it is anticipated the platoons will move while deployed. Usually this is no farther than the location of the company covering force (company reserve), but may be farther for those platoons whose withdrawal cannot be covered by this force.
- (2) Normally prescribes a platoon assembly area for each forward platoon. The assembly areas are normally located in defilade to the rear of the company covering force. When the withdrawal of a forward platoon cannot be covered by the company covering force, it may be necessary to locate the assembly area for that platoon to the rear of the battalion covering force. The assembly area for the company covering force is normally in the company assembly area.
- (3) Designates routes from the platoon assembly areas to the company assembly area or subsequent position, as appropriate. The routes should pass around the flanks to the rear and should offer as much concealment and cover as

possible, consistent with the speed of the movement and the battalion traffic control plan.

- (4) Normally designates the reserve platoon as the company covering force. The covering force may have to be split so that elements can be located where they can cover the withdrawal of all forward platoons. This increases the problem of control. When the battalion covering force is too far to the rear or flank to cover the withdrawal of the company covering force, the company commander may have the rifle platoon(s) occupy successive covering positions.
- (5) Normally attaches organic weapons to the platoons in whose areas they are located. Tanks usually join the company covering force as the forward platoons pass, and, upon passing through the battalion covering force, may be detached from the company and attached to this covering force.

b. Based on the company plan, platoon leaders select routes of withdrawal to their platoon assembly areas. They determine the probable order of withdrawal of elements of their platoons and they may select tentative rallying points along the route of withdrawal. They may relocate crew-served weapons near the topographical crest to obtain better fields of fire. If a platoon must cover its own withdrawal initially, the platoon leader selects one or more subsequent positions to be occupied by the first elements to withdraw.

175. Employment of Armored Personnel Carriers

a. In the mechanized rifle company all elements of the company are mechanized. In some cases APC may be attached to the other types of rifle companies. If the company commander has only enough APC to mount a part of the company, he must decide how he can use them most effectively. He may attach enough to each platoon to mount the last elements of the platoon to withdraw. He may attach all available APC to the forward platoons initially, then as the forward platoons pass through the covering force, he may attach some of the APC to this force. He should also consider providing APC for attached and organic supporting weapons units.

b. If possible, APC occupy hull defilade positions immediately in rear of the platoon position from which they can support by fire the loading and withdrawal operations. If the APC cannot be placed in hull defilade, they are moved as far forward as possible so personnel can load rapidly.

176. Conduct of the Daylight Withdrawal

(fig. 29)

a. Depending upon the situation, the battalion commander may order all forward companies to withdraw at the same time or he may order the least engaged forward units to withdraw first. Fires and smoke are used. In some situations, a limited objective attack may be made to extricate heavily engaged units. Armed helicopters may be used to disengage some of the forward units.

b. The company withdraws only on order. If elements of the company are heavily engaged, the company commander usually orders the least engaged forward platoons to withdraw first. If enemy pressure is about equal along the front, he may order all forward platoons to withdraw at the same time. The company commander's decision as to whether to withdraw the most heavily or least heavily engaged units first is a difficult one. To withdraw the most heavily engaged units first from the area of greatest enemy pressure may subject the entire command to encirclement and destruction. To withdraw the least heavily engaged units first may result in loss of all or a major part of the most heavily engaged units. The decision must be based on determining which plan best preserves the integrity of the force and which best contributes to the overall accomplishment of the mission.

c. The degree of enemy pressure dictates the manner in which the rifle platoon withdraws to the rear of the covering force. A platoon that is not engaged may withdraw as a unit; under enemy pressure it withdraws by using fire and maneuver. Control of the platoon at all times is essential. The enemy situation dictates which, if any, of the tentative rallying points will be used. The platoon sergeant may withdraw with or ahead of the initial elements of the platoon so he can supervise the reestablishment of control of the platoon elements at the rallying point, or so he can supervise the occupation of a subsequent position. Withdrawing elements pause at the rallying point only long enough to reestablish control.

d. When the platoon withdraws using fire and maneuver, riflemen and certain crew-served weapons normally withdraw first under the protection of automatic weapons and tanks. The position is thinned out gradually. Automatic weapons and tanks are usually withdrawn last after other elements are far enough to the rear to be relatively safe. In close terrain, it may be necessary to withdraw the tanks earlier.

e. Withdrawing units are careful not to mask the fires of covering forces to the rear. Tanks fire on the enemy during their withdrawal; they normally join covering forces as they arrive at cover-

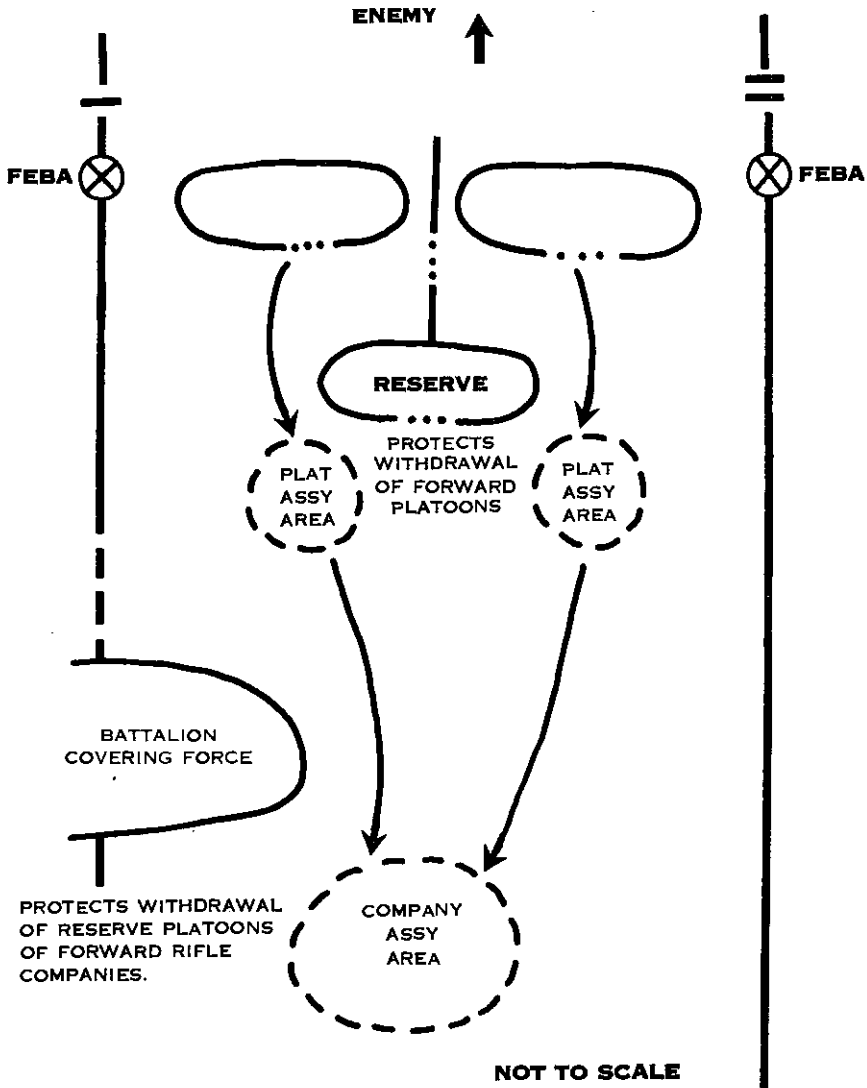

Figure 29. Daylight withdrawal (schematic).

ing force positions. When the company must support its own withdrawal, the 81-mm mortars normally withdraw by echelon so they can furnish continuous fire support. Platoons assemble in platoon assembly areas (if appropriate) and move immediately to the company assembly area, which is usually in rear of the battalion covering force. After the forward platoons withdraw, the company covering force withdraws in a similar manner.

f. Delay in the company assembly area is avoided. Consistent with the battalion traffic control plan, platoons may be sent to the rear individually as they arrive at the company assembly area.

Section IV. DELAYING ACTIONS

177. General

a. A delaying action is an operation in which a unit trades space for time and inflicts maximum casualties on the enemy without becoming decisively engaged in combat. In addition, the operation is aimed at forcing the enemy to mass into a nuclear target. Although the underlying principle of a delaying action is to gain time without fighting a decisive engagement, the company may be forced to accept close combat. A local tactical situation such as limited space and time requirements, may force the company into accepting close combat or a higher commander may order it to improve the overall situation.

b. A delaying force consists of a security echelon, forward forces, and a reserve. A rifle company may occupy the forward area, act as all or part of the security force, or it may be part of the battalion reserve. When extreme frontages are assigned, the battalion reserve may furnish the security echelon.

c. The mission may direct the delaying force to hold the enemy beyond a definite line until a stated time. The reason for the action is normally announced. The delaying force may conduct the operation from a single position or successive positions.

d. During the conduct of the action, the delaying force maintains contact with the enemy. It delays to the maximum between, as well as on, successive positions. It takes advantage of all obstacles and employs maximum fires at long ranges. A mechanized force can conduct a continuous delaying action more effectively than a dismounted force.

178. Desirable Characteristics of Terrain for Delaying Positions

The terrain should offer—

a. Good observation and fields of fire. The delaying force can normally develop long-range fires from positions on topographical crests. If a long delay on one position is required consideration should be given to organizing the terrain to permit mutual support by flat trajectory weapons.

b. Concealed routes of withdrawal.

c. Obstacles to the front and flanks.

d. Maximum concealment for the forces on the delaying position.

e. Cross compartments.

179. Organization of Delaying Positions

a. The battalion commander normally assigns the company an initial delaying position and a zone of withdrawal. The company frontage can be greater than in a defensive situation because (unlike the defense) in the delay, the action is usually for a prescribed

and relatively short period of time. Often, the company commander must use three platoons forward to cover the assigned frontage adequately. He retains a reserve if possible to provide flexibility and depth. The company organizes the extended frontage by accepting larger gaps between platoons, not by increasing the area occupied by platoons over the maximum acceptable for a defense. The company commander covers the gaps between platoons with patrols, fires, observation, surveillance devices, and obstacles.

b. The company commander designates platoon areas as he does for the defense (par. 129), except that the platoon positions are normally on or near the topographical crest to provide long-range fires and observation and to facilitate withdrawal. The company organizes the ground as completely as time permits. It takes advantage of natural obstacles to the front and flanks, and adds to their effectiveness with artificial obstacles.

c. Weapons (such as ATGM) are usually attached to the rifle platoon in whose area they are located. The 81-mm mortars are employed to cover the front and are placed well forward to obtain maximum range. If the mortars cannot adequately cover the front from a central location, they may be attached to rifle platoons as required. The rifle platoon leaders place organic and attached weapons where they can obtain long-range fields of fire.

d. The company commander normally prescribes platoon zones of withdrawal (par. 174). He designates as many subsequent platoon delaying positions as needed for him to control the company's action. The delaying positions should block critical approaches and take advantage of natural and artificial obstacles. He also designates platoon assembly areas and routes of withdrawal, as appropriate. If the assigned frontage allows him to retain a reserve, he uses it as the company covering force. He places it where it can cover the withdrawal of all forward platoons, if possible. Depending on the location of the battalion reserve, the company commander may designate subsequent platoon delaying positions in rear of the company reserve's initial position(s).

e. Platoon leaders select additional delaying positions within their assigned zones. They are generally located so that the first elements of the platoon to withdraw from one position can occupy the next one to the rear to cover the withdrawal of the remainder of the platoon. Consideration is given to locating these positions so that obstacles can be covered by fire.

f. Zones of withdrawal and subsequent positions are reconnoitered as time permits. If possible, the preparation of subsequent positions is started before the delaying action begins. If time is limited, reconnaissance parties prepare plans for the occupation of these positions.

180. Employment of Armored Personnel Carriers

a. APC are used in a delaying action as in a daylight withdrawal (par. 175).

b. When the infantry or airborne infantry rifle company furnishes security elements forward of the delaying position, the company commander normally attaches APC to them. Other security detachments, such as flank security elements, should receive high priority for the attachment of APC. The remaining APC are used as required by the situation and the plan for the conduct of the delay. The company commander may attach some APC to each platoon to mount the last elements of the platoon to withdraw. When it appears that one or two platoons may become more heavily engaged than others, he may mechanize them completely. In some situations, he may be able to shuttle platoons on APC to subsequent delaying positions. In the mechanized infantry rifle company all elements are mechanized.

c. The machinegun on the APC may be used to protect the flanks and add depth to the delaying position, as well as to support the withdrawal from each position and the movement to the rear.

181. Conduct

a. Permission to withdraw forward forces from a battalion delaying position must normally be obtained from the battalion commander. Consequently, the company commander must keep the battalion commander informed of the situation at all times to prevent forward platoons from becoming so heavily engaged that they cannot be withdrawn effectively. If communication with the battalion commander is lost, the company commander decides when to withdraw based primarily on his assigned mission, the concept of the operation, and the enemy situation.

b. The enemy is engaged by fire at long ranges. Every effort is made to stop his leading elements, which forces his following units to mass on roads and trails. If efforts to cause the enemy to mass are successful, all available forces are employed to destroy him. If he cannot be made to mass, he is forced into the time-consuming task of deploying his forces to attack the delaying position.

c. Normally, forward forces withdraw on order, before they become engaged in close combat. The withdrawal is usually conducted like a daylight withdrawal (pars. 173-176). Conditions of visibility may sometimes make it possible to use night withdrawal techniques (pars. 168-172).

d. When the company delays by defending an area for a specified time, the defensive action is conducted as discussed in paragraphs 140 through 143.

e. As the platoons withdraw from initial positions, they continue to delay in their assigned zones. The first platoon elements to withdraw move rapidly to and occupy the next position to the rear, normally under the supervision of the platoon sergeant. These elements cover the withdrawal of the remainder of the platoon. As the last elements withdraw, they set off previously prepared demolitions or prepare other obstacles. All elements of the platoon may join on the first delaying position to the rear, or a part of the platoon may be leapfrogged to the next position to the rear. The platoon leader normally remains with the forward portion of the platoon in such a case. The platoon fights to delay the enemy at each successive position, withdrawing only to avoid close combat. It withdraws in this manner until it passes the covering force of a higher unit. Then the platoon may assemble to continue its movement to the company assembly area of a subsequent position, as appropriate.

f. The company commander coordinates the actions of his withdrawing platoons. Consistent with instructions from the battalion commander, he orders his forward platoons to withdraw in time to prevent them from being cut off by an enemy force advancing rapidly on their flanks. If he has a reserve, he repositions it to block enemy penetrations and protect the flanks and rear. He uses patrols to maintain contact with adjacent units, provide flank security, and block enemy threats from the flanks.

g. If the enemy withdraws from the attack, the company maintains contact and reoccupies the forward positions, if possible. This lessens the likelihood of the enemy placing nuclear fires on the forward forces.

CHAPTER 6

AIRBORNE OPERATIONS

Section I. GENERAL

182. Introduction

a. This chapter covers the tactical employment of the rifle company in airborne operations. The airborne infantry rifle company is the company used as a basis for discussing joint airborne operations. The other types of rifle companies can conduct airlanded joint airborne operations. The infantry rifle company is used as the basis for discussing airmobile operations in paragraphs 207 through 209. The other types of rifle companies can conduct airmobile operations, although the mechanized rifle company must do so minus its heavier equipment.

b. The purpose of considering airmobile operations as a separate section in this chapter is to emphasize its importance and to indicate that airmobile forces may be employed in all types of operations.

c. For a general discussion of airborne operations, see FM 7-20 and FM 57-10.

183. Employment

a. In airborne operations, the rifle company normally fights as part of the battalion, either under direct control of the battalion commander or as a task force or part of a task force within the battalion. However, it is not unusual for the company to act independently or semi-independently during all or part of the operation.

b. The airborne infantry rifle company can enter combat by airlanded or parachute means or a combination of both. The infantry and mechanized infantry rifle companies are limited to airlanded delivery means only.

184. Definitions

a. *Airborne Operation.* An operation involving the movement and delivery by air of combat forces and their logistical support by airlanding or airdrop into an objective area. Airborne operations include joint airborne operations (parachute or airlanded) and airmobile operations (parachute or airlanded).

b. *Joint Airborne Operation.* An operation conducted by Army forces together with forces of another service, usually the Air Force. They may be either strategic or tactical in nature. They

may be either parachute assault or airlanded assault or a combination of the two.

c. Airmobile Operation. An operation in which combat forces and their equipment move about the battlefield in aerial vehicles under the control of a ground force commander to engage in ground combat. One of the primary differences between airmobile operations and joint airborne operations is that in airmobile operations the aerial transport is under the control of the ground force commander. These operations are usually tactical operations limited in mission, range, and duration. Airmobile operations are normally unilateral, but they may be conducted as part of a joint airborne operation.

185. Comparison of Operations

a. The major differences between joint airborne operations and airmobile operations are—

- (1) Type forces required and command structure.
- (2) Command and control of the transport means.
- (3) Characteristics of the aircraft.
- (4) Size and scope of the operation.
- (5) Degree of administrative support and preparation required.

b. While the tactical principles for airborne operations are applicable for both joint airborne and airmobile operations, it should be recognized that airmobile operations can be planned and executed in less time with far greater simplicity.

186. Planning Sequence

Detailed planning for airborne operations is best developed by reverse planning from the objective area in the following sequence:

- a.* Ground tactical plan which includes an assault plan and accompanying fire support plan, a defense plan and accompanying fire support plan, and a linkup plan or withdrawal plan.
- b.* A landing plan, which indicates sequence, time, and place of arrival of troops and material.
- c.* Air movement plan which is based on the landing plan.
- d.* Marshaling plan which is based on the air movement plan.

187. Echelonment for Airborne Operations

a. Combat elements of a force which is to participate in a joint airborne operation are normally organized into three echelons—

- (1) *Assault echelon.* This echelon is composed of those forces required to seize the assault objectives and the initial

objective area and includes the reserve and supporting troops.

- (2) *Followup echelon.* This echelon is that part of the force (less the rear echelon) which is brought into the objective area as soon as practicable after the assault. It consists of additional vehicles and equipment of units in the assault echelon and tactical, tactical support, and service units not required in the assault echelon.
- (3) *Rear echelon.* This echelon is that part of the force which is left in the departure area to perform administrative and service functions not required in the objective area or those units whose functions can be performed more efficiently in the departure area.

b. Combat elements of a force which is to participate in an air-mobile operation are normally organized into two echelons—

- (1) *Assault echelon.* This echelon consists of those forces and their equipment that are airlanded in the objective area to engage in ground combat. It may require one or more lifts, depending on its size and the number and type of aircraft available.
- (2) *Rear echelon.* This echelon consists of the remainder of the force; those not immediately needed in the objective area such as administrative personnel and equipment, and those that cannot be transported in available aircraft. This echelon accompanies the ground linkup force.

188. Rehearsals

All phases of airborne operations should be rehearsed in as much detail as possible. Frequently, terrain similar to that in the objective area can be located for the rehearsal.

Section II. JOINT AIRBORNE OPERATIONS— GENERAL

Note. Wherever the term airborne operation is used in this section, it is construed to mean joint airborne operation unless otherwise indicated.

189. General

This section, and sections III and IV, cover the tactical employment of the airborne infantry rifle company in joint airborne operations. With modifications, the procedures outlined can be applied to the infantry and mechanized infantry rifle companies in airlanded operations.

190. Employment

a. The airborne infantry rifle company can enter combat by parachute or airlanded means or a combination of the two. The infantry and mechanized infantry rifle companies are restricted to airlanded means.

b. The assault landing can be made during daylight or at night. The company can fight immediately upon landing, but it can fight most effectively if it has time to assemble as a tactical unit under control of the company commander. Because of the dispersion of units in parachute operations assembly usually takes longer than in airlanded operations.

c. After an airborne assault landing, the rifle company operates tactically in substantially the same manner as discussed in previous chapters. Following the assault phase, in which initial objectives are seized, the company may defend until linkup with friendly ground forces, until a buildup of forces by aerial delivery permits resumption of the offensive, or until withdrawal. In some situations the company may continue offensive operations and/or special operations immediately after the assault phase, with a subsequent linkup or withdrawal.

191. Preparation for the Airborne Assault

a. Airborne operations require detailed planning at all levels and close coordination with transporting aviation units. The company commander usually participates in the detailed planning of the next higher headquarters, accomplishing concurrent coordination with supporting units at that time. The time available for preparing for an airborne operation may vary from a few hours to several days.

b. The company must maintain the maximum possible readiness to take part in an airborne assault on short notice. The following measures may be taken to maintain readiness, depending on the imminence of an operation:

- (1) Fit personnel parachutes, tag them, and prepare them for movement to loading site (parachute operations only).
- (2) Prepare supplies and equipment for air delivery.
- (3) Issue necessary supplies and special equipment to individuals.
- (4) Maintain up-to-date SOP loading tables that are readily adaptable to probable methods of employment.
- (5) Conduct frequent inspections, checks, and training exercises.

c. For a detailed explanation of loading forms for airborne operations in which Air Force aircraft are used, see TM 57-210. Loading forms are completed to the extent practicable and kept in readiness for a mission. These forms may be included in the unit SOP.

d. A company must be ready to implement plans for marshaling without delay. This requires a detailed company alert plan and marshaling SOP.

192. Orders

a. The company commander usually receives a warning order early in the planning phase so that he can plan and prepare for the operation concurrently with the battalion commander and staff. In addition to information normally included in a warning order for an attack, the warning order for an airborne operation usually includes special security measures, information on the number and types of aircraft allocated to the company, equipment to be delivered with the assault echelon, instructions on preparing equipment for aerial delivery, and any required changes to SOP loading plans. For security, certain information concerning the operation may be withheld until the marshaling phase begins.

b. The battalion operation order is normally issued after units are sealed in marshaling areas. It gives the rifle company its mission and designates the supporting and attached units. When task forces are employed, the battalion operation order specifies their composition and missions. The rifle company's mission for the assault phase is assigned like that for any other attack. In addition, the battalion plans and orders may include—

- (1) The location of drop zones or landing zones for elements of the battalion, as appropriate.
- (2) The plan for reorganization after landing, including the location of company assembly areas, use of assembly aids, reports, security measures, and the method of collecting stragglers. When elements of the battalions are to land in widely dispersed areas, the selection of company assembly areas may be delegated to the company commanders.
- (3) Data on the air movement, including the location of loading areas, allocation of aircraft, composition of the aircraft serials, and the times for loading, takeoff, and arrival at the objective area.
- (4) Data on marshaling. This may be issued in a separate order if it is lengthy and detailed.
- (5) Plan for reconnaissance after the landing, including reconnaissance for CBR contamination.
- (6) Plans for defense of the objective area after seizure of initial objectives, when applicable.
- (7) Plans for linkup with surface forces, if appropriate.
- (8) Details of air-sea rescue, when applicable.
- (9) Details of time and place of arrival and the use of troops and equipment in the followup echelon, when applicable.
- (10) Organization of, and instructions to, the rear echelon.
- (11) Supply and evacuation plan, including the method of recovering supplies and special measures for air resupply and air evacuation.

- (12) Alternate plans for accomplishing the mission.
- (13) Plans for other subsequent operations.

193. Reconnaissance

The company commander should make an aerial reconnaissance of the objective area and the routes to the objective area whenever conditions permit. If an aerial reconnaissance is not possible, his reconnaissance consists of a study of maps, terrain models, and photographs of the objective area. Other information of the terrain and enemy may be available from higher headquarters. The following items are particularly important in an airborne assault for the formulation of the ground tactical plan and landing plans:

- a. Nature of landing zones or drop zone, as appropriate, to include anti-airborne obstacles.
- b. Nature of assembly area(s).
- c. Location of key terrain features held by the enemy in or near the company's area of operations.
- d. Location and types of obstacles in the area of operations.
- e. Nature of the objective and the location of terrain suitable for defending the objective.
- f. Location of enemy units to include reserves and armored forces.

194. Organization for Combat

The company may be reinforced, particularly if it has a mission requiring physical separation from the remainder of the battalion. Attachments are made early during marshaling to give the company commander time to coordinate the use of his attached units and to control their preparations for the movement and subsequent action. The company may be divided into assault, followup, and rear echelons.

Section III. JOINT AIRBORNE OPERATIONS—PLANNING

Note. Wherever the term airborne operation is used in this section, it is construed to mean joint airborne operation unless otherwise indicated.

195. General

Based on battalion plans and orders, the company commander prepares his plans for loading, air movement, landing, reorganization, and the accomplishment of the tactical mission. Normally the ground tactical plan is prepared first; and based on this plan, the landing and reorganization plans are formulated; followed by the plan for air movement and marshaling, in that order. Although planning follows this general sequence, all plans are closely inter-

related and are often developed concurrently (par. 186). At company level all of the above listed plans are normally incorporated in a single plan.

196. Ground Tactical Plan

a. General. The ground tactical plan includes the assault plan to seize the assigned objectives, plan for defense of the assigned portion of the objective area, fire support plans to accompany both the assault and defense, plan for subsequent offensive operations, linkup plan, and plan for withdrawal, as appropriate (par. 211). Plans should be simple and flexible. Alternate plans are prepared. Plans for the attack and defense are generally as described in chapters 3 and 4, modified by the following factors peculiar to the airborne assault:

- (1) The possibility of becoming engaged immediately upon landing, before individuals and equipment can be completely assembled.
- (2) Limited artillery support. The company may have to attack before the artillery and, in some cases, the heavy mortar section have occupied firing positions. The dispersion of units in the objective area may limit the amount of artillery fire support which can be furnished the company.
- (3) Greater separation of units, resulting in more exposed flanks and rear.
- (4) Limitations on available ammunition and other supplies.
- (5) Limited mobility.
- (6) Nonavailability of tanks.
- (7) Confused tactical situation, with both friendly and enemy forces lacking information of the other.
- (8) Enemy normally surprised initially.
- (9) The objective area often relatively free of prepared enemy defenses and possibly without well-organized enemy combat troops initially.
- (10) Loss of a portion of company elements because of inaccurate aerial delivery or loss of aircraft during movement.

b. Assault Plan (fig. 30).

- (1) The assault plan consists of a scheme of maneuver and a plan of fire support. It is designed to capitalize on the surprise gained by the assault landing and to provide for rapid seizure of the assigned objective(s). The scheme of maneuver provides for seizing the assigned objective(s) and clearing the assigned zone of responsibility when directed. In a parachute assault, the company

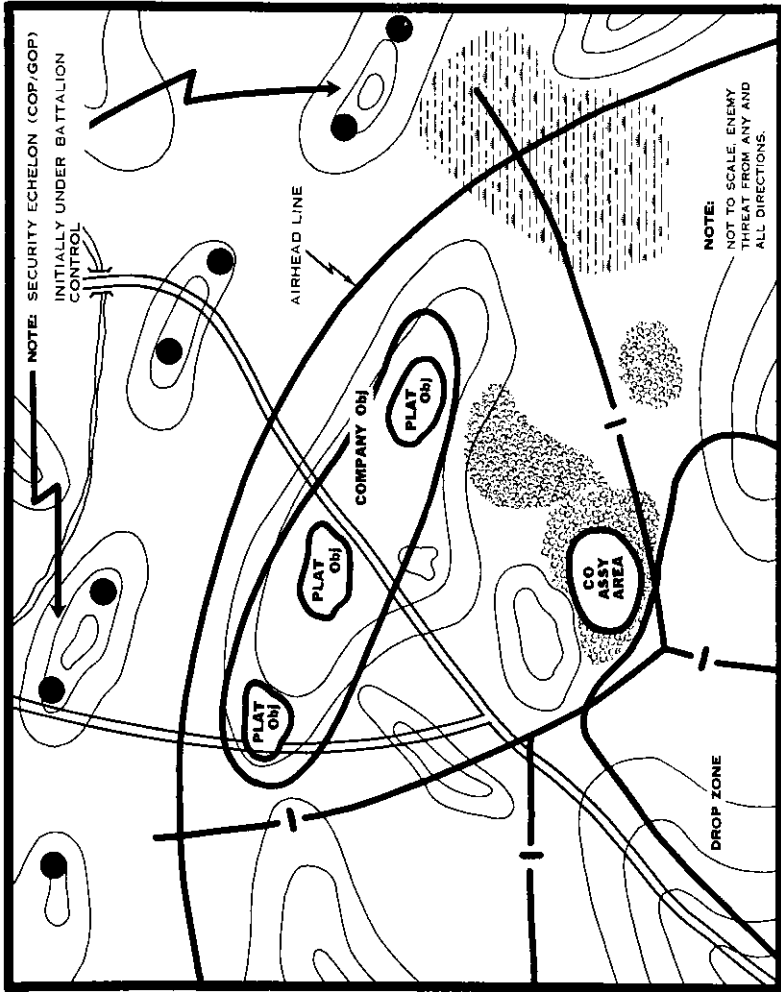

Figure 30. Rifle company, airborne infantry battalion in parachute assault (schematic).

normally assembles and reorganizes in its assembly area and attacks to seize its objective immediately. The company may be directed to attack before it is completely assembled. In an airlanded operation, the assembly and reorganization of the company may not be necessary. An attack position and line of departure are seldom used. Platoon objectives are selected to insure the seizure and control of the assigned company objective(s) and to accomplish other missions. Normally, intermediate objectives are not assigned because the company usually lands close to its objective(s). Whenever possible, a reserve is retained in the initial attack to provide a means of influencing the action. This may not be possible if a number of objectives must be seized simultaneously.

- (2) When the company is assigned more than one objective, the commander may prepare alternate plans to provide for seizing all objectives at the same time or in succession, as indicated by the enemy situation at the time of attack. If the objectives are lightly held, it may be possible to seize them simultaneously and thus accomplish the mission quickly. If the objectives are well-defended, it may be necessary to concentrate the combat power of the company against one of them at a time.

c. Defense Plan (fig. 31). When the operation has a defensive phase, the company is normally assigned a portion of the airhead line to defend. The company defensive area is designated by boundaries and coordinating points. The organization of the defense is similar to that discussed in chapter 4. Because the area to defend will frequently be large, mutual support between platoons and companies may be limited. Platoons are located to protect key terrain features and cover the most likely avenues of approach into the company sector of responsibility (par. 206).

d. Fire Support. The company commander prepares fire support plans generally as described in chapters 3 and 4, concurrently with the preparation of the assault and defense plans. Greater dependence will frequently be placed on close air support because of initial shortages of artillery. Close coordination of all supporting fires is necessary particularly with respect to linkup.

e. Linkup. When the plan of operations calls for a linkup with ground forces, the company commander insures that coordination measures are circulated and carried out by members of the company. The measures may include coordination of schemes of maneuver, coordination of fires, a system of mutual recognition, and coordination of communication, paragraph 211e.

f. Withdrawal. When the plan of operations calls for a

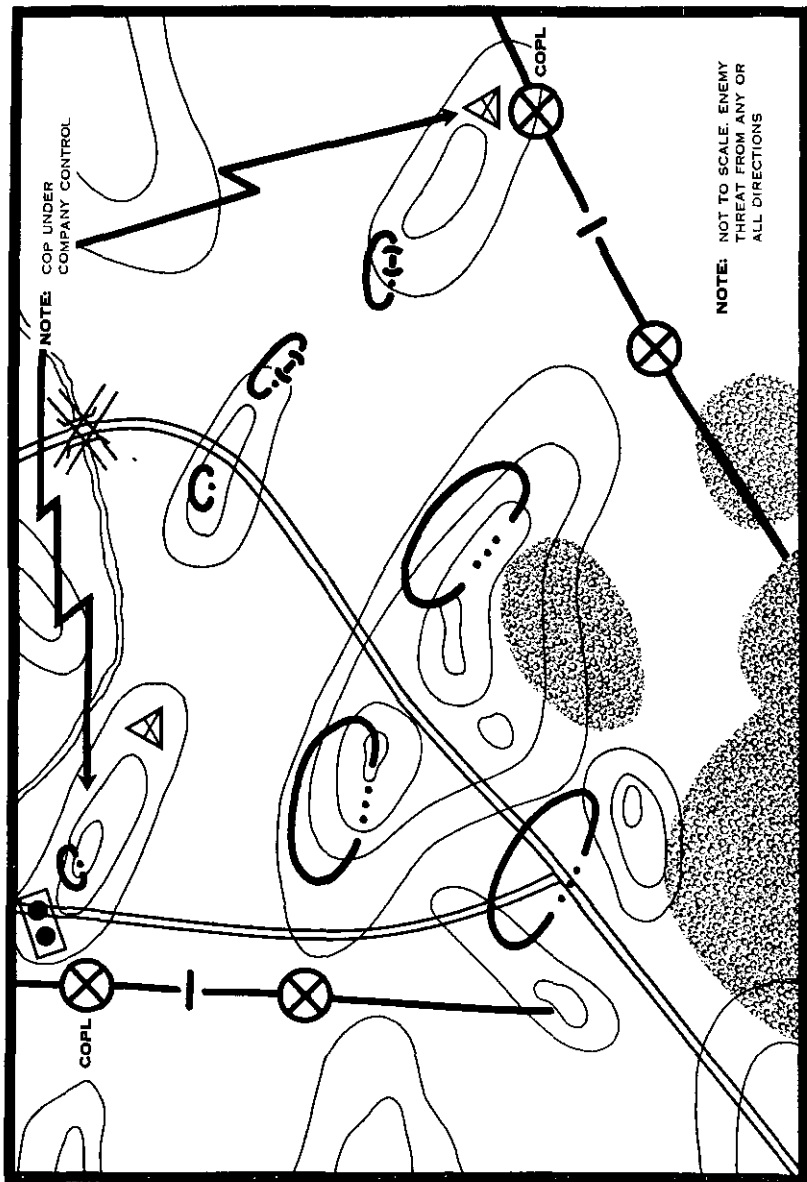

Figure 31. Rifle company, airborne infantry battalion in defense of an objective area (schematic).

withdrawal after the assault phase, plans for the withdrawal are prepared in as much detail as possible before the operation starts, paragraphs 220 through 225.

197. Landing Plan

a. The landing plan is based on the ground tactical plan. The battalion commander normally specifies the drop zone(s) or landing zone(s) to be used by the company or its elements. The company commander may assist in the selection to insure that the areas can be used to further his ground tactical plan. As a general rule, drop or landing zones are selected as close to the objective as the terrain and enemy situation permit (FM 7-20).

b. In an airlanded operation, a company assembly area may not be necessary; in a parachute operation, an assembly area is normally required. Normally, the battalion commander selects the company assembly area when he needs to coordinate the assembly of companies, as when more than one company lands on one landing zone or drop zone. When elements of the battalion land in widely separated areas, he often delegates the selection of the company assembly area to the company commander. Normally, only one company assembly area is designated, but one or more separate platoon assembly areas may be selected when the ground tactical plan makes it desirable. Alternate assembly areas are selected for use in case of unexpected enemy action. The company commander tries to choose an assembly area which—

- (1) Is free from enemy troops and small arms fire.
- (2) Is as close as possible to drop or landing zones.
- (3) Offers good concealment and cover.
- (4) Permits units to assemble in areas where they are favorably disposed for the attack, to include the nearness of weapons to their initial firing positions.
- (5) Permits units to assemble in the direction of their objectives.
- (6) Is large enough to accommodate the company.
- (7) Is easily identifiable by prominent landmarks.

c. Battalion may specify the use of certain assembly aids. The company commander specifies the use of other desirable aids, provided their use is not restricted by higher headquarters. Since the period of assembly and reorganization is critical, security may be sacrificed to a degree to use assembly aids that include panels, flags, colored smoke, and pyrotechnics to mark the assembly area during daylight; lights, pyrotechnics, and infrared devices to mark the assembly area at night; guides near the assembly area; radio-homing devices; audible signals such as tin crickets and whistles; and distinctive markings to identify personnel and

equipment of particular units. The most important step that can be taken to assure the success of the assembly and reorganization phase is to thoroughly orient personnel on the assembly plan.

d. The company commander plans for necessary security of the assembly area during reorganization.

198. Air Movement Plan

a. Air movement planning at company level consists essentially of preparing air loading tables and flight manifests. The company air loading table is forwarded to battalion for inclusion in the battalion air loading table. For preparation of the air loading tables and flight manifests, see TM 57-210.

b. In preparing the air loading table, tactical integrity of squads and platoons is maintained to the maximum extent possible. Critical command personnel, weapons, and communication equipment are distributed among several aircraft. Weapons and their crews are loaded in the same aircraft. Personnel are designated to recover equipment bundles upon landing. In airlanded operations, enough men are placed in each aircraft to unload cargo upon arrival at the destination. For directions for loading accompanying supplies, see chapter 2.

199. Marshaling Plan

a. The marshaling plan is based on the air movement plan which provides necessary information for determination of the date and time units are sealed, the personnel, vehicles, and the equipment to depart from each airfield or airlanding facility.

b. The marshaling plan covers movement of the company to departure airfields or airlanding facilities, responsibility for provision of certain facilities and services while units are marshaling, plans for loading of aircraft, and briefing of troops for the operation.

c. The marshaling plan at company level is based on the battalion marshaling plan and normally consists of plan for movement of the company, preparation of personnel and equipment for loading, loading of aircraft, and briefing of troops.

Section IV. JOINT AIRBORNE OPERATIONS—CONDUCT

Note. Wherever the term airborne operation is used in this section, it is construed to mean joint airborne operation unless otherwise indicated.

200. Marshaling

a. General. Marshaling is the process used to complete final preparations for combat, move to departure airfields or airlanding facilities, and load for takeoff. When marshaling begins, units are

sealed in marshaling areas or their assembly areas, and strict security is imposed. Marshaling is accomplished in the shortest time possible, usually less than 48 hours. Preparations are completed, including the finalization of plans, briefing of troops, and final preparation of supplies and equipment for aerial delivery.

b. Briefing. All troops are briefed in as much detail as time permits. Briefings are usually conducted at company, platoon, and squad level, using techniques described in FM 57-10. Personnel briefings stress the plan for reorganization because of its importance in regaining control after landing in the objective area. Terrain models, aerial photographs, and maps are used to familiarize all personnel with the area of operations so they can orient themselves quickly after landing. Company personnel are briefed on the plans of the battalion and the other companies involved in the operation so that in the event of inaccurate landings or unforeseen resistance, elements of the company may contribute to the accomplishment of the overall mission. Security is emphasized to prevent individuals from carrying copies of battle plans and orders into the objective area.

c. Preparation of Equipment for Aerial Delivery. For parachute operations, the preparation of accompanying supplies and equipment for aerial delivery is completed during marshaling. Aerial delivery containers, cargo parachutes, and related equipment are issued to elements of the company for packing equipment that is to be carried on individuals, delivered as door bundles, and dropped by monorail. Company men pack this equipment in the company assembly area. They mark the bundles distinctively to make them easier to identify and recover. Items to be delivered by heavy drop are normally prepared by personnel of the company under the supervision of trained teams from higher headquarters. Usually, this equipment is rigged near the loading site at times designated by higher headquarters. For a general discussion of rigging door bundles and loads for aerial delivery, see TM 57-210. Quartermaster technical bulletins and technical manuals of the 10-500-series contain specific data on rigging all vehicles, major weapons, and bulk equipment for aerial delivery.

d. Loading of Equipment. The company commander is responsible for loading his personnel, supplies, and equipment in accordance with the battalion loading plan. The company normally loads and lashes its supplies and equipment early, and loads troops at the last possible moment. Aircraft crews supervise and provide technical assistance in the lashing of equipment. The pilot and the ground commander inspect the loaded aircraft.

e. Loading of Troops. The company moves from the assembly area by plane loads to designated loading sites according to the

battalion plan. On arriving at the loading site, each planeload moves directly to its assigned aircraft and boards it.

201. Responsibility During Air Movement

The commander of the Air Force transporting aviation unit controls the air movement from the point of departure to the drop or landing zones. During this movement, the pilot is the aircraft commander and is in absolute charge of his aircraft, all crew members, and all passengers.

202. Landing

a. When the company is to go into action immediately, it lands on or as close as possible to its objective to achieve maximum surprise and to avoid unnecessary movement of troops, supplies, and equipment. It is desirable to land directly on an undefended objective. A landing directly on a defended objective increases the problems of reorganization and control. The company usually lands on a single drop or landing zone.

b. In parachute operations, heavy drop equipment and supplies are normally delivered on the same drop zone the company uses, but in some situations a different drop zone may have to be used. In heavy drop operations, recovery personnel jump immediately following heavy drop release, usually from the same aircraft, and with the equipment for which they are responsible. Recovery operations begin immediately after landing.

203. Assembly and Reorganization

a. The assembly and reorganization period during the initial assault is critical because of the company's vulnerability to attack. The operations are executed with maximum speed and precision. When necessary, security is sacrificed for speed and control.

b. When the company lands directly on or immediately adjacent to its initial objective(s), an assembly area is not normally used. Squads, platoons, and special teams proceed to their objectives immediately. In this type of assault, reorganization is accomplished concurrently with, or immediately after, the seizure of initial objectives.

c. When an assembly area is designated, individuals move directly to it. No attempt is made to assemble units on the drop or landing zone. In parachute operations, the men designated to recover supplies and equipment do so immediately and move to the assembly area. Radios are put into operation without delay.

d. If the company is engaged on the drop or landing zone, individuals return fire immediately. Leaders take control of groups of individuals, regardless of unit, and try to eliminate the enemy

force by small unit action. Aggressiveness is necessary in gaining control and in attacking the enemy force without hesitation.

e. Assembly aids are used as planned. If enemy action so requires, aids are set up to direct the troops to an alternate assembly area. Guides near the entrance to the assembly area direct individuals to their respective unit areas. Security is posted as planned.

f. Communication is established with battalion and within the company. Subordinate leaders keep the company commander informed of the status of their units during assembly and reorganization. They report the percentage of personnel, crew-served weapons, and equipment assembled.

g. If elements of the company land in the wrong area, they are assembled under the senior officer or noncommissioned officer present. If possible, he immediately establishes communication with the appropriate commander and requests instructions. Lacking orders, the group directs its effort toward accomplishing the company mission. Individual stragglers join the nearest unit and rejoin their own units as soon as the situation permits.

204. Initiation of the Attack

a. As soon as possible after landing, the company commander dispatches patrols to reconnoiter the objective. Based on what the patrols learn of the enemy, the company commander determines the extent of reorganization required before the attack is launched. Because of the surprise inherent in the airborne assault, it is frequently more desirable to start the attack early, when only a part of the company has been assembled, than to wait until assembly is more nearly complete. When patrol reports indicate that the enemy is prepared to defend the objective, it may be desirable for the company to assemble more completely before attacking. The decision to start the attack is normally delegated to the company commander. In some situations, the battalion commander retains the authority to make this decision so he can coordinate the action of all the battalion units.

b. When the company is assigned responsibility for establishing a portion of the security echelon during the assault phase, the assigned elements land either on or near the security positions or move forward to them as soon as possible. The primary mission of these elements during the assault is to provide early warning of enemy approaching the objective area.

205. Conduct of the Attack

The conduct of the attack is generally as described in chapter 3. The company commander modifies his original plan of attack

according to the degree of assembly of the company and newly acquired information of the enemy and terrain. Aggressiveness and rapidity of movement are necessary to capitalize on surprise. After seizing their initial objectives, elements of the company redispense themselves to defend the assigned sector or take whatever action is indicated by the mission.

206. Subsequent Operations

a. When the assault phase is followed by a defense of the objective area, the company normally defends a portion of the airhead line. The required dispersion may result in reduced mutual support between companies and between platoons. A security echelon (GOPL/COPL) is normally established as described in paragraph 204*b*. During the defense, the responsibility for the security echelon is normally assigned to forward companies. Antitank defense of the objective area is emphasized. For organization and conducted as described in chapter 3.

b. Subsequent offensive action, after the assault phase, is conduct of the defense, see chapter 4.

c. For a discussion of withdrawal from the objective area see paragraphs 220 through 225.

d. For employment of the surveillance section, see appendix IV.

Section V. AIRMOBILE OPERATIONS—GENERAL

207. General

a. While this section emphasizes the infantry rifle company conducting an airmobile assault and the defense of an objective area, it must be recognized that this is only one of the many ways that helicopters or other aerial vehicles can be used to provide increased battlefield mobility. For example, helicopters may be used to displace fire support units, to transport supplies, and to furnish a means of evacuation.

b. For further information on battalion airmobile operations see FM 7-20 and FM 57-35. In areas of conflict between this manual and FM 57-35, material contained herein will govern.

208. Employment

- a.* Some ways in which airmobile forces can be employed are—
- (1) Seizing key terrain in the enemy rear area for continued offensive action or until linkup.
 - (2) Conduct of raids.
 - (3) Flank security for a larger force.
 - (4) Bypassing enemy positions.
 - (5) Positioning units for flank attacks.

- (6) Transporting elements to reinforce, exploit, or counter-attack.
- (7) Dispersion of unit after seizure of objectives.
- (8) Bypassing obstacles.
- (9) Antiairborne and antiguerrilla operations.
- (10) Withdrawal of isolated units.

b. The infantry and airborne infantry rifle companies are particularly adaptable to airmobile operations because most of their equipment can be moved by currently available helicopters. The mechanized infantry rifle company can conduct airmobile operations minus its heavier equipment. A well trained company can conduct most airmobile operations on short notice.

209. Command Relationship

Normally the transport aviation unit is placed in support of the company with operational control retained by the battalion commander. The command relationship is based on the inability of the company to plan, coordinate, control, and support the air movement phase of the operation. For some independent operations, transport aviation elements and aircraft maintenance and supply elements may be attached to the company. See FM 7-20.

Section VI. AIRMOBILE OPERATIONS—PLANNING

210. General

a. Planning for an airmobile operation follows the sequence outlined in paragraph 188 and as described in paragraph 195.

b. In planning an airmobile operation dependence is placed on previously prepared SOP. Detailed SOP permit the company to conduct airmobile operations using fragmentary oral orders.

c. Although the planning for an airmobile operation parallels that for a joint airborne operation, it must be recognized that the plans will be less complex because of the size and scope of the operation.

211. Ground Tactical Plan

a. *Airmobile Operation.* The ground tactical plan for an airmobile operation is generally as described in paragraph 196.

b. *Scheme of Maneuver.* In developing the scheme of maneuver for the assault and defense phases of the operation the company commander will consider the following (fig. 32) :

- (1) *Objectives.* Objectives are selected using the same considerations discussed in paragraph 54.
- (2) *Platoon zones of action.* Platoon zones are assigned by designating boundaries. The terrain should be divided

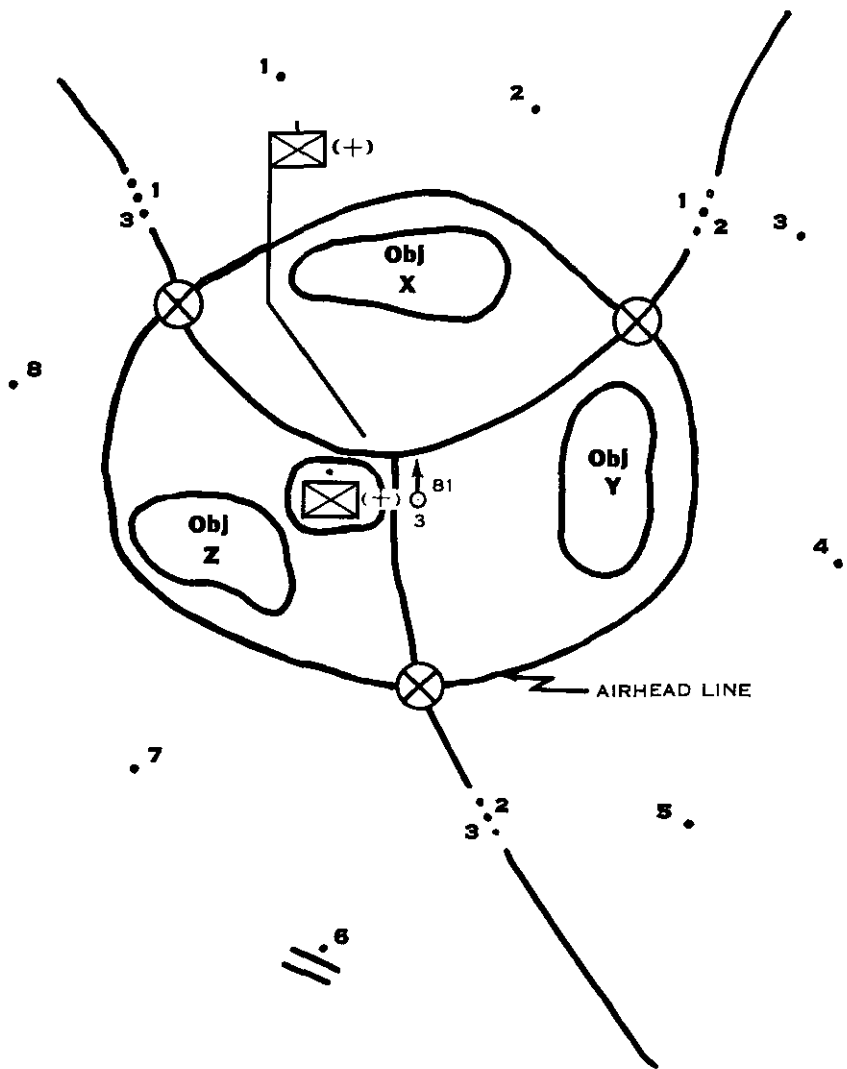

LEGEND:
 • SECURITY DETACHMENTS

NOTE:
 ENEMY MAY BE IN ANY OR ALL DIRECTIONS.

Figure 32. Scheme of maneuver (company land on or near its objective).

into zones and objectives selected in such a way that any given platoon will not have to attack simultaneously in different directions. Boundaries should be readjusted as little as possible during the transition from the assault to the defense. Each platoon has the responsibility of seizing the objective(s) within its zone, clearing the zone of enemy forces as required, and defending its assigned sector.

- (3) *Objective area.* The airhead line includes all of the objectives and maneuver space required for defense of the objective area. Coordinating points defining the airhead line, are designated on the boundaries to help define the zone to be cleared in the assault phase and to identify the sector to be defended in the defense phase. The trace of the airhead line may be indicated when required. When the assault phase and defense phase are shown on one overlay, coordination points and an airhead line are also portrayed. Normally, it is possible to select coordinating points suitable for both phases so that redistribution of assigned areas is not necessary.
- (4) *Security.* The security echelon for an airmobile operation is the same as for other defensive operations (par. 122). Appropriate security measures must be taken by the rifle company. These may consist of listening posts, observation posts, roadblocks, or other security detachments. Their locations are normally designated by the company commander. They are provided by the rifle platoons and attached elements, and are controlled by the platoon leader in whose zone they are located. The mission of these security detachments is to provide early warning and, within their capability, to delay and disorganize the enemy, and to deceive him as to the location of the airhead line. In order to better accomplish these missions, supporting elements; i.e., radar teams and anti-tank squads, may be employed with the security detachments. It is desirable for the security detachments to occupy their positions as early as possible to cover the assault phase of the operation. Security detachments normally land on their positions. Landing on position has the advantage of early establishment of security forces but does not insure clearance of the area between the airhead line and the security positions. Security detachments may be landed within the objective area and move out to their positions. Landing in this manner has the advantage of having the area between the security positions and the airhead line screened.

(5) *Employment of organic and attached units.*

- (a) One or more antitank squads from the battalion anti-tank platoon may be attached to the rifle company. They will normally be employed in general support of the company and will be positioned to cover armor approaches and to take maximum advantage of the terrain and the range of the weapons.
 - (b) The short range radar teams are employed in general support of the company in position areas from which they can provide surveillance coverage throughout the company area (app. IV).
 - (c) If engineers are attached, they perform appropriate engineer tasks such as constructing roadblocks, preparing or removing demolitions, and clearing or improving landing zones. Priority of work will usually be assigned to the security positions.
- (6) *Reserve.* To insure rapid seizure of the assigned objective area, an airmobile company commander may often determine it necessary to assign objectives to all of his rifle platoons. This requirement may not allow the company commander to initially withhold any part of his maneuver elements as a reserve. Platoons having assault missions are given reserve missions to be accomplished on order. Elements of company headquarters, attached units and fire support elements will comprise the reserve in these situations.

(7) *Defense.*

- (a) Normally, the boundaries and other control measures used for the assault phase will be suitable for the defense of the objective area. It may be necessary, however, for the company commander to make adjustments once he arrives in the objective area and has an opportunity to conduct a ground reconnaissance.
- (b) The defense of the airmobile objective area usually takes the form of the perimeter defense (pars. 144-146).
- (c) After the positions on the airhead line are completed, the company commander plans to move additional elements of the company to occupy positions forward of the airhead line. Such positions will serve to reinforce previously established security positions.

c. *Fire Support.*

- (1) Fire support plans are developed concurrently with the assault plan and defense plan.

- (2) The company commander of the airmobile force in coordination with the battalion staff, plans fires to be delivered prior to, during, and after the assault and in support of the defense of the objective area. He can expect to receive artillery, close air support, and suppressive fires delivered by Army aircraft. Nontoxic chemical agents may be used in the objective area in advance of the landing. Close coordination of all forms of fire support is essential. In addition to fires supporting operations in the objective area, provisions must be made to isolate flight routes by fire. See FM 7-20.
- (3) Desirably, organic fire support elements (81-mm mortars and the antitank section) are held in general support. They must be positioned so as to be able to support the entire perimeter.
- (4) For additional information concerning fire support planning, see paragraphs 60 and 132.

d. Landing Outside the Objective Area. In many situations, it will *not* be possible for the company to land on or near its objective. For example, enemy strength in the objective area may preclude the operation of helicopters near the objective. Additionally, the terrain on or near the objective may not be suitable for landing. In these situations, the airmobile force will be landed on a protected landing zone a reasonable distance from the objective and the company can then move on foot to attack the objective (fig. 33). When this is done, all-around security must be provided during the movement to the objective area. Provisions are made for defending the objective area until linkup as described in *b* and *c* above.

e. Linkup. Planning for linkup must be coordinated in advance and includes—

- (1) Coordination of schemes of maneuver (establishment of linkup points, delineation of objectives and boundaries or axes of advance, and location of a fire coordination line).
- (2) Assumption of command. Linkup will normally be accomplished by a larger force and the company will come under the control of the linkup force commander.
- (3) Command liaison with participating units.
- (4) A system of mutual recognition (arm bands, pyrotechnics, vehicle markings, and panels).
- (5) Coordination of communication plans (establishment of nets and exchange of radios, if required). See FM 7-20.

f. Withdrawal Plan. See paragraphs 220 through 225.

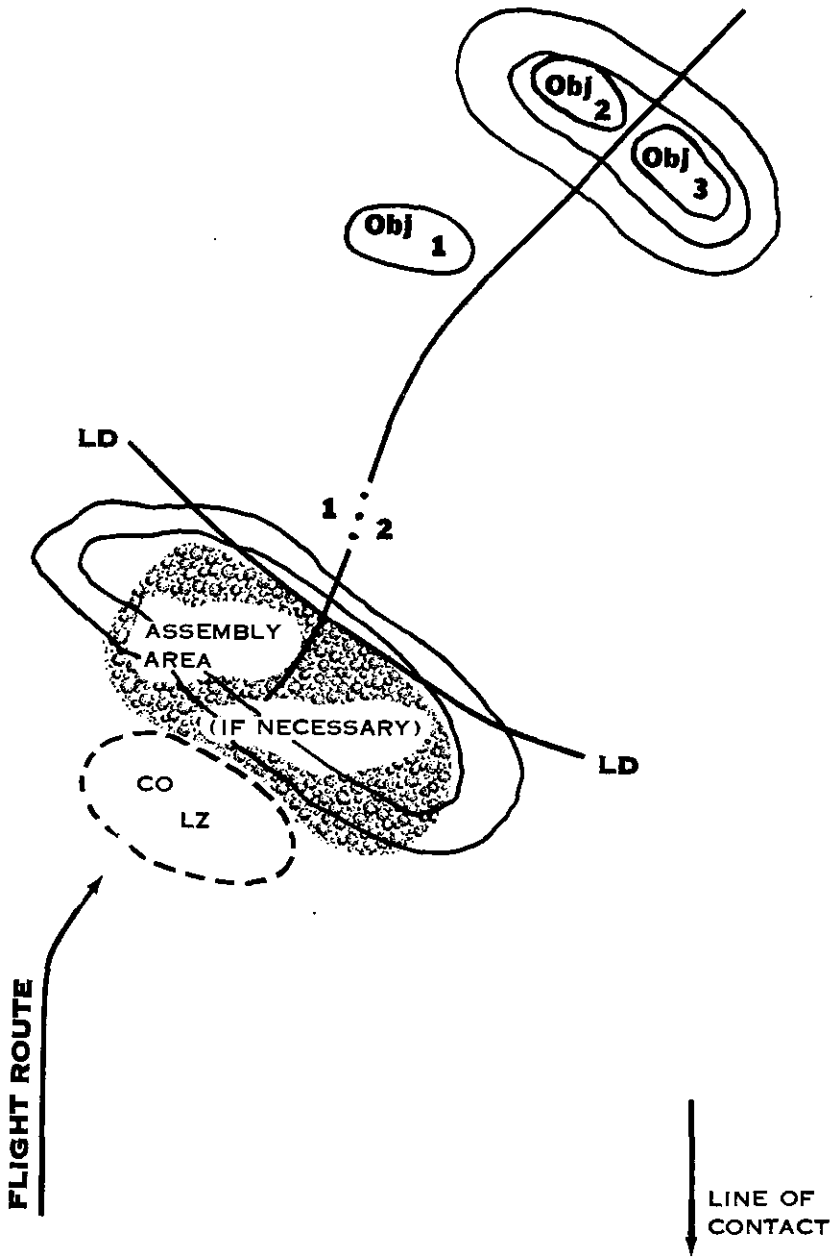

Figure 33. Scheme of maneuver (company unable to land on objective).

212. Landing Plan

a. Landing is based on the ground tactical plan. The company lands on or as close to its objective as the terrain and enemy situation permit (par. 197). Landing details include: the sequence, time and place of arrival of troops and material, and the control measures to be used. The company commander coordinates with battalion S2 and the representative of the supporting aviation unit when selecting landing zones if they have not been prescribed by battalion. Any significant enemy strength in the objective area may not permit use of landing zones which coincide with objectives. In this event, landing zones are selected outside the objective area and the airmobile force moves on foot from the LZ to the objective. Alternate plans are prepared when time permits.

b. Desirable characteristics of landing zones are—

- (1) Ease of identification from the air.
- (2) Proximity to concealment and cover.
- (3) Relative freedom from obstacles and enemy air defense fires.
- (4) Nearness to objectives, dominating terrain, covered routes of approach to objectives, good road nets, and terrain favorable for defense against armored attack.

213. Air Movement Plan

a. Air movement planning for an airmobile operation involves—

- (1) *Flight routes* (fig. 34). They are selected by the battalion or higher headquarters in coordination with representatives of the supporting aviation unit. They should be selected to follow recognizable terrain such as rivers, natural corridors, railroads, and roads. See FM 7-20.
- (2) *Flight corridor* (fig. 34). Friendly fires must be controlled to prevent inflicting damage on the aircraft. Flight corridors enclosing all flight routes to be used are therefore prescribed and all fires within the corridor are coordinated or restricted. (See FM 7-20.)
- (3) *Flight formation*. The flight formation for any given mission is influenced by technical as well as tactical considerations. Technical considerations govern the minimum flight safety precautions that must be adhered to. An important element for coordination (company commander and aviation support personnel) in this portion of the plan is that the flight units or serials are arranged within the formation to best support the plans for landing and consequently the ground tactical plan. (See FM 7-20.)

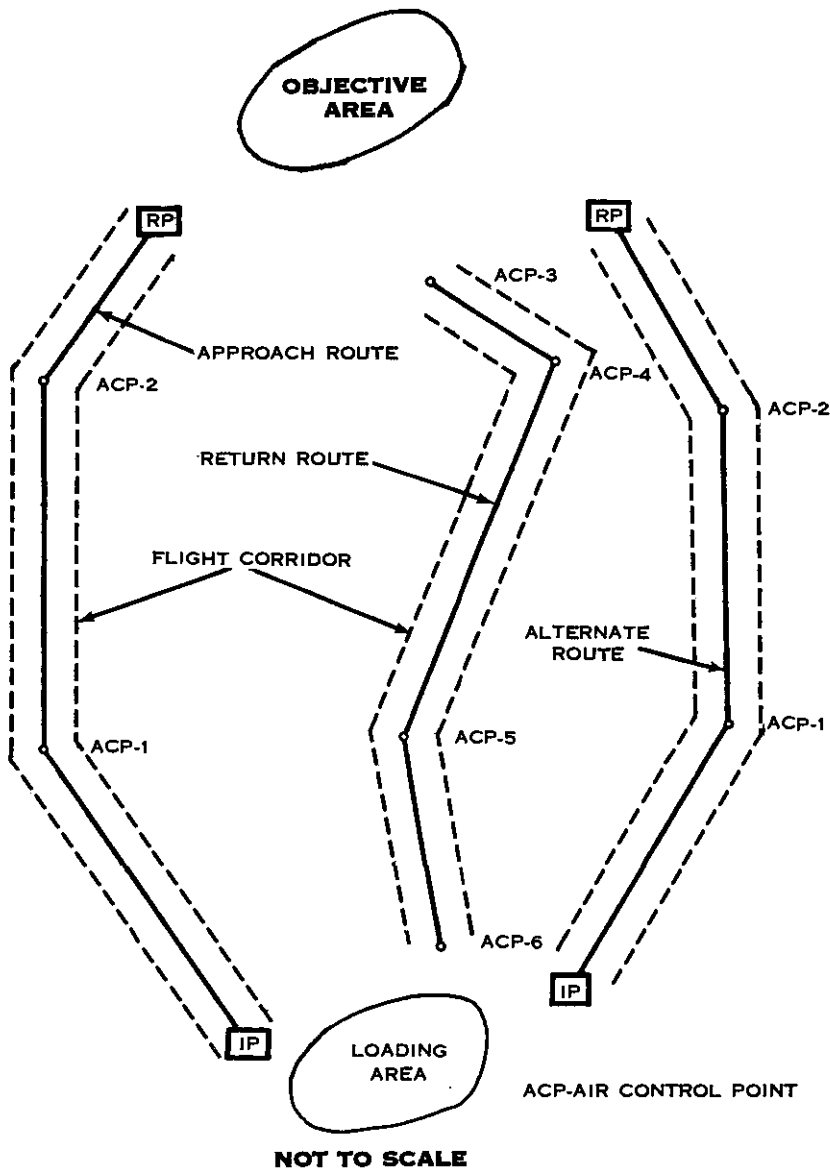

Figure 34. Flight routes and corridors (schematic).

b. Although less desirable, on occasion it will be necessary to move the company in more than one lift (shuttle). If this is necessary, the maximum rifle strength together with fire support, antitank, and security elements move in the first lift. When a landing cannot be made in the immediate objective area and a cross-country attack is necessary, it may be desirable for early lifts to await the arrival of succeeding lifts before beginning the

attack. In such cases, a defiladed landing zone and a concealed assembly area are preferable (fig. 33).

214. Marshaling Plan

a. The marshaling plan for an airmobile operation is generally the same as that for a joint airborne operation except that it is less detailed and complex.

b. Details of the marshaling plan are coordinated between the company commander and a representative of the transport aviation unit. These details include—

- (1) Exact touchdown site for each helicopter.
- (2) Chalk marks and/or loading formation.
- (3) Direction of flight.
- (4) Landing and directional aids to assist arriving aircraft.
- (5) Location of troops who will load aircraft.
- (6) Aircraft allowable cargo loads.
- (7) Procurement of necessary webbing for sling loads.
- (8) Preparation and hook up of sling loads.
- (9) Loading area security.

c. Loading is based on the plan for landing which, in turn, supports the ground tactical plan. For example, units with the most critical missions or which have the greatest distance to travel from the RP are transported in the leading flight. The mission is the paramount consideration. Tactical integrity, at least to fire team or weapons team, is maintained during load planning. Key personnel and equipment are distributed throughout the serial or flight unit. Care must be exercised, however, to insure that loading complements the landing plan so that aircraft routes do not cross one another after flights pass the RP.

d. Type loads can be prearranged by SOP. For example, four light or two medium transport helicopters are normally required to lift one rifle platoon. A company SOP can, therefore, prescribe exactly how each platoon will be loaded. Buffers for varying numbers of aircraft can be incorporated in the SOP by establishing a priority on vehicles which will accompany the airmobile force.

Section VII. AIRMOBILE OPERATIONS—CONDUCT

215. General

This section describes the marshaling, air movement, landing, assault, and defense of an objective area in hostile territory. It considers a rifle company conducting an independent airmobile operation in which the company:

- a. Lands on or immediately adjacent to its objectives.
- b. Lands a reasonable distance from its objective area and attacks cross country to seize the objective area.

216. Marshaling

a. Marshaling is conducted in or as near the assembly areas of the airmobile force as possible. Prior to the arrival of transporting aircraft, platoons accomplish those preparations for attack as described in paragraphs 50 and 51. In addition, special preparation applicable to airmobile operations are made. For example, vehicles are prepared for sling loading and personnel are briefed on loading and safety procedures.

b. Platoons are disposed in the loading area so as to permit quick loading of helicopters. Based on previous coordination with personnel of the supporting aviation unit, exact touchdown locations are established and marked (if necessary) for each helicopter.

c. Individuals who are not accompanying the airmobile force hookup sling loads in order to avoid unnecessary delays.

d. If communication security permits, unit or aircraft radios may be used to control loading, otherwise visual signals must be used. If possible, spare aircraft should be available in the event any aircraft aborts during the loading process.

217. Air Movement

a. The company commander is responsible for the conduct of the air movement. If necessary to control movement from the loading area(s), he uses unit personnel, pathfinders when available, and personnel and facilities of the supporting transport aviation unit. The commander of the supporting transport aviation unit advises and assists him by maintaining communication with the aircraft and by transmitting movement instructions as required.

b. Serials take off from the loading area by flights at the time prescribed. The takeoff and movement of the IP are executed so the flights arrive at the IP at the prescribed time and in the proper formation.

c. The company commander is kept informed of the progress of the loading and of any changes in serial composition, delays, etc., due to aircraft aborting prior to or on takeoff. This is particularly important during shuttle movements.

d. Flight routes are defined by air control points (checkpoints). Normally, the IP and RP are easily recognizable landmarks. They may be identified by visual or electronic devices, especially at night and during periods of low visibility. As many additional ACP's as are required for navigation may be designated and marked in a like manner. Pathfinders may provide the necessary personnel and equipment to mark these checkpoints.

e. The aviation unit commander is responsible for executing the flight as prescribed in the order. He keeps the company commander informed of progress during the flight and makes any recommendations he considers appropriate.

f. The battalion commander maintains contact with the column during flight, and transmits instructions as required.

g. Upon reaching the RP, flight units within the air column leave the column and proceed to the assigned landing zones. They may be guided either by pathfinders or airborne guides.

h. To reduce congestion in the landing zones and minimize the time aircraft are exposed to enemy fire while on the ground, they are unloaded rapidly and take off for return movement by flights without organizing into serials.

i. Flights return to the loading area over designated return routes. If an alternate route is to be used, necessary instructions are issued and coordinated with the FSC and other affected agencies.

218. Landing and Assault

a. The assault phase of an airmobile operation begins with the landing of the lead elements and continues through the seizure of the objective area and the occupation of the security positions.

b. When helicopters touch down, troops unload without delay and depart the landing zone immediately. Zones of action are cleared as necessary and units begin preparation of defensive positions. Security elements are dispatched to perform missions outlined in paragraph 211a(4).

c. In operations where the company must land some distance from the objectives, it may be necessary to reorganize in an assembly area prior to the attack. Since cross-country movement to the objective area takes place in hostile territory, increased security measures must be taken. Intermediate objectives, LD's, zones, and other control measures are selected and used as appropriate. Organic and attached fire support elements immediately take action to support the scheme of maneuver. Once assigned objectives have been seized, a perimeter defense is established.

d. One of the most difficult problems encountered by leaders during the landing is that of ground orientation. This problem can be partially solved by detailed map and aerial photograph study prior to the operation. In addition, all leaders must be aware at all times of the location of aircraft during flight in case of forced landing. Knowledge of the direction of landing assists leaders in orientation upon landing. Close coordination with pilots during flight is necessary. The pilot or crew chief can inform the troops the direction the helicopter is facing to assist in orienta-

tion. Additionally, if enemy activity has been observed while landing, the troops should be informed of such.

219. The Defense

a. Airmobile operations involving the retention of the objective area normally have a defensive phase. The period of time involved varies depending on the mission assigned, the size and composition of the force, enemy reaction, and the type operation contemplated.

b. Defense of the objective area employing the perimeter defense is accomplished by organizing and occupying the dominant terrain along the airhead line to cover main routes of approach into the position; covering unoccupied terrain between defended localities by fire, mines, and other manmade and natural obstacles; patrolling; and withholding a reserve. Enemy attacks are countered by shifting units, reinforcing threatened areas, employing massed fire support, and counterattacking. The interior lines of communication in the perimeter facilitate shifting troops, massing fires, and committing reserves, including units from portions of the airhead line not under attack. Reserves are held in positions of readiness prepared to counterattack, to occupy defense positions, or to execute blocking missions.

c. Continuing emphasis must be placed on improving and extending antitank defense in the objective area because of its vulnerability to enemy armor. Organic antitank weapons, manmade obstacles, natural obstacles, and close air and other available support must be used to maximum advantage.

d. After defensive positions are prepared, additional elements of the company may occupy positions forward of the airhead line to supplement security positions. Units withdraw to the airhead line only when ordered to or when forced by enemy pressure. The conduct of the defense from these forward positions is similar to the conduct of a delaying action.

e. For employment of surveillance section, see appendix IV.

Section VIII. WITHDRAWAL BY AIR

220. General

a. A withdrawal by air is an operation in which all or part of a deployed force disengages from the enemy and moves by aircraft to another location. A withdrawal by air from an objective area may be preplanned during the planning phase for execution when the mission has been completed, or it may be executed as a result of a change in the original plan or when forced by the enemy. It may be conducted by day or night. The rifle company can make a withdrawal by air as part of a larger force, or as an independent

unit after conducting an independent operation such as an airborne raid. In the latter situation, the tactics and techniques described below are modified to conform to existing conditions. See also FM 7-20.

b. Local air superiority is normally required for a successful withdrawal by air. In some situations, small forces may withdraw over short distances without air superiority when adequate fire support is available from outside the objective area.

c. Forces withdrawn by air normally move to assembly areas behind friendly lines, but they may move to another objective area or battle area.

221. Concept

a. To withdraw the majority of a force from an objective area, a part of the force must cover the withdrawal of the main body from contact, its movement to loading areas, and its evacuation. Normally, least engaged units are withdrawn and evacuated first under protection of the detachments left in contact. After the main body has been evacuated, the detachments left in contact break contact with the enemy and are evacuated, preferably by helicopter.

b. The composition of the detachments left in contact and the specific techniques used in covering the withdrawal vary widely, depending on such factors as enemy pressure and capabilities, fire support available, terrain, size of the objective area, availability of aircraft and landing facilities, conditions of visibility, and friendly air cover available. In some situations, such as when enemy pressure is light and his capabilities are limited, relatively light detachments left in contact may be left to cover the withdrawal. In other situations, strong forces may be required to withstand determined attacks delivered to disrupt the operation. The composition and strength of the detachments left in contact may also vary in different parts of the objective area.

c. Every effort is made to withdraw all personnel and equipment by air. However, enemy action will often prevent air withdrawal of some of the detachments left in contact. These forces use evasion and infiltration tactics to return to friendly lines or to meet aircraft at other locations. Equipment which cannot be evacuated is destroyed.

222. Planning

a. When the possibility of withdrawal by air is foreseen prior to an airborne operation, a withdrawal plan is included in the plan for the operation. The plan is revised as necessary and kept current during operations in the objective area. The company plan

of withdrawal is based on the battalion's plans or orders. The plan includes the composition of the main body and the detachments left in contact as well as the time and sequence for withdrawal. The following control and coordination measures may be used as appropriate: zones and/or routes of withdrawal, checkpoints, phase lines, assembly areas, loading areas, and loading control measures; coordination of fire support; communication instructions; and secrecy and deception measures.

b. The plan is as detailed as time permits. Because the tactical situation at the time of withdrawal cannot be accurately predicted during the planning phase, the plan must be flexible enough to permit adjustment required by unexpected enemy reaction, changes in aircraft availability, and similar contingencies.

c. Planning time may be reduced and greater efficiency achieved by establishing certain procedures in unit SOP's. Such items may include special communication measures, instructions for destroying equipment, procedures and control for aircraft loading, security measures, type aircraft loading plans, and general plans for evacuation of casualties.

223. Reconnaissance

Detailed ground reconnaissance of assembly areas, routes or zones of withdrawal, and loading areas is highly desirable. Reconnaissance is conducted by leaders down to the lowest level practicable. Guides are oriented and, when appropriate, routes are marked.

224. Organization for the Withdrawal

a. The battalion commander normally specifies the general strength and composition of the detachments left in contact. In some situations the company may be required to leave only a small number of security posts, while in other situations the entire company may be ordered to cover the withdrawal of other elements of the battalion.

b. All or part of the company may be designated as battalion reserve and assigned blocking or counterattacking missions to assist the withdrawal.

225. Conduct of the Withdrawal

a. *General.* The battalion commander orders the withdrawal and controls it to prevent congestion in the aircraft loading areas and to insure that adequate forces are covering the withdrawal. Normally, the least engaged units withdraw first. The withdrawal of various elements is timed so that units move to loading areas and board aircraft with a minimum of delay in assembly areas.

b. Techniques. The specific techniques of withdrawal used by elements of the company will vary.

- (1) Under certain conditions, the company may use the night withdrawal technique (pars. 168–172). This technique may be appropriate when the company is not under direct enemy pressure; when a degree of deception is possible, as when the company is one of the first units to withdraw; or when the company sector is protected by a formidable obstacle, or series of obstacles, that restricts enemy movement into the area. The company detachments left in contact usually consists of elements of each platoon, which redispense themselves as necessary to cover the major approaches into the company area. Elements of the main body of the company withdraw simultaneously as described for the night withdrawal. If this technique is used during daylight, smoke may be used to deny the enemy observation.
- (2) Under certain conditions, the company may use the daylight withdrawal technique (pars. 173–176). This technique is normally required when the company is under enemy pressure. The company reserve is redispensed as necessary to cover the withdrawal of the forward platoons. If the company has no reserve, elements of the battalion reserve may cover its withdrawal.
- (3) A modified version of the daylight withdrawal technique may be required when the company is under pressure, when there is no company reserve to cover the withdrawal of the forward platoons, and when no elements of the battalion reserve are in position to cover the withdrawal of the company. Such conditions may exist when the company is among the last elements to withdraw from the objective area. Under these circumstances, the company plan of withdrawal normally provides for the formation of detachments left in contact. This force is normally formed along a designated phase line by elements of each platoon. The company commander controls the withdrawal of the platoons based on enemy pressure and the availability of aircraft. He normally orders the least engaged platoon to withdraw first. The first elements of each platoon to withdraw occupy a position to the rear from which they can cover by fire the withdrawal of the remainder of the platoon. This platoon force, which is normally not larger than a reinforced squad, remains in its covering position and becomes part of the company covering force under company control, while the remainder of the platoon continues its with-

drawal to the assembly area. The platoon radio in the company command net normally remains with the platoon covering force. When the major elements of all platoons have broken contact and withdrawn, the company commander relinquishes control of the company covering force to a designated subordinate leader who, in turn, comes under battalion control.

c. Security. The company detachments left in contact provide the primary security for the company's withdrawal. The company commander specifies additional security measures to be taken during movement to and occupation of the company assembly area.

d. Control of Movement and Loading.

(1) The company assembly area for the withdrawal is prescribed by battalion if more than one element of the battalion is to be evacuated from one air landing facility. If the company is to be evacuated independently, the company commander selects the assembly area and advises the battalion commander of its location. The assembly area is normally adjacent to the air landing facility. The company commander prescribes platoon assembly areas, routes and/or zones of withdrawal, phase lines, checkpoints, use of guides, and other appropriate control measures.

(2) The schedule for loading aircraft is controlled by battalion or higher headquarters. Normally, the company commander designates the executive officer or another representative to control and expedite company loading in coordination with the loading control officer of higher headquarters. The executive officer or representative is located in the company assembly area. As elements of the company arrive, he insures that they are organized into planeloads and dispatches them to aircraft on instructions from the loading control officer. So far as possible, each planeload of personnel and equipment is organized and ready for loading before its scheduled aircraft arrives to minimize the time the aircraft must remain on the ground. When the enemy situation permits, teams may be designated to load and secure equipment in aircraft. When enemy pressure precludes the use of teams, the crew which operates each item of equipment normally loads and secures it and rides in the aircraft with it.

e. Action of the Detachments Left in Contact. The commander of the detachments left in contact comes under battalion control. The battalion commander coordinates all his detachments left in

contact to provide the best protection for the withdrawal of the main body. Because of the limited amount of space available within the objective area, the detachments left in contact normally defend in place; however, they may conduct limited delaying action in some situations. The detachments left in contact take maximum advantage of all available obstacles and fire to withstand attack. After the withdrawal of the main body is complete, the detachments left in contact are withdrawn and evacuated by available means. Aircraft (preferably helicopters) pick up elements of this force as near their positions as possible. When detachments left in contact cannot withdraw by air, they break contact with the enemy and use evasion and infiltration tactics to return to friendly lines or to meet aircraft at predesignated points for aerial evacuation.

CHAPTER 7

TACTICAL MOVEMENTS

Section I. INTRODUCTION

226. General

A tactical movement is one made under combat conditions when contact with the enemy is anticipated. The rifle company may participate in such tactical movements as movement to contact, movement away from the enemy, or other movements to relocate troops according to operational plans. During all tactical movements, the company must be prepared to react against ground or air attack, including CBR attack. The likelihood of enemy contact varies from remote to imminent, depending upon such factors as the distance of friendly forces from the enemy, the relative mobility of opposing forces, and the presence of friendly covering or security forces.

227. Missions

The company may be assigned a mission of providing security for the main body, such as advance guard, flank guard, or rear guard. The company may be required to attack, defend, or delay in order to accomplish its security mission, regardless of the type of operation being conducted by the main body (protected force). See paragraphs 232 through 243.

228. Formations

The formation adopted by the company is based on the imminence of enemy contact. When enemy contact is remote, troops are disposed in the column to facilitate ease of control, rapidity of movement, and administrative considerations. Adequate dispersion is maintained to provide protection from air attack and long-range artillery fires. As enemy ground contact becomes more probable, elements are grouped tactically in the column to facilitate prompt adoption of combat formations. The tactical grouping is based on the probable future employment of the company. When contact is imminent, troops are deployed in anticipation of enemy ground action.

229. Security

Depending on the terrain and the imminence of contact, security measures during movement may vary from observation to the use of security patrols. During short halts, sentinels, small security

detachments, and/or patrols are used to provide all-round security. During longer halts, additional measures taken may include the disposition of elements of the company to permit all-round defense. See paragraph 12.

230. Control

a. Positive control of the company depends primarily upon sound planning and adequate communication. All applicable communication facilities consistent with security considerations are used to assist in maintaining control. During movement, radio is the principal means of communication.

b. March objectives, routes, IP, RP, contact points, checkpoints, and phase lines may be used to assist the commander in controlling his unit. Unless otherwise specified, commanders report the arrival of their unit at these locations and continue the march without a halt. For a more detailed discussion of these and other control measures, see FM 25-10 and FM 7-20.

231. Night Movement

a. Night movement provides increased concealment, aids in maintaining secrecy, and may permit surprise. Rates of movement are generally slower at night than during daylight. Difficulty of control at night dictates more detailed planning and the use of more stringent control measures. Formations used are similar to those used during a daylight movement, but distances between individuals and units are often reduced because of the difficulty of control.

b. Other measures taken for control may include the posting of guides, marking of routes, marking of individuals for ease of identification, increased use of connecting files, use of infrared equipment for signaling, and the more frequent reporting of location by subordinate leaders.

c. Emphasis is placed on the maintenance of secrecy by rigid enforcement of noise and light discipline.

Section II. TACTICAL FOOT MARCHES

232. Rifle Company as Advance Guard—Mission and Organization

a. The mission of the rifle company as advance guard is to prevent unnecessary delay in the movement of the main body and to protect it from surprise attack from the front. The advance guard covers the deployment of the main body if necessary and, within its capability, denies the enemy ground observation of the main body from the front.

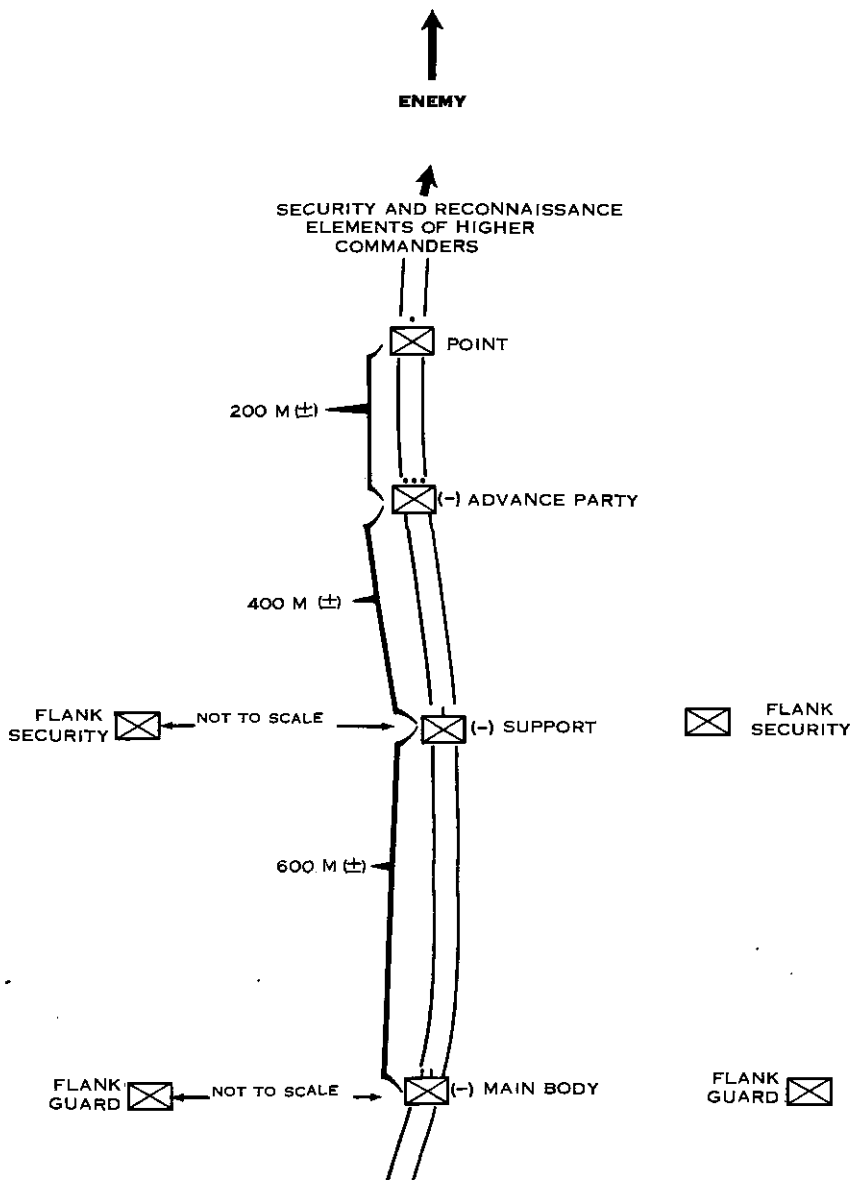

Figure 35. A type formation for a rifle company as an advance guard.

b. A motorized, mechanized, or airmobile security element, such as a reconnaissance unit, may precede the advance guard company initially. The advance guard company may be reinforced with tanks, antitank weapons, engineers, aircraft, or other elements to facilitate the accomplishment of its mission.

c. From front to rear, the advance guard company is organized into the point, the advance party, and the support (fig. 35). The

commander of the advance guard company sends forward a platoon as the advance party. The advance party commander sends forward one rifle squad to serve as the point. The advance guard company, less the advance party, is known as the support. Distances between elements of the company as indicated in figure 35 are guide figures only and will vary according to the situation, terrain, and visibility. These distances are prescribed initially by the commander of the advance guard company and should be great enough to allow each succeeding element to deploy without serious interference from the enemy once contact is made. However, the distances are not so great as to prevent each element from rapidly assisting the element in front of it.

233. Advance Guard Formation

a. Support Proper. The support normally moves in a column formation with elements arranged in the order of anticipated use.

- (1) Tanks are frequently attached to the advance guard, though seldom will more than a platoon be attached in a dismounted movement to contact. Tanks normally move by bounds, based on the recommendations of the tank unit leader.
- (2) Antitank weapons may be attached to the advance guard company. If tanks are also attached, the antitank weapons move with the support. If tanks are not attached, the antitank weapons may move with the advance party. In either case, they usually move by bounds.
- (3) An engineer platoon normally moves with the advance guard; one squad with the advance party and the remainder of the platoon with the support. An element of the squad with the advance party may travel with the point, searching for, and removing or marking mines. They also remove all other obstacles within their capabilities. Removal of large obstructions may require additional engineer effort. Engineer battalion reconnaissance parties may move with the forward elements of the advance guard to give timely warning of required engineer work.
- (4) The 81-mm mortar section normally moves on vehicle near the head of the support, prepared to occupy firing positions quickly when necessary. Conditions may warrant placing one mortar in position to provide immediate fire support and leapfrogging the remaining mortar squads forward as the advance continues. A mortar forward observer usually accompanies the advance party.
- (5) The ATGM squads are normally placed within the col-

umn where they can provide antitank protection for the support.

- (6) The company commander usually marches at or near the head of the support, although he moves wherever he can best influence the action. He may be accompanied by the weapons platoon leader, the artillery forward observer, an 81-mm mortar forward observer, and such leaders of attached or supporting units as he may specify.
- (7) Physical contact between the support and the advance party is maintained by connecting files sent forward from the support.

b. Advance Party. The advance party normally moves in a platoon column formation (fig. 36). The order of march is based on anticipated future employment. The advance party may be accompanied by the artillery FO and/or a CBR detection team. When an engineer reconnaissance team accompanies the advance party, it normally moves at the rear. The platoon leader moves wherever his presence is required. Connecting files from the advance party maintain physical contact with the point.

c. Point. The point moves in a squad column with about 10 paces between men. The distance between the leading two or three men may be increased to about 20 paces. The squad leader positions himself where he can best control his squad.

234. Conduct of the Advance Guard

a. Elements of the advance guard take maximum advantage of available concealment and cover, consistent with the prescribed rate of march. If the advance is along a road, for example, movement may be made along either side of the road to achieve maximum concealment from enemy ground and air observation. Care is taken that no enemy elements are bypassed.

b. Information of the enemy and terrain received from higher headquarters is immediately disseminated to elements of the advance guard. Similarly, such information obtained by elements of the advance guard is reported to the company commander, who in turn informs the battalion commander. Timely and accurate reporting is essential to permit commanders at all echelons to formulate effective plans for the employment of their units.

c. The point normally does not deploy elements to the flanks but relies on observation for security. The advance party also normally relies on observation for security but may use small, close-in flank security elements when necessary. The company commander specifies the measures taken to provide flank security for the support. Normally, foot detachments from the support operate on the flanks and abreast of the support, maintaining

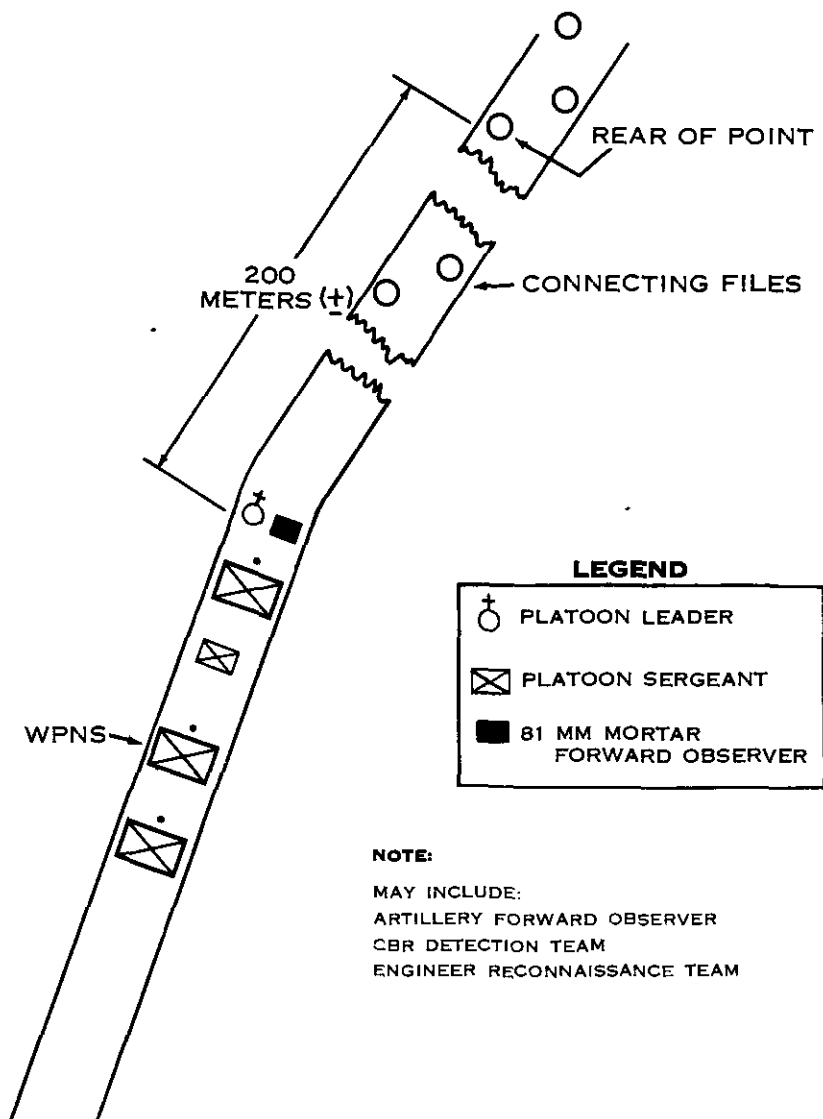

Figure 36. A type formation for the advance party.

contact by connecting files. Motorized or mechanized security detachments from the support are used when possible to screen likely enemy approaches until the advance guard has passed. The size of these detachments may vary from a fire team to a reinforced squad.

d. Advance guard actions are characterized by aggressiveness. Unless otherwise ordered, elements of the company attack without hesitation to drive off the enemy. Upon encountering enemy resist-

ance, the point returns fire immediately, deploys, and attacks. The advance party commander moves forward, makes a reconnaissance and an estimate of the situation, and determines where best to commit the advance party if the situation warrants. If the point does not succeed in reducing the enemy resistance, the advance party commander attacks with his entire party. He uses all available firepower, moving his supporting weapons forward to firing positions. He makes every effort to attack by a quick flanking maneuver rather than frontally. The company commander moves forward for his reconnaissance and estimate of the situation. When the situation warrants, he commits the entire advance guard to strike the enemy by maneuver against his flank or rear. If the advance guard is unable to reduce the enemy resistance, it immobilizes him by fire and locates his flanks to provide the battalion commander with information upon which to base his plan of attack. For additional discussion of offensive techniques, see chapter 3. When the enemy withdraws or is destroyed, the advance is promptly resumed.

235. Rifle Company as Part of the Main Body

The rifle company moving as part of the main body normally moves in column formation with approximately two paces between individuals. The leading company maintains the rate of march prescribed by the battalion commander; other companies maintain their position in the column. The company may be ordered to furnish flank security elements for the main body. Crew-served weapons which are not employed on security missions, generally move on vehicle. The commanders of the companies comprising the main body usually move at or near the head of their respective units. The battalion commander keeps them informed of the situation to the front and flanks to permit timely planning should their units be committed.

236. Rifle Company as Flank Guard of a Large Force

a. The mission of a flank guard company is to protect the main body from hostile ground observation and surprise ground attack from the flank. When attacked from the flank, the flank guard takes action to keep the main body from being delayed in passing from the area or to give the main body time to deploy and maneuver.

b. The flank guard company may be reinforced by tanks or anti-tank weapons and engineers. Special material such as antitank mines, demolitions, and special means for constructing obstacles may be made available.

c. The responsibility assigned to a flank guard company may

be designated as a series of terrain features that block likely enemy approaches into the flank of the main body, or may be designated as the flank of a specified unit. As the flank guard of a larger unit moving in column, the flank guard company's responsibility must be delineated by the commander assigning the mission. When the size of the area of responsibility and the number of approaches make it impossible to block all of the approaches effectively, the flank guard company blocks the most critical approaches and maintains surveillance over the remainder of the area.

d. The flank guard company operates far enough from the main body to insure accomplishment of the assigned mission. Normally, it stays within range of the heavy mortar platoon of the main body.

e. The formation used by a flank guard is designed to meet enemy threats at any point on the protected flank. When the area of responsibility is extensive and the platoons of the flank guard are widely separated, 81-mm mortar squads, antitank squads, and/or other elements may be attached to the platoons for additional support. When the company is less widely deployed, these weapons may be kept centrally located under company control ready to fire or move to meet enemy threats wherever they occur. During movement, the leading platoon (frequently reinforced) of the flank guard organizes and operates like the advance party of an advance guard.

f. The selection of screening positions for the flank guard is coordinated by the flank guard company commander with the protected unit commander. These positions are astride likely enemy avenues of approach. They are occupied on order or when enemy action dictates. The positions may be occupied by a platoon or the entire flank guard.

g. The movement of the flank guard is based on the movement of the protected unit. The flank guard occupies successive screening positions on order or as required, advancing when possible by leapfrogging its elements. It maintains close liaison with the protected unit by radio and with patrols (normally motorized). When the main body halts, the flank guard occupies screening positions which best protect its flank.

h. Army aircraft are used frequently to maintain flank surveillance and assist the flank guard by reporting information of the enemy and the terrain to the front and flank. Reconnaissance elements from higher echelons may operate to the front or flank of the flank guard company.

i. Because of the requirement for rapid movement, a flank guard mission is extremely difficult for a dismounted force to accomplish effectively. For this reason, a flank guard company may be motorized, mechanized, or provided with helicopter transportation.

237. Rifle Company as a Rear Guard

The rifle company may be assigned the mission of rear guard of a larger force. The rear guard prevents enemy interference with the main body by stopping or delaying enemy forces attacking the rear and by preventing enemy direct fire and ground observed indirect fire from harassing the main body. The rear guard is organized like the advance guard except that it is oriented toward the rear. Enemy action may force the rear guard to deploy in width to conduct effective defensive or delaying actions. For a discussion of delaying action, see chapter 5.

238. Rifle Company as a Screening Force

a. The rifle company may be assigned the mission of a screening force for a larger force. The screening force secures, by surveillance, an extended frontage to the front, flank, or rear of the larger force when it is moving or stationary. The screening force provides early warning by observing, reporting, and maintaining visual contact with the enemy forces encountered. The screening force is not expected to engage in close combat because its combat power is dispersed over an extended area. When enemy action forces the screening force to withdraw, it withdraws to successive screening positions, maintains visual contact with the enemy, reports the enemy's strength, disposition, and movement, and harasses the enemy's advance with supporting mortar or artillery fire.

b. To establish a screen, the company commander selects a series of screening positions which afford wide, deep, and overlapping fields of observation covering the enemy avenues of approach.

c. Each screening position requires the minimum forces necessary to maintain observation and to conduct patrolling between the positions. Each position should be provided a radio for communication. The screening force's area of responsibility is designated by the commander assigning the mission.

Section III. TACTICAL MECHANIZED OR MOTORIZED MOVEMENTS

239. Rifle Company as Mechanized Advance Guard

a. The rifle company as a mechanized advance guard may be preceded initially by reconnaissance elements of a higher unit. The advance guard commander may maintain contact with the reconnaissance elements by radio or by motorized or mechanized patrols.

b. The organization for the company as a mechanized advance guard is generally the same as that of an advance guard conduct-

ing a foot movement. The company commander sends out an advance party which precedes the support by a time interval that will permit the support to deploy when required. The time interval is usually about 5 minutes, but will vary depending on the enemy and the terrain. It should not be so great as to prevent the advance guard from assisting the advance party if necessary.

c. The advance party may send out a point, depending primarily on the enemy resistance anticipated and the availability of vehicles for this purpose. If a point is established, the use of two or more vehicles is desirable to permit movement by bounds. The point precedes the advance party by about 2 minutes, but this time interval will vary. The point should be provided with a radio.

d. Tanks are normally attached to the company for a mechanized advance guard operation. A tank platoon, adequately reinforced with infantry, may be designated as the advance party. Because of their armor protection and firepower, tanks of the advance party normally lead, though they are seldom separated from the advance party to act at a point. Tanks and infantry must be positioned within the formation so that they can closely support each other.

e. Other elements, including fire support elements, are positioned in the formation generally the same as for a dismounted advance guard operation. The distance between vehicles within the support is prescribed by the company commander and depends on the visibility, the terrain, and enemy capabilities. Forward observers normally accompany the advance party and the company commander to facilitate calling for and adjusting fire.

f. The point (if used) and advance party normally do not deploy elements to the flanks, but rely on ground and aerial observation and reconnaissance by fire for security. The support normally provides its own flank security with mechanized patrols. Air guards are posted in all vehicles. See also paragraphs 229 and 234.

g. While rapidity of movement is desirable, security considerations cannot be disregarded. Increased security is obtained when lead elements move by bounds rather than continuously.

h. When enemy resistance is encountered, the actions of elements of the advance guard are similar to those described for a dismounted operation (par. 234*d*). Close coordination and control are required to insure that elements of the column do not close on each other. When the column halts pending development of the situation to the front, vehicles are moved off the road to nearby concealment and local dismounted security established. For additional discussion of offensive techniques, employment of attached tanks and mechanized operations, see chapter 3.

240. Rifle Company as Mechanized Flank Guard

a. The discussion of a dismounted flank guard company in paragraph 236 is applicable to a mounted flank guard. However, a mechanized or airmobile flank guard, because of its ability to rapidly move elements to a critical locality, has greater flexibility than a dismounted flank guard and thus may be assigned a larger area to cover. If a sizeable enemy threat develops in an area under surveillance, elements of the flank guard are shifted to the critical area as required (par. 236*c* and *h*).

b. When the area of responsibility assigned to a mechanized flank guard company is large, considerable separation of platoons may result. To permit their semi-independent operation, rifle platoons are often reinforced with mortars, antitank squads, and other attachments to provide them with adequate direct and indirect fire support and antitank protection.

c. When the rate of movement of the main body permits, the platoons of the flank guard occupy a series of screening positions as described in paragraph 236. As the main body advances, the rearmost platoon leapfrogs to occupy the next position. This method is desirable since most elements of the flank guard company are in position at all times. When the movement of the main body is rapid, continuous movement of the flank guard may be required. The distance between platoons of the flank guard is based primarily on the area of responsibility, enemy threats, and the location of critical areas along the route. Elements of the flank guard are prepared to occupy positions immediately to counter enemy action from the flank. When the main body halts, elements of the flank guard occupy screening positions which provide the greatest flank protection to the main body. Areas between occupied screening positions are screened as necessary.

d. The company commander designates specific responsibility for maintaining physical contact with the main body, for reconnoitering the area between the main body and the flank guard, and for flank security of the flank guard itself. These tasks may be assigned to platoons or may be accomplished by mounted detachments or aerial observers operating directly under company control.

241. Tactical Motorized Movements

The principles and procedures outlined above for mechanized movements generally apply to motorized movements performed by the rifle company. However, motorized movements to contact will be conducted only on rare occasions.

242. Motorized or Mechanized Detachments

The company or some of its elements may act as motorized or mechanized detachments to accomplish reconnaissance, security, and combat missions. When employed in this manner, these detachments may supplement units such as the battalion reconnaissance platoon and the division armored cavalry squadron. For a discussion of appropriate techniques, see FM 7-20.

243. Airmobile Detachments

The company or some of its elements may be used as airmobile detachments to accomplish reconnaissance, security, and combat missions. Aircraft will be placed in support of or attached to the rifle company for the accomplishment of these missions. The use of airmobile elements increases the capability of the rifle company to accomplish security and combat missions. For a further discussion of appropriate airmobile techniques, see chapter 6.

APPENDIX I

REFERENCES

AR 59-106	Operation of Air Force Terminals
AR 220-58	Organization and Training for Chemical, Biological, and Radiological Warfare
AR 220-70	Companies—General Provisions
AR 320-5	Dictionary of United States Army Terms
AR 320-50	Authorized Abbreviations and Brevity Codes
AR 385-63	Regulations for Firing Ammunition for Training, Target Practice, and Combat
AR 600-66	Report of Casualties Originating in Combat Areas
AR 735-35	Supply Procedures for TOE Units, Organizations, and Non-TOE Activities
FM 1-100	Army Aviation
FM 3-5	Chemical, Biological, and Radiological (CBR) Operations
FM 5-15	Field Fortifications
FM 5-20	Camouflage, Basic Principles and Field Camouflage
FM 5-21	Camouflage of Fixed Installations
FM 5-22	Camouflage Materials
FM 5-25	Explosives and Demolitions
FM 5-31	Use and Installation of Boobytraps
FM 5-135	Engineer Battalion, Armored, Mechanized, and Infantry Divisions
FM 5-136	Engineer Battalions, Airborne Division
FM 6-135	Adjustment of Artillery Fire by the Combat Soldier
FM 7-15	Infantry, Airborne Infantry, and Mechanized Infantry, Rifle Platoons and Squads
FM 7-20	Infantry, Airborne Infantry and Mechanized Infantry Battalions
FM 8-15	Medical Service, Infantry, Airborne, Mechanized, and Armored Divisions
FM 8-35	Transportation of Sick and Wounded
FM 17-1	Armor Operations; Small Units
FM 19-40	Handling Prisoners of War
FM 20-32	Land Mine Warfare
FM 20-33	Ground Flame Warfare
FM 20-60	Battlefield Illumination
FM 21-5	Military Training
FM 21-6	Techniques of Military Instruction

FM 21-10	Military Sanitation
FM 21-11	First Aid for Soldiers
FM 21-15	Care and Use of Individual Clothing and Equipment
FM 21-18	Foot Marches
FM 21-26	Map Reading
FM 21-30	Military Symbols
FM 21-40	Small Unit Procedures in Nuclear, Biological, and Chemical Warfare
FM 21-41	Soldier's Handbook for Nuclear, Biological, and Chemical Warfare
FM 21-48	Chemical, Biological, and Nuclear Training Exercises and Integrated Training
FM 21-50	Ranger Training
FM 21-60	Visual Signals
FM 21-75	Combat Training of the Individual Soldier and Patrolling
FM 21-76	Survival
FM 21-77	Evasion and Escape
FM 21-150	Hand-to-Hand Combat
FM 22-5	Drills and Ceremonies
FM 22-100	Military Leadership
FM 23-5	U.S. Rifle, Caliber .30, M1
FM 23-8	U.S. Rifle, 7.62-mm, M14
FM 23-15	Browning Automatic Rifle, Caliber .30, M1918A2
FM 23-25	Bayonet
FM 23-30	Grenades and Pryotechnics
FM 23-32	3.5-inch Rocket Launcher
FM 23-35	Pistols and Revolvers
FM 23-55	Browning Machineguns, Caliber .30, M1917A1, M1919A4, M1919A4E1, M1919A6, and M37
FM 23-65	Browning Machinegun, Caliber .50, HBM2
FM 23-67	Machinegun 7.62-mm, M60
FM 23-71	Rifle Marksmanship Course; Trainfire I
FM 23-82	106-mm Rifle, M40A1
FM 23-90	81-mm Mortar, M29
FM 24-18	Field Radio Techniques
FM 24-20	Field Wire and Field Cable Techniques
FM 25-10	Motor Transportation, Operations
FM 27-10	The Law of Land Warfare
FM 30-5	Combat Intelligence
FM 30-7	Combat Intelligence, Battle Group, Combat Command, and Smaller Units
FM 30-16	Technical Intelligence
FM 31-10	Barriers and Denial Operations

FM 31-15	Operations Against Irregular Forces
FM 31-25	Desert Operations
FM 31-30	Jungle Operations
FM 31-50	Combat in Fortified Areas and Towns
FM 31-60	River Crossing Operations
FM 31-70	Basic Cold Weather Manual
FM 31-71	Northern Operations
FM 31-72	Mountain Operations
FM 41-10	Civil Affairs/Military Government Operations
FM 55-37	Transportation Battalion, Infantry Division
FM 57-10	Army Forces in Joint Airborne Operations
FM 57-21	Headquarters and Headquarters Company, Airborne Division Battle Group
FM 57-35	Airmobile Operations
FM 61-100	The Division
FM 100-5	Field Service Regulations; Operations
FM 101-1	Doctrinal Guidance (U)
FM 101-10	Organizational, Technical and Logistical Data;
(Part I)	Part I—Unclassified Data
FM 101-31	Nuclear Weapons Employment (U)
TM 3-200-Series	U.S. Army Fallout Prediction Methods
TM 10-405	Army Mess Operations
TM 57-210	Air Movement of Troops and Equipment
TM 57-220	Technical Training of Parachutists
DA Pam 27-10	Military Justice Handbook
DA Pam 108-1	Index of Army Motion Pictures, Film Strips, Slides, and Phono-Recordings
DA Pam 310- Series	Military Publications Indexes (as applicable) Manual for Courts-Martial, U.S. 1951, with 1959 Pocket Part
TC 3-10	Defense Against V-Agents
TC 7-3	Functioning and Employment, Antipersonnel Weapon (CLAYMORE) M18 and M18A1
TC 8-1	Training in Emergency Medical Care
TC 101-1	Prediction of Fallout and Radiological Moni- toring and Survey

APPENDIX II

TROOP LEADING PROCEDURE

1. General

a. Troop leading procedure is the logical sequence of action a leader follows while preparing for and executing an assigned mission, making best use of his time, facilities, and personnel.

b. Troop leading procedure as discussed in this appendix is appropriate for all leaders within the company in all types of operations. Depending on the existing circumstances, the level of command, and the type of operation, some steps or elements may be accomplished before others. In some situations, all steps may not be required or may not be possible because of time limitations. Time is the governing factor in the application of the steps of troop leading procedure, and though all steps should be considered, the degree of consideration of each may vary. The sequence as outlined in paragraph 2 below is suitable for many situations. It is presented as a guide to assist the leader in making maximum use of the available time and means to prepare for and execute his mission. It may be modified as necessary.

2. Steps of Troop Leading Procedure

a. *Start of the Planning Process.*

- (1) On receiving the order from his next higher commander, the leader begins by planning the use of the time available. He allots a portion of the time for his own reconnaissance and planning and for the reconnaissance and planning of his subordinates.
- (2) He analyzes the mission assigned in order to insure a thorough understanding of the assigned and implied task(s) to be performed by his unit.
- (3) He next begins his estimate of the situation.
 - (a) He makes a terrain analysis on a map, sketch, or aerial photograph to determine the observation and fields of fire, concealment and cover, obstacles, key terrain features, and avenues of approach available in his area of operation and in adjacent areas.
 - (b) He studies the enemy situation, analyzing the enemy strength, locations, dispositions, and capabilities.
 - (c) He then develops courses of action which are analyzed and compared to determine which one offers the best assurance of success.

- (4) Based on this estimate, he formulates a tentative plan of action which serves as a basis for future planning. He announces it as guidance to individuals who will make recommendations on the employment of their units. For example, in the attack, the company commander tells the weapons platoon leader, the artillery FO, and attached tank platoon leader his tentative plan of attack.

b. Incidental Arrangements.

- (1) *Movement of the unit.* The leader must plan early for the movement of his unit, if appropriate, to include where, when, and how. Often the company commander arranges for the entire company to move from an assembly area under control of the executive officer. At other times, subordinate leaders must arrange for the movement of their own units. The leaders usually receive the order to start the movement while they are forward with their commander. Sometimes they can return and bring their units forward, while at other times they must send someone back with instructions for the second-in-command to lead the movement. The instructions should be explicit and should include information as to the new location, the route to be used, the order of march, the time of arrival, and dispositions in the new location.
- (2) *Reconnaissance.* The leader plans his reconnaissance so as to cover the desired area as completely as time permits. He may plan to coordinate with certain individuals at specified points and times. He plans which persons will accompany him. When time is limited, the company commander may assign specific reconnaissance responsibilities to his subordinates (such as the weapons platoon leader), directing them to make recommendations based on their reconnaissance. The rifle platoon leader may assign similar responsibilities to his platoon sergeant or weapons squad leader, as appropriate.
- (3) *Issuance of order.* The leader informs his subordinates as early as possible, when, where, and to whom he will issue his order. When the terrain and enemy situation permit, he plans to orient his leaders from a vantage point overlooking the area of operations. He may designate someone to guide the subordinate leaders forward.
- (4) *Coordination.* The leader plans to coordinate with adjacent unit leaders and with leaders or representatives of supporting units, units in contact, or other units with which he will come in contact during the operation. Many of these leaders will be present for the issuance of the

higher commander's order, and the leader can begin coordinating with them at this time. The leader also makes plans to meet these and other leaders at a later time. The purpose of the coordination is to exchange information on plans of operation to insure that there is no conflict between units.

c. Making Reconnaissance. On his ground reconnaissance, the leader continues the estimate process adjusting his courses of action as the results of his reconnaissance dictate, and selects the best course of action under consideration. He then selects or confirms, as appropriate, such items as objectives, phase lines, LD, defense areas, routes, weapons position areas, sectors of fire, and targets. He notes the effects of the terrain on his tentative plan, and he rejects, alters, or adopts appropriate portions of this plan accordingly. During his reconnaissance, he coordinates with adjacent and supporting unit leaders as planned.

d. Completing Plan. After completing his reconnaissance, the leader receives recommendations from selected subordinates, if appropriate. Based on their recommendations and upon his personal reconnaissance, he revises as necessary his initial estimate and his tentative plan, and completes his plan of action. He then prepares notes to be used in issuing his order.

e. Issuing Order. At the time and place previously designated, he meets his subordinates. He orients them on the terrain from a vantage point or, if this is not possible, uses maps, sketches, aerial photographs, or an improvised sandtable. He then issues his order, using the standard operation order sequence, and includes everything his subordinates need to know. He allows his subordinates to ask questions. He, in turn, determines if the order is understood by asking them questions.

f. Supervising Activities. The leader, with the assistance of his subordinates, actively supervises his unit to insure the order is carried out as intended. If he notes a deficiency or a misunderstanding, he takes immediate corrective action. The need for effective supervision cannot be overemphasized.

APPENDIX III

OPERATION ORDERS

Section I. GENERAL

An operation order is an order which sets forth the situation, the mission, the commander's decision and plan of action, and the details of execution needed to insure coordinated action by the unit. Warning orders, which contain advance information and instructions pertaining to future operations, are used to permit timely preparation and concurrent planning for action. When enough time is available, complete operation orders are issued. When time is lacking, the commander may issue fragmentary orders which contain only the necessary information and instructions required for one or more units to accomplish a mission. At battalion level and below, operation orders are habitually issued orally. A map overlay or a sketch is frequently used on connection with an oral order. To insure that operation orders are complete and uniformly issued, the following prescribed sequence is used by commanders and leaders at all echelons. Paragraph numbers and paragraph titles shown here are not normally stated in *oral* orders.

1. Situation

This paragraph contains information of the enemy and friendly forces that subordinates should know in order to accomplish their missions. Only pertinent information is included, as follows:

a. Enemy Forces. Information of the enemy pertaining to the operation, such as locations, dispositions, strength, activities, and capabilities.

b. Friendly Forces. Mission of next higher unit, location and missions of adjacent units, and missions of nonorganic supporting elements which may affect the actions of the unit.

c. Attachments and Detachments. Elements attached to or detached from the unit for the operation, including the effective time of attachment or detachment.

2. Mission

A clear, concise statement of the task to be accomplished by the unit.

3. Execution

This paragraph states the general plan for the conduct of the operation and assigns specific missions to each subordinate tactical element, including attachments.

a. The *concept of operation* is the commander's plan for the operation. It includes the scheme of maneuver and the use of fire support.

b. Specific tasks are assigned to each subordinate element, to include committed maneuver elements, organic supporting elements, attachments, and the reserve, in that order. In assigning an element its mission, attachments or detachments are indicated.

c. Coordinating instructions, which are included at the end of the paragraph, contain those tactical instructions which apply to two or more of the subordinate elements. (*Example*: line of departure, time of attack, control measures, provisions for troop safety, restrictions, etc.)

4. Administration and Logistics

This paragraph contains information or instructions pertaining to rations, ammunition, locations of distributing points, medical support, transportation, and other administrative and supply matters. Only necessary information is included.

5. Command and Signal

a. Special signal instructions, which include such items as pre-arranged signals and restrictions on the use of radio or other means of communication.

b. Location of the commander and command post during the operation.

Section II. EXAMPLE ORAL ORDER FOR COMPANY ATTACK

Note. The oral order is issued to all leaders including leaders of attached units and the artillery forward observer. Paragraph numbers and letters are omitted when this order is issued orally. The company commander would point out features on a map, sketch, and/or on the ground.

6. Situation

a. "*Enemy Forces*: There is an estimated enemy rifle platoon occupying HILL 388 and HILL 401. Indications are the enemy will continue defense."

b. "*Friendly Forces*: Our battalion attacks at 0600 tomorrow to seize the high ground approximately 5000 meters to our front. That's the ridge on which HILL 500 is located.

The 2d Bn 15th Inf on our right attacks at the same time and seizes HILL 497—here. Co C attacks on our left and seizes this hill to the left of our objective 3.

The artillery begins its preparation at 0545 and fires for 15 minutes.

The heavy mortar platoon will smoke objectives 3 and 4."

c. "Attachments: We have Lt Jones' tank platoon attached."

7. Mission

"Company A attacks at 0600 tomorrow to seize objectives 1, 2, 3, and 4. We will continue the attack north to seize the right portion of HILL 439 on order."

8. Execution

a. "Concept of Operation: We attack with the 1st and 2d platoons in the attacking echelon to seize objectives 1 and 2. 1st platoon on the right. The tank platoon initially supports by fire and then joins in the assault. 81's are in general support and will fire preparation on objectives 1 and 2."

b. "1st Platoon: Base platoon; seize objective 1 and continue attack to seize objective 4 on order."

c. "2d Platoon: Seize objective 2 and continue attack to seize objective 3 on order."

d. "Tank Platoon: Initially support attack on objectives 1 and 2 by fire; join the 1st and 2d platoons in the assault on my order. Support continuation of attack on objectives 3 and 4. Join assault on order."

e. "Weapons Platoon: 81's—general support from present position. Fire preparation on objectives 1 and 2 beginning 0555 and continue until shifted. Displace to rear objective 3 when seized.

Antitank section—General support from present positions. Initial targets on objectives 1 and 2. Displace to objective 1 when your fires are masked or on my order."

f. "Ground Surveillance Section: General support. Provide surveillance on right flank."

g. "Co Reserve: 3d Plat. Be prepared to assume the mission of 1st or 2d plat on order. Protect company right flank."

h. "Coordinating Instructions: Line of departure is line of contact."

9. Administration and Logistics

"Breakfast is at 0400 on present positions. We'll issue C rations for the noon meal then. All riflemen will carry an extra bandoleer of ammunition. Company Trains to the rear of HILL 338. The company aid post is in these woods near RJ 274."

10. Command and Signal

"Emergency signal to shift supporting fires—violet streamer. Initially, I'll be on HILL 339. The CP moves to the rear of objective 3 upon seizure.

The time is now 1515."

"Any Questions?"

APPENDIX IV

EMPLOYMENT OF COMPANY GROUND SURVEILLANCE SECTION

Section I. GENERAL

1. Introduction

a. Ground surveillance radar equipment provides the company with an added all-weather capability for battlefield surveillance. This equipment complements other combat surveillance and target acquisition means in the battalion. Its employment is closely coordinated with the employment of patrols, listening posts, observation posts, and with infrared and other sensory devices. Ground surveillance radar can provide observation from a given vantage point 24 hours a day and can detect targets and provide a much more accurate range and azimuth reading than is possible by eye estimate. By utilizing this all-weather, 24-hour capability inherent in ground surveillance radar equipment, the company commander can appreciably increase the effective use of fire support means.

b. While the radar equipment is an excellent means of obtaining information, it does not replace other surveillance means. Its primary advantage lies in its ability to complement these other means and to detect information with accuracy when other surveillance means cannot detect the same information. Although radar is used primarily for operations at night or under conditions of poor visibility (haze, fog, smoke, etc.), the radar equipment may also be used effectively during daylight as well. The capability of this equipment is such that its employment should not be restricted to a certain type of terrain, a rigid set of conditions, or to a few functional operations.

2. Capabilities

Short Range Radar AN/PPS-4.

a. The radar set AN/PPS-4 is a lightweight, man-portable, partially transistorized radar capable of searching for, detecting, and identifying moving ground targets such as personnel and vehicles within a radius of approximately 80 to 7800 meters. It is also capable of detecting certain large stationary features such as tanks, buildings, etc. Moving targets are detected by means of the Doppler effect, which is a comparison of echoes received simultaneously from a moving target and stationary objects near the target. Target detection is made possible by monitoring the pulse

returns of the target within a movable electronic "range gate." Moving targets and certain stationary features within this "range gate" produce a characteristic audio tone in the operator's headset and a deflection in the range extension meter needle. When a target is detected, information on the range, azimuth, and elevation of the target is shown on the equipment. If the radar is properly oriented, the operator can read this information directly from the equipment.

b. Power for the radar set is provided by a suitable 24-volt DC source (battery or generator). The generator is mounted in an acoustical case which effectively suppresses noise and inhibits detection. On an average still, quiet night, when the generator is dug in or placed behind a hill, its noise cannot be heard beyond approximately 50 meters. However, adequate ventilation must be provided for the generator. If absolute silence is required, batteries may be utilized.

c. One man can place the radar in operation within 10 minutes and out of operation ready to move within 5 minutes. To attain desired efficiency of operation and reduce the fatigue of team members, operators should alternate every 30 minutes.

d. Visibility, terrain, and weather have no significant effect on the range capabilities of the radar set as long as a line-of-sight exists between the radar set and the target. However, rain and wind may cause an increase in background noise which makes location of certain single personnel targets more difficult. The range capabilities of the AN/PPS-4 are as indicated below:

<i>Target</i>	<i>Maximum(meters)</i>	<i>Reliable(meters)</i>
Man crawling -----	2230	1300
Man walking or running ----	4400	3500
4 or 5 men walking -----	4400	3700
4 or 5 men running -----	7800	4400
Moving ¼-ton vehicle -----	7800	7800
Moving 2½-ton vehicle -----	7800	7800

3. Limitations

a. The minimum range of the AN/PPS-4 is approximately 80 meters. The AN/PPS-4 does not have a remote capability. Although the radar energy can penetrate light camouflage, smoke, haze, rain, snow, darkness, and light foliage to detect targets, it will not penetrate dense undergrowth, trees, and heavy foliage. The AN/PPS-4 has a line-of-sight capability only.

b. Ground surveillance radar is generally ineffective against aerial targets unless they are flying low enough so that background clutter is provided by trees or terrain. The radar is vulnerable to jamming, and electronic and other deception means.

4. Training

a. Radar operators acquire proficiency by receiving comprehensive training in the following:

- (1) Message writing.
- (2) Map reading.
- (3) Authentication procedures.
- (4) Use of communications equipment.
- (5) Use of compass.
- (6) Terrain evaluation.
- (7) Defense against electronic countermeasures.
- (8) Camouflage and concealment.
- (9) Use of generator equipment to recharge batteries.
- (10) Tactics and techniques of employment of friendly and enemy troops, weapons, and equipment.
- (11) Selection of radar equipment sites.
- (12) Emplacement, orientation, and operation of radar equipment.
- (13) Target identification practice.
- (14) Procedure for rendering reports of information acquired.

b. In the training of radar operators, emphasis must be placed on the practical work performed by the operator. Only through practice in identifying various objects under all conditions of weather, terrain, and visibility, can the operator reach peak proficiency. See appropriate Army Subject Schedule for further information on training of the ground surveillance section.

c. All commanders and other key personnel should be familiar with the capabilities, limitations, and methods of employment of ground surveillance radars. Periodic refresher training of these personnel should be conducted to insure a high level of knowledge concerning the radar equipment. Whenever possible, employment of radar equipment should be integrated into CPX's, field exercises, and other company tactical training.

5. Logistical Considerations

An important factor in the operation of radar equipment is the provision of an adequate power source. Since the equipment will be operating on either battery or generator power, it will be necessary to recharge batteries and/or obtain gasoline for the generator. While this logistical function is normally the responsibility of the section sergeant, the senior radar operator must take steps to effect resupply when necessary. Appropriate records of length of operation of equipment should be maintained by senior radar operators to insure timely resupply and maintenance for the power source.

Section II TACTICAL EMPLOYMENT

6. General Types of Tactical Functions

The ground surveillance section is capable of performing a wide variety of general tactical functions including the following:

a. Searching avenues of approach, possible enemy attack positions, assembly areas, or other sectors or areas on a time schedule, at random times or continuously, to report location, size, compositions, and nature of enemy activity.

b. Monitoring point targets such as bridges, defiles, or road junctions and reporting quantity, type of target, and direction of movement through the point.

c. Assisting in the adjustment of artillery and mortar fire.

d. Surveying final protective fire areas or barrage locations to permit timely firing.

e. Surveying areas of nuclear and conventional fires to detect enemy activity immediately after firing as an indication of firing effect. By surveying the periphery of nuclear effects and comparing this with previous surveillance, it may be possible to ascertain the extent and types of damage (e.g., tree blowdown), and thereby determine whether further neutralization by nuclear or conventional means is required.

f. Extending the observation capabilities of patrols by enabling them to survey distant points or areas of special interest.

g. Assisting the visual observation of units during daylight hours by making initial detection of partially obscured (haze) targets at long ranges.

h. Assisting in the control of units during a night attack.

i. Vectoring patrols or other units through barriers.

j. Communicating with adjacent units or patrols when radio silence is imposed. The use of surveillance radar in this task as well as those outlined in *h* and *i* above, may be accomplished when positive means of identification have been established and appropriate signals have been established in advance. Since the radar detects motion of an object and presents it as a sound, identification must be by a prearranged motion which produces a characteristic sound. By using a corner reflector which produces an easily recognizable signal, coded signals may be sent to the radar operator.

k. Determining the range to distant terrain features.

l. Increasing the effectiveness of fire support. When targets have been detected with reasonable certainty by radar, the fire support means may immediately take the target under fire. However, in the event that the type of target cannot be definitely established, the radar team can furnish range and azimuth information concerning the target so that illumination may then be accurately employed to establish which type of fire can best be used. Since radar equipment can accurately detect the density of enemy activity in a given area as well as the rate of enemy advance or withdrawal, this equipment may be used in determining the optimum time for employment of explosives, atomic demolition munitions, chemicals, or destructive fires.

7. Radar Surveillance Cards

To insure proper surveillance coverage of the battalion area, subordinate units will normally submit overlays to battalion indicating the area of coverage of surveillance means organic or at-

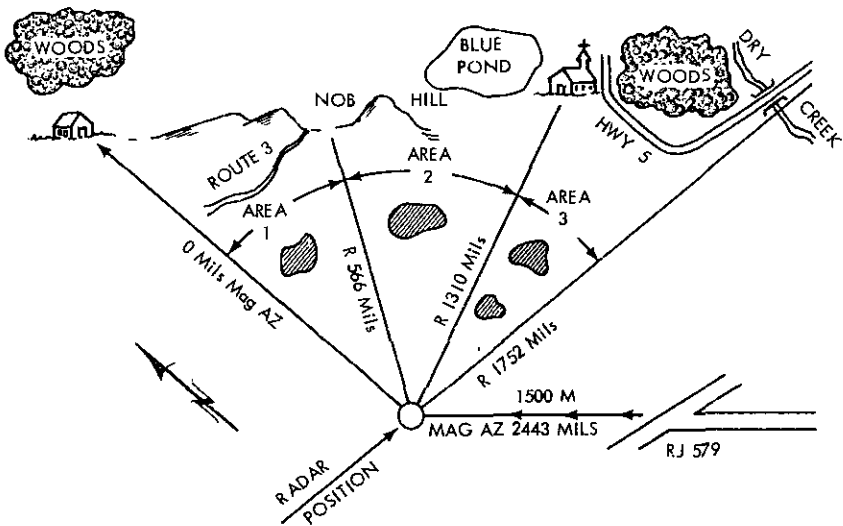

PRIORITY AREAS OF SEARCH

TIME	AREA	PRIORITY	RANGE	FREQUENCY OF SEARCH
0 TO +15	3	1	6000 M	AS ANNOUNCED
+15 TO +25	1	2	5000 M	" "
+25 TO +45	2	3	4000 M	" "

NOT TO SCALE

NOTE: AREAS OF DEAD SPACE



Figure 37. Radar surveillance card.

tached to them. Radar surveillance cards (fig. 37) may assist the commanders in preparation of these overlays. Such cards will normally be prepared by the senior radar operator immediately after the equipment is placed in position and will be distributed to appropriate fire support agencies. Radar surveillance cards are prepared for primary, alternate, and supplementary positions.

8. Selection of Radar Sites

The specific location of the radar equipment site is designated by the section sergeant or by the senior radar operator. This specific location must be within the general location designated by the company commander. The radar site should have as many of the following characteristics as possible:

- a.* Permit maximum radar coverage of the assigned area.
- b.* Provide concealment for the team vehicle and equipment.
- c.* Facilitate communications with the required units or agencies.
- d.* Take advantage of security provided by other company elements while avoiding interference with their operations. If possible, a position should be selected within a well established defense perimeter; however, since the enemy may have the capability of detecting radar signals and firing in that area, the location of radar equipment in the immediate vicinity of troop dispositions or key installations may be undesirable. In each case the factors of METT must be considered in positioning radar equipment.

9. Positioning of Equipment

a. Radars are normally positioned on dominating terrain. A radar site and an observation post may be located together; however, radar personnel should not be detailed as ground observers except in emergencies. To take advantage of the maximum range of the set, radars are employed as far forward as possible. Radar equipment is dug in and camouflaged, as in the case of a crew-served weapon, consistent with the requirements for operating the equipment. Radar equipment is positioned so its employment is closely tied in with the disposition and employment of other surveillance means.

b. The radar is located in areas relatively free of close ground clutter such as trees, bushes, or buildings. This clutter tends to distort the radar beam and will result in inaccurate range, azimuth, and resulting map elevation data.

c. The radar set is positioned in such a way that enemy use of electronic countermeasures can be minimized. In this respect equipment is dug in or emplaced so the antenna will receive signals from only the assigned surveillance area.

10. Orientation of the Radar Set

a. After the site is occupied, the radar set is immediately oriented and placed in operation. Then the site is improved and a radar surveillance card is prepared as time permits. The set must be oriented in azimuth and range and its position must be plotted on a map before the operator can pinpoint targets geographically. Orientation may be accomplished by inspection, resection, or intersection much as a soldier would orient himself on a map.

b. By a proper orientation of the set and coordination with fire support elements, moving targets detected by radar can be taken under fire by fire support elements using preplanned concentrations. Orientation and coordination of surveillance areas will be accomplished during daylight hours when feasible. In some instances, however, it may be more desirable to move radars into previously prepared positions under cover of darkness or poor visibility.

11. Operation of Equipment

a. Each radar team is assigned a specific area of surveillance. In assigning sectors, consideration is given to terrain, enemy capabilities, equipment capabilities, and desired degree of sector overlap. Sector surveillance assignments, type of surveillance to be conducted (scan, search, or monitor), how and when information is to be reported, and frequency of coverage must be included in the instructions to the radar team. The technique of scanning an area by radar is generally comparable to the scanning technique of a ground observer.

b. If enemy activity is detected in an area not included in the surveillance plan, a new mission may be prescribed redirecting the efforts of the radars. When such a mission is completed, the operator returns to the prescribed area of surveillance. The radar should be operated at irregular intervals to provide some security from detection and subsequent jamming by the enemy.

12. Reporting Information

Ground radar surveillance reporting procedures should be incorporated in the unit SOP. Depending upon the specific requirements, positive and negative information obtained by the radar will be reported by the operator immediately or at prescribed intervals. The operator will transmit the information by using coordinates, distance from a known reference point, or range and azimuth of the activity located and will state what he determines the target to be, i.e., dismounted personnel, wheeled or tracked vehicles, etc. The specific reporting details will be prescribed by

the commander when assigning the surveillance mission to the radar team. The requirement for immediate reporting of enemy activity must be stressed at all echelons.

13. Alternate and Supplementary Positions

Alternate and supplementary positions are selected and prepared as time permits. When the mission cannot be accomplished from the primary position, the senior radar operator may displace the equipment to an alternate position. Prior to movement to such positions, the section sergeant is notified. Movement to supplementary positions is accomplished only on order of the section sergeant or unit commander.

Section III. THE OFFENSE

14. General

Radar teams may be profitably employed in a penetration, envelopment, or infiltration. In a penetration, they may locate enemy defenses to the extent that the attacking commander may avoid enemy strengths and capitalize on enemy defensive weaknesses discovered by radar and other surveillance means. Gaps between enemy units may be detected to facilitate infiltration and assailable flanks may be located to facilitate the envelopment.

15. Infiltration

a. When gaps in enemy defenses have been located, the attacking force may infiltrate through the enemy position. Radar teams may be profitably employed in conjunction with infiltration by surveying infiltration lanes for enemy activity and/or to determine the progress of infiltrating units. When radio silence is necessary, radar may be used to determine time of passage through phase lines and/or checkpoints.

b. Short-range radar teams may be employed with infiltrating units in the enemy rear area. Use of a team by an infiltrating force may enable a unit to locate enemy activity and avoid discovery. Conversely, radar emissions may, in certain circumstances, compromise the location of friendly units. The determination of whether radar teams should be employed by an infiltrating force will generally depend upon the urgency of obtaining information of the enemy in the area as opposed to the need for avoiding discovery. If radar is employed with infiltrating units, it may also be used to facilitate link-up with attacking forces.

16. Movement to Contact

During the movement to contact, radar teams may be employed with security elements on an exposed flank or provide additional

observation and security. Since radar sets cannot be operated during movement, it may become necessary to employ teams in pairs and move them by bounds to provide continuous surveillance.

17. Conduct of the Attack

a. Once contact has been established, radar teams may be employed to provide surveillance forward of the line of contact or on an exposed flank. Teams may be positioned to provide surveillance over critical areas or avenues of approach into the zone of attack of the company. Radar teams may locate enemy activity to facilitate use of preparatory fires and may survey enemy positions to establish whether any reinforcement, shifting, or withdrawal of enemy units is effected after the attack has begun. Radar may be used to determine the result of effects after nuclear fires.

b. During darkness or poor visibility, radar teams may be employed as a means of vectoring or guiding friendly attacking elements. They may be utilized in tracing the movement of forward friendly units in order to establish and/or confirm their specific location at any given time and to coordinate supporting fires with the advance of friendly elements. To facilitate location of friendly elements, a pattern of signals may be established to assist the operator in identification. This may consist of swinging a canteen or helmet in rotary fashion, using a corner reflector (which is issued with the set), or using any pattern of movement which can readily be identified by the operator of the radar equipment. When other means of communications fail and pyrotechnics are not visible, coded signals may be sent to radar teams to request lifting or shifting of supporting fires.

18. Displacement

a. Radars will be kept as far forward as the tactical situation and terrain will permit. Teams displace to support a continuation of the attack or when they can no longer provide effective support for a unit making the attack. Displacement may also be required to support the consolidation on the objective. For this reason, displacement should not be arbitrarily delayed until the teams can no longer provide effective support. The commander must weigh the immediate loss of a surveillance capability against the requirement for immediate surveillance during the consolidation.

b. When intermediate objectives have been assigned, it may be desirable to displace teams to the objective immediately after it is seized. When a closely coordinated attack is to be made from an intermediate objective against a strong enemy position, plans must be made for early displacement to the intermediate objective.

c. Displacement should be accomplished so teams are in position

on the objective immediately following its seizure. Timely displacement will enable forward units to continue destructive fire on withdrawing enemy units or to detect enemy activity indicating a counterattack. Whenever feasible, teams displace by bounds so that some radar surveillance means are available at any given time.

19. Consolidation and Reorganization

Radar teams displace on order to positions previously selected by a visual or map reconnaissance. During the consolidation and reorganization, primary emphasis is given to immediate placing of the equipment in operation to obtain information of the enemy. Thereafter, positions are improved and equipment is dug in and camouflaged as the situation permits. Since the radar teams on the objective will be surveying the area beyond the objective, they must be fully informed of friendly patrols and other elements sent forward to maintain contact with the enemy.

20. Pursuit of Exploitation

a. In the pursuit or exploitation, radar teams are employed essentially as in the movement to contact. They may be employed with security elements to provide surveillance on an exposed flank or may otherwise provide observation and security for the company. Radar teams may be moved by bounds with rapidly advancing elements to provide information of enemy activity. By detecting the presence or lack of enemy activity in an area, the ground surveillance may appreciably speed up pursuit operations.

b. When pursuing forces are lifted by fixed- or rotary-wing aircraft to seize key objectives which block enemy routes of withdrawal, radar teams may be attached to such forces. Because of its lightweight equipment, the short-range teams are ideal for this mission.

c. Radar teams attached to an enveloping force may be sited to locate withdrawing enemy elements and thereby facilitate their destruction. Radar may also be used in identification of friendly units to facilitate the linkup with friendly elements.

21. River Crossing Operations

Radars are used in a river crossing as in normal offensive operations. Radars placed on dominating terrain on the near bank may determine the extent of progress of friendly units on the far bank. When smoke is used by friendly forces engaged in a river crossing, radar may be used to detect enemy troop activity on the far bank including withdrawal, reinforcement or shifting of troop units on the far bank.

Section IV. DEFENSE

22. General

In the defense, the radars are employed to maintain surveillance over avenues of approach, possible enemy attack positions, and assembly areas. The surveillance effort is not only directed forward of the FEBA, but also in depth throughout the battle area. Particular attention is given to gaps between units, exposed flanks, possible helicopter or parachute landing zones within the battle area, and other critical areas. To this end, alternate and supplementary positions for radar teams are established to provide complete surveillance coverage of the battle area.

23. Employment in the Defense

a. Radar teams may support one or any combination of the three echelons of defense. Teams may be employed with the security forces (GOP, COP, etc.) to extend its surveillance capability. Teams employed with the security force normally revert to their primary mission when the security force is withdrawn.

b. The uses of radar in the defense are limited only by the capabilities of the equipment and the imagination and ingenuity of the tactical commander. Radar teams may be employed in conjunction with barrages and final protective fires by determining when the enemy is located in these areas. Radars may be used in conjunction with emplaced Claymore antipersonnel weapons in determining when such weapons can best be detonated. They may be used to determine the optimum time for detonation of explosives, chemicals, or atomic demolition munitions.

c. Since the enemy may often attack at night, during poor visibility, or with use of heavy smoke screens, radar will be of great use in defensive operations. When an enemy attack is made on a broad front, the amount of enemy activity in a given area may indicate the possible location of the enemy main effort. When radar sightings are used in conjunction with knowledge of enemy tactics, specific enemy maneuvers may be anticipated. Radar sightings may be used to establish the depth of the enemy offensive effort and to indicate whether a feint or demonstration is being conducted in the area.

24. Patrols

a. Plans for the employment of radar are closely coordinated with patrol plans to enable the radar operators to distinguish between movement of friendly elements and enemy infiltration of personnel or vehicles. To assist in this identification, a set of signals (swinging a canteen or helmet, use of corner reflectors, etc.) may be established for the specific action. Patrols may also send messages to the radar team by use of a corner reflector.

b. When a radar team is used in surveillance of an area in which friendly patrols are operating, the radars may locate enemy activity (e.g., an ambush) which may be detrimental to the friendly patrol. In such a case, a radio message to the patrol or use of pyrotechnics may direct the patrol to avoid the discovered enemy activity. In other circumstances, friendly patrols may be vectored toward enemy activity discovered by radar equipment. Again, use of radio messages or pyrotechnic signals may guide the patrol toward the enemy activity in the area.

25. Ambushes

Radar teams may locate enemy patrols moving toward friendly defensive positions and thereby allow friendly units to ambush such patrols and take prisoners.

26. Action During a Counterattack

During a counterattack, radar teams will continue to report information of enemy activity. By prior arrangement, radar teams located to the rear may also be used to establish the precise location of friendly units on the periphery of an enemy penetration. This identification and location of units may be a critical element in the counterattack, particularly when nuclear fires are to be employed. In the counterattack, radars may be used to gain information for the commander of the strength and depth of the enemy penetration. Teams employed with forward companies in or adjacent to an enemy penetration may shift their area of surveillance on order to the area of penetration to provide the commander with this information.

Section V. RETROGRADE OPERATIONS

27. General

a. In retrograde operations, the radar section can provide significant information of the enemy which may enable a commander to decide upon the best method of withdrawal and the time to initiate the retrograde action.

b. By use of ground surveillance radar, the commander may obtain additional information of the enemy strength in the area. Based upon this information and information obtained from other sources, he may determine whether close combat may be risked in daylight in order to allow a later withdrawal at night.

28. Movement to Subsequent Positions

a. The decision as to when to displace radar equipment involves a consideration of many factors. In most retrograde operations,

secrecy will be a primary consideration. Since radar emissions may be detected by the enemy, any premature withdrawal of radar equipment from the present position may compromise this secrecy. The commander must also consider the amount of time required to take the equipment out of action. Under normal circumstances this will require approximately 5 minutes for the AN/PPS-4.

b. With these and other considerations, the commander must weigh the requirement for maintaining surveillance equipment on position as long as practicable. Radars may aid in the timely withdrawal of a unit by detecting the enemy advance and allowing friendly units to withdraw without becoming decisively engaged. Premature withdrawal of radar teams should therefore be avoided. Because of the weight of the equipment, motor transportation should be used to facilitate a rapid withdrawal.

c. During the course of movement to the rear, the enemy may interdict road nets along the routes of withdrawal. To counter this, radar teams may be employed with security element to over-watch movement of friendly units to the rear. Radar may also be employed with the rear guard to assist in maintaining contact with the enemy and to determine the extent of aggressiveness of the enemy pursuit.

29. Use With Stay-Behind Forces

During a retrograde movement, friendly units may be ordered to let enemy elements bypass them in order to operate in the role of stay-behind forces. When the terrain and situation dictate, radar teams may be employed with such forces to assist in locating nuclear targets and/or detecting enemy activity. Later withdrawal may be accomplished by ground or air movement.

APPENDIX V

EMPLOYMENT OF ARMORED PERSONNEL CARRIERS IN HASTY RIVER CROSSING OPERATIONS

Section I. GENERAL

1. Purpose

This appendix is a guide for commanders in the use of the APC in a hasty river crossing operation. It includes the technical information necessary for the vehicle's safe employment in such crossings. To insure clarity and understanding, the following definitions are provided for certain terms which are peculiar to water operation and are used within this appendix.

a. *Stream Velocity*. Rate of flow of the current of the stream, in kilometers per hour.

b. *Freeboard*. The distance from the waterline to the deck when the vehicle is in the water.

2. Precrossing Considerations

Upon reaching a water obstacle, the unit commander, in order to minimize delay, follows a definite sequence or checklist prior to employing his armored personnel carriers. This sequence is—

a. Determine the velocity of the stream and its characteristics.

b. Determine bank conditions at the entrance to the stream to include underwater obstacles.

c. Select landing points on the far shore and determine bank conditions at these points.

d. Insure that the APC are properly checked prior to entering the water and upon leaving the water.

3. Stream Velocity

The maximum stream velocity in which the APC can be safely operated depends on such factors as the choppiness of the water, the amount of debris or ice in the water, and the maximum acceptable downstream drift distance. When the rate of flow approaches the maximum allowable stream velocity, (6.6 KMPH for the M113 and 9.6 KMPH for the M59), particular attention must be given to drift distance, balance of load, entry into the water, and ability of drivers. A simple way to determine the stream velocity is to use a floating device over a measured distance. Measure a distance of at least 100 meters along the near riverbank. Designate the upstream end as point A and the downstream end as point B. At point A, throw into the stream any object that will float, such as a

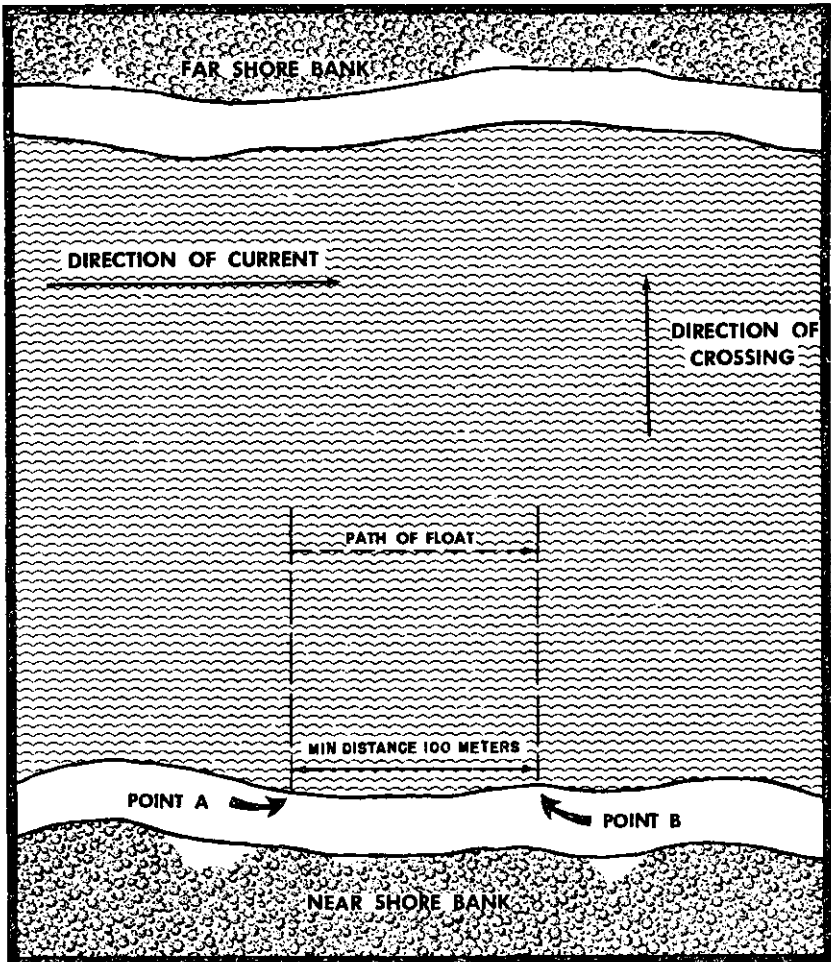

Figure 38. Float timing device over a measured distance.

piece of wood or cork. Using a stopwatch or the second hand of a regular watch, determine the time it takes the floating object to move from point A to point B (fig. 38). For example, if it takes 20 seconds for the object to float 100 meters, the rate of flow of the stream is 5 meters-per-second. This figure in meters-per-second must then be converted to kilometers-per-hour. This is accomplished by using the conversion table shown in figure 39. From the proper number under the meters-per-second column, read horizontally left to the kilometers-per-hour column. This is the stream velocity. At least two tests should be made with floating objects, the average time being used to determine the rate of flow in meters per second. The tests should be made in the fastest water that may be crossed by the carriers.

KMPH		MPS
1.6	—	0.4
3.2	—	0.8
4.8	—	1.3
6.4	—	1.7
8	—	2.2
9.6	—	2.6
11.3	—	3.1
12.9	—	3.5
14.5	—	4
16	—	4.4
17.7	—	4.9
19.3	—	5.3
20.9	—	5.8
22.6	—	6.2
24.2	—	6.7
25.8	—	7.1
27.4	—	7.6
28.9	—	8
30.6	—	8.5
32.2	—	8.9
33.8	—	9.3
35.4	—	9.8
37.1	—	10.3
38.6	—	10.7
40.3	—	11.1
41.9	—	11.6
43.5	—	12.1
45.1	—	12.5
46.7	—	13
48.3	—	13.4

Figure 39. Table for converting meters per second to kilometers-per-hour.

4. Stream Characteristics

a. *Changes in Velocity.* A sluggish stream or river may become a torrent in a few hours or even minutes as a result of sudden heavy rainfall. This is more likely to happen in tropical and arid regions, but can occur anywhere. Stream velocities must be checked at frequent intervals to provide warning of such changes.

b. *Channels.* Velocities may vary in different parts of a stream. The rate of flow is usually slowest near the shore and fastest in the main channel. Drivers and commanders of APC must be alert when moving into a channel from quiet water, to keep the APC from going out of control and being swept downstream.

c. *Debris.* Fast-moving streams often carry large quantities of logs, brush, and other debris. In cold climates, chunks of ice may be floating in a stream. Debris is a serious hazard to the APC; a single piece can foul a track and put the APC out of control.

d. *Stream Bottom.* Stream bottoms often contain hidden sandbars or other obstacles that could cause damage to a track or to the APC itself through loss of control. Whenever possible the company commander should request engineer assistance to determine the condition of the stream bottom in his crossing zone and such obstacles should be marked by buoys.

5. Bank Conditions

Poor banks can often be improved by use of pioneer tools or dozers. Corduroying (laying logs) can be employed to improve entrances into the water. Steel tracks provide better traction than do rubber track pads. Since infantry units have no organic boats, it is seldom possible to do anything about banks on the far side of the stream except to use binoculars to select the best available exits.

6. Slope of Entrances and Exits

a. Gently sloping entrances and exits are desirable. However, even on the most gradual slopes, the APC must enter the water slowly (approximately 3 kilometers-per-hour) in order to avoid a large wave. When descending steep banks, the vehicle will tend to dive unless the approach is slow enough to allow the front to float.

b. The most common way to express slope is in percent (fig. 40). Thus, a 1-percent slope rises or descends one unit in a horizontal distance of 100 units; a 10-percent slope rises or descends 10 feet in 100 feet, or 10 meters in 100 meters, etc. The formula for percent slope is—

$$\frac{\text{VERTICAL DISTANCE}}{\text{HORIZONTAL DISTANCE}} \times 100 = \text{SLOPE IN PERCENT}$$

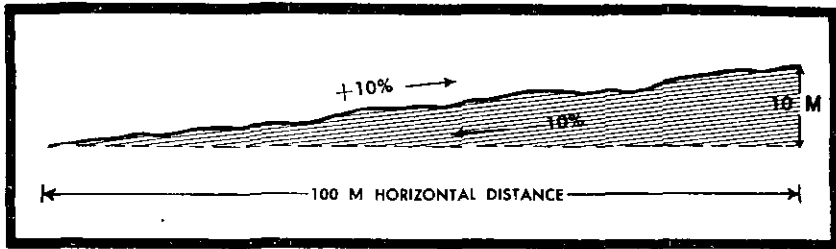

Figure 40. Expression of percent slope.

7. Determining Landing Point on Far Shore

a. The front of the APC is always pointed directly across the stream, perpendicular to the river current. The driver must not buck the current. The only time this rule does not hold true is when the speed of the APC, in water, is twice the speed of the current. Then, the front of the APC may be pointed into the current; an angle of not more than 30° in the direction of the flow is acceptable. When the speed of the current and the speed of the APC are the same, the APC drifts one meter downstream for each meter it moves forward. When the speed of the current is twice that of the APC, the carrier moves two meters downstream for each meter it moves forward.

b. A simple formula for determining the point of landing on the far shore is:

$$\frac{\text{STREAM VELOCITY}}{\text{SPEED OF APC (KMPH)}} \times \frac{\text{DISTANCE ACROSS THE STREAM IN METERS}}{\text{DISTANCE OF DOWNSTREAM DRIFT IN METERS}} =$$

For example, an APC traveling at 4 kilometers-per-hour in a stream that has a velocity of 4 kilometers-per-hour and is 100 meters across will land 100 meters downstream from the point where it entered the water (fig. 41).

8. Determining Formation and Priority of Crossing

a. The most important factors in determining the formation and priority for stream crossings are the mission, the number of entrances and exits, and the number of APC to cross. For example, if the mission requires a mechanized infantry unit to cross in one move, and there are sufficient entrances and exits, the best formation is an echelon—echelon left if the stream flows left to right, echelon right if the stream flows right to left. The APC farthest downstream moves out first, followed by the one next farthest downstream, and so on; the APC farthest upstream moves out last. Use of this formation insures that upstream vehicles do not drift into vehicles downstream.

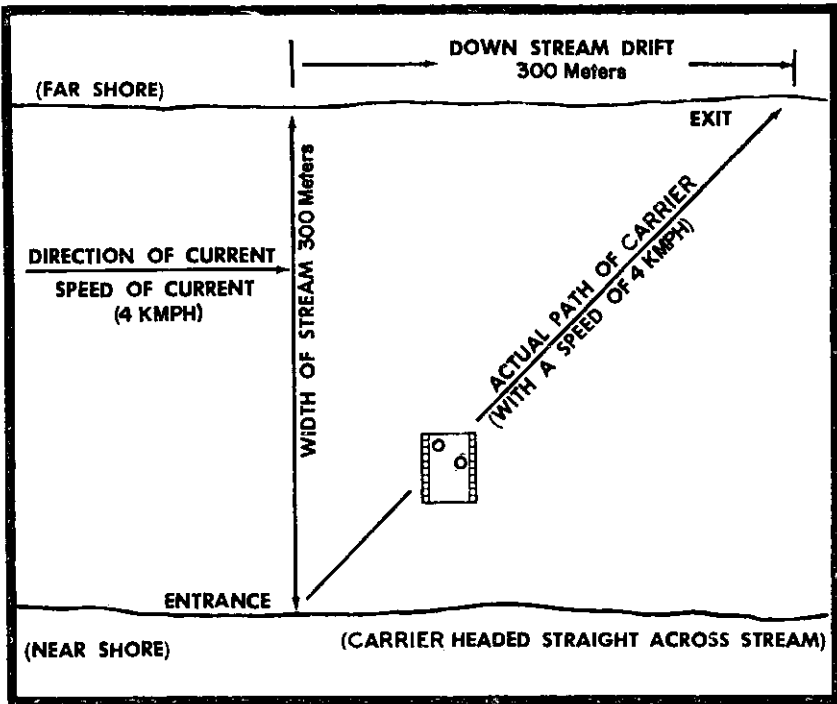

Figure 41. Downstream drift in a stream crossing.

b. If the mission is one of ferrying, the greatest danger is that of collision. A collision may occur in one of two situations—the meeting situation, and the passing situation.

- (1) When two APC approach each other head on, each should turn to the right and pass each other on their respective left sides. The turn should be started soon enough to allow each driver to recognize the intentions of the other and to compensate for changing drift factors.
- (2) Passing a slower vehicle on either side can be accomplished, provided due allowance is made for drift and there is ample space, both laterally and in depth. (Note that per unit of distance in the forward direction, the slower vehicle will have a greater amount of drift than the overtaking vehicle.) The passing vehicle should begin its turning movement early, cross the wake of the overtaken vehicle at an angle of 45° , and pass well to the side. If there is a danger of collision, based on the factors discussed above, the faster vehicle should not attempt to pass. In any event the vehicle being overtaken has the right of way.

Section II. ARMORED PERSONNEL CARRIER CHECKLISTS

9. General

Each infantry commander must insure that his unit has an SOP for utilization of its APC in water operations. This SOP should include checklists covering actions to be taken at various stages of such operations.

10. Check Prior to Entering the Water

- a.* Check the drain plugs.
- b.* Raise and lock the end ramp.
- c.* Start and operate the bilge pump. If necessary, take on water (about 100 gallons) to permit a check of the operation of the pump.
- d.* Extend the trim vane which is located on the top front of the APC. This trim vane serves only to trim the vehicle; it has no appreciable effect upon handling of the vehicle in the water.
- e.* Close and secure all hatches and doors.
- f.* Check for proper load distribution. All cargo must be secure so it will not shift.
- g.* The commander's cupola may be kept open except in rough water (depending on the tactical situation).

11. Check While Afloat

- a.* The hand throttle is used in order to prevent the possibility of sudden deceleration if the driver's foot should slip from the accelerator. Sudden deceleration may cause the vehicle to pitch forward, submerging the bow.
- b.* All turns in the water are made the same as on land.
- c.* Freeboard is checked continually.

12. Check Upon Leaving the Water

- a.* Approach the land squarely.
- b.* Approach the land at reduced speed (approximately 3 kilometers-per-hour).
- c.* When out of the water, retract the trim vane.
- d.* Continue to operate the bilge pump after leaving the water until all the water is pumped out.

Section III. PERSONNEL SAFETY

13. Life Preservers

It is difficult to evacuate the APC while wearing a kapok vest-type life preserver. Whenever available, the inflatable belt-type

life preserver should be worn. This is especially true for the driver and vehicle commander, since it is especially difficult to exit through the cupola when wearing a kapok preserver. When only the kapok vest-type preserver is available, it should be slung over one shoulder until the hatch is cleared.

14. Discharging Passengers

If the APC cannot climb out of the stream on the far bank, it should be backed up to the bank, the ramp lowered, and personnel discharged.

APPENDIX VI

STANDARD PROCEDURES FOR PROTECTION AGAINST TOXIC CHEMICAL ATTACK

1. Procedures

The following is a relatively simple and standard set of procedures which will be effective against toxic chemical attack under almost all circumstances. These procedures are to be followed when CBR attack is imminent, and after CBR operations have been initiated.

WHEN THE ENEMY ATTACKS YOUR POSITION WITH THE FOLLOWING:

SHELLS
SMOKE

BOMBS
SPRAY

YOU WILL TAKE THE FOLLOWING ACTIONS *WITHOUT FURTHER COMMAND*:

- a. *STOP BREATHING.*
- b. TAKE COVER (USE PONCHO TO PROTECT AGAINST AIRCRAFT SPRAY).
- c. *IF LIQUID FALLS IN EYES, FLUSH EYES AND FACE WITH WATER FROM CANTEEN BEFORE MASKING.*
- d. *MASK RAPIDLY.*
- e. REMOVE LIQUID FROM SKIN.
- f. FLUSH SKIN WITH WATER FROM CANTEEN.
- g. APPLY M5 PROTECTIVE OINTMENT TO CONTAMINATED SKIN.
- h. DECONTAMINATE OR REMOVE CONTAMINATED PORTIONS OF CLOTHING.
- i. USE ATROPINE INJECTION *ONLY* IF NERVE-AGENT SYMPTOMS APPEAR (MAXIMUM OF THREE INJECTIONS BY *NON-MEDICAL PERSONNEL*).
- j. ATTACH USED ATROPINE INJECTION SYRETTE(S) TO BREAST POCKET LAPEL BY PIERCING LAPEL WITH NEEDLE AND BENDING NEEDLE INTO HOOK.
- k. *REMAIN MASKED* UNTIL AREA HAS BEEN CHECKED WITH DETECTION DEVICES AND "ALL CLEAR" IS ORDERED BY UNIT COMMANDER.
- l. *CONTINUE MISSION.*

2. Reports

Report of enemy use of CBR agents will follow the format of DA Form 890.

INDEX

	Paragraphs	Page
Advance guard.....	232, 234, 239	217, 220, 224
Advance guard support.....	233	219
Advance party.....	233	219
Aid post.....	44, 139	41, 148
Air attack, actions against.....	13	14
Airborne assault:		
Conduct of:		
Assembly and reorganization.....	203	196
Attack.....	204, 205	197
Landing.....	202	196
Marshaling.....	200	194
Subsequent operations.....	206	198
Employment of the company.....	190	185
Orders.....	192	187
Organization for combat.....	9	188
Planning:		
Air movement plan.....	198	194
Ground tactical plan.....	196	189
Landing plan.....	197	193
Marshaling plan.....	199	194
Preparation.....	191	186
Reconnaissance.....	193	188
Responsibility during air movement.....	201	196
Airborne operations:		
Definitions.....	184	183
Echelonment.....	187	184
Employment of companies.....	183	183
Phases of supply.....	39	39
Planning sequence.....	186	184
Rehearsals.....	188	185
Air control point.....	213	205
Airmobile operations:		
Command relationship.....	209	199
Conduct of:		
Air movement.....	217	208
Assault.....	218	209
Defense.....	219	210
Landing.....	218	209
Marshaling.....	216	208
Employment of the company.....	208	198
Planning:		
Air movement plan.....	213	205
Ground tactical plan.....	211	199
Landing plan.....	212	205
Marshaling plan.....	214	207
Ammunition.....	37, 66	37, 66
Antiguerrilla operations.....	110-112	116
Antitank section:		
Defense.....	129, 138	134, 145
Night attack.....	98	101
Offense.....	50, 61, 66	46, 61, 66

	Paragraphs	Page
Antitank section—Continued		
Organization.....	6	5
Personnel, duties.....	9	12
River crossings.....	103, 104	105, 108
Armored personnel carriers, employment:		
Communication.....	22	25
Defense.....	130	136
Offense.....	75-87	77
Retrograde operations.....	171, 175, 180	172, 176, 181
River crossings.....	103, app V	105, 250
Armorer, duties.....	7	7
Assault.....	65, 85, 100	63, 87, 102
Assembly area.....	63, 93	62, 95
Attached weapons, use:		
Defense.....	129	134
Offense.....	61, 70, 98	61, 72, 101
Attack:		
Conduct of:		
Assault.....	65	63
Assembly area to LD.....	63	62
Continuation of the attack.....	69	71
Employment of company reserve.....	67	70
Employment of weapons platoon.....	66	66
LD to assault line.....	64	62
Mechanized.....	85-87	87
Reorganization and consolidation.....	68	71
Employment of attached tanks:		
Dismounted infantry and tanks.....	71	72
Infantry riding tanks.....	73	77
Mechanized infantry and tanks.....	79	80
Reorganization and consolidation.....	74	77
Tanks support by fire.....	72	74
Planning for:		
Company formations.....	55	55
Continuation of the attack.....	59	58
Control measures.....	54, 78	51, 78
Fire support.....	60	59
General.....	52	50
Mechanized.....	78-84	78
Reorganization and consolidation.....	58	58
Security.....	57	57
Scheme of maneuver.....	53	50
Use of company reserve.....	56	56
Utilization of organic and attached weapons.....	61	61
Preparation for:		
Actions of company commander.....	50	46
Actions of rifle platoon leader.....	50	46
Actions of weapons platoon leader.....	50	46
The company.....	51	49
Attack formations.....	55, 81, 94	58, 86, 97,
	104	108
Attack position.....	54	51
Avenues of approach.....	18	20
Awards and decorations.....	30	31

	Paragraphs	Page
Axis of advance.....	54, 78	51, 78
Barrages.....	132	137
Barriers.....	118	121
Battle area.....	119, 126	122, 129
Blocking position.....	119	122
BMNT.....	17	20
Boundaries.....	126	129
CBR operations.....	11, app VI	14, 258
Checkpoints.....	54	51
Classes of supply.....	34-37	36
Combat outpost.....	122	124
Command post.....	139	148
Communication:		
Type radio nets and wire systems.....	23	28
Use.....	22	25
Communication chief, duties.....	7	7
Company aid post.....	44, 139	41, 148
Company clerk, duties.....	7	7
Company commander, duties.....	7	7
Company trains.....	33	35
Concealment and cover.....	18	20
Concentrations.....	132	137
Consolidation.....	58, 68	58, 71
Contact points.....	54	51
Control, during movement.....	230	217
Control measures:		
Assault coordination line.....	54, 64, 65, 78	51, 62, 63, 78
Attack position.....	54, 63, 78, 93, 104	51, 62, 78, 95, 108
Axis of advance.....	54, 78	51, 78
Checkpoints.....	54	51
Direction of attack.....	54	51
Infiltration line.....	115	119
Line of departure.....	54, 63, 64, 93	51, 62, 95
Mechanized attack.....	78	78
Objectives.....	54, 93	51, 95
Phase line.....	54, 78, 93	51, 78, 95
Probable line of deployment.....	93	95
Release points.....	93	95
Time of attack.....	54	51
Zone of action.....	54, 78, 93	51, 78, 95
Coordinating points.....	126	129
Corridors.....	18	20
Counterattack plan.....	134	141
Counterintelligence.....	20	23
Cross compartment.....	18	20
Defense:		
Conduct of:		
Counterattack.....	143	151
Daylight.....	141	148
Night.....	142	150
Definitions.....	119	122
Fundamentals.....	118	121

	Paragraphs	Page
Defense—Continued		
Missions.....	117	121
Organizing the defense:		
Command and administrative installations.....	139	148
Forward platoon defense area.....	136	143
Priority of tasks.....	135	142
Reserve rifle platoon.....	137	143
Weapons platoon.....	138	145
Perimeter defense.....	144, 146	152, 153
Planning for:		
Barrier plan.....	133	140
Communications.....	131	137
Counterattack plan.....	134	141
Employment of organic and attached weapons.....	129	134
Employment of the rifle platoon.....	128	131
Fire planning.....	132	137
Surveillance and security.....	127	130
Utilization of armored personnel carriers.....	130	136
Reverse slope.....	147-149	154
Riverline.....	150-152	157
Security.....	118, 123, 124	121, 127
Security forces.....	120-122	123
Delaying actions:		
Conduct.....	181	181
Organization of positions.....	179	179
Terrain characteristics.....	178	179
Utilization of armored personnel carriers.....	180	181
Detachments left in contact.....	170	171
Direct support.....	129	134
Direction of attack.....	54	51
Discipline, law and order.....	30	31
Dismount area.....	78	78
Drop zone.....	197	193
Duties, company personnel.....	7, 8, 9	7, 11, 12
EENT.....	17	20
Enemy information.....	19	22
Estimate of the situation.....	14	15
Executive officer, duties.....	7	7
FEBA.....	119	122
Final coordination line.....	54, 64, 65, 78	51, 62, 63, 71
Fire direction center.....	66	66
Fire direction computers, duties.....	9	12
Fire support planning.....	60, 84, 107, 132, 148,	59, 87, 113, 137, 155, 150, 196, 211
Fire support:		
Attachment.....	129	134
Direct support.....	129	134
General support.....	129	134
Fire team leader, duties.....	8	11
First sergeant, duties.....	7	7
Flank guard.....	236, 240	222, 226
Flight corridor.....	231	205

	Paragraphs	Page
Flight route.....	231	205
Formations, attack.....	55	55
Formations, tactical.....	228	216
Forward observers.....	9, 60, 138	12, 59, 145
General outpost.....	121	124
General support.....	129	134
Graves registration.....	30	31
Ground surveillance section:		
Employment.....	App IV	237
Personnel, duties.....	7	7
Infiltration.....	114-116	118
Intelligence:		
Counterintelligence.....	20	23
Enemy information.....	19	22
Terrain.....	18	20
Weather.....	17	20
Joint airborne operations.....	189-206	185
Key terrain.....	18	20
Landing zone.....	212	205
Leadership and command.....	2	3
Line of departure.....	54	51
Linkup.....	196, 211	189, 199
Main body.....	235	222
Maintenance procedures.....	45	42
Maintenance section.....	7	7
Marshaling.....	200, 216	194, 208
Mechanized attack.....	75-87	77
Mechanized rifle company:		
Attack.....	75-87	77
Defense.....	130	136
River crossings.....	103	105
Tactical movements.....	239-242	224
Medical service.....	44	41
METT.....	14	15
Mission, rifle company.....	3, 47, 117	4, 46, 121
Mission, weapons platoon.....	47	46
Miscellaneous logistical activities.....	44-46	41
Morale.....	30	31
Mortar section:		
Defense.....	129	134
Forward observers.....	9, 66	12, 66
Night attack.....	98	101
Offense:		
Displacement.....	66	66
Employment.....	50, 61	46, 61
FDC.....	66	66
Firing positions.....	66	66
Targets.....	66	66
Personnel, duties.....	9	12
River crossings.....	103, 104	105, 108
Mutual support.....	118	121

	Paragraphs	Page
Night attack:		
Characteristics.....	90	93
Conduct of attack.....	100	102
Control measures.....	93	95
Formations.....	94	97
Illumination.....	96	100
Purpose.....	90	93
Reconnaissance.....	91	94
Reorganization and consolidation.....	99	102
Security.....	95	98
Supporting fires.....	97	100
Techniques.....	90	93
Use of organic weapons and attachments.....	98	101
Night movement.....	231	217
Objective area.....	196, 211	189, 199
Objectives.....	54	51
Observation and fire.....	18	20
Observation post.....	138, 139	145, 148
Obstacles.....	18	20
Offense, concept.....	49	46
Operation order.....	App III	234
Organization for combat.....	15	17
Patrolling.....	19, 144-146	22, 152
Personnel responsibilities, company:		
Awards and decorations.....	30	31
Civilian personnel.....	30	31
Discipline, law and order.....	30	31
Graves registration.....	30	31
Headquarters management.....	30	31
Morale.....	30	31
Personnel procedures.....	30	31
Personnel services.....	30	31
Prisoners of war.....	30	31
Replacements.....	30	31
Strengths, records and reports.....	30	31
Phase lines.....	54	51
Platoon leader, duties.....	8	11
Platoon personnel, duties.....	8	11
Platoon sergeant, duties.....	8	11
Point.....	233	219
Prisoners of war.....	19, 30	22, 31
Pursuit.....	87	91
Radar.....	App IV	237
Radio nets.....	23	28
Radiotelephone operators.....	7, 8, 9	7, 11, 12
Raids:		
Airborne.....	107	113
Conduct.....	108	115
Fire support.....	107	113
Organization.....	107	113
Planning.....	107	113
Rallying points.....	107	113

	Paragraphs	Page
Rehearsals.....	107	113
Routes.....	107	113
Rallying points.....	107	113
Rear guard.....	237	224
Relief in place:		
Command.....	160	164
Conduct.....	159	163
Planning.....	158	162
Replacements.....	30	31
Reorganization.....	58, 68	58, 71
Reserve platoon:		
Defense.....	128, 137	131, 143
Offense.....	56, 56	56, 70
Reserve rifle company:		
Defense:		
Conduct.....	156	161
Counterattack planning.....	155	160
Missions and employment.....	153	159
Organization of positions.....	154	160
Offense.....	88-89	98
Retirement.....	166	162
Retrograde operations:		
Basic considerations.....	164	165
Daylight withdrawal.....	173-176	174
Delaying actions.....	177-181	179
Night withdrawal.....	168-172	170
Purpose.....	162	165
Retirement.....	166	168
Types.....	163	165
Stay behind forces.....	167	168
Reverse slope defense.....	147-149	154
Rifle company:		
Capabilities.....	4	4
Characteristics.....	5	5
Mission.....	3	4
Organization.....	6	5
Tactical employment.....	10, 48	13, 46
Rifle squad leader, duties.....	8	11
River crossings:		
Concept.....	102	105
Types.....	101	104
Use of APC.....	103	105
Use of boats.....	104, 105	108, 112
Riverline defense.....	150-152	157
Security:		
Attack.....	57, 83, 95,	57, 86, 98,
	107	113
Assembly areas.....	123	127
Defense.....	118	121
During movement.....	229	216
Measures.....	12	14
Rear installations.....	124	127
Scheme of maneuver.....	53	50
Security missions.....	227	216

	Paragraphs	Page
Stay behind forces.....	167	168
Supply:		
Airborne:		
Phases of supply.....	39-42	39
Resupply in the objective area.....	43	40
Classes of:		
Ammunition.....	37	37
Clothing and equipment.....	35	36
Food and water.....	34	36
Fuel and lubricants.....	36	37
Miscellaneous services.....	46	44
Supply sergeant, duties.....	7	7
Tactical movements:		
Airmobile detachments.....	243	227
Control.....	230	217
Foot marches.....	232-237	217
Formations.....	228	216
Mechanized or motorized.....	239-242	224
Missions.....	227	216
Night movement.....	231	217
Security.....	229	216
Tanks, employment of.....	70-74	72
Task force.....	15	17
Terrain.....	18	20
Troop leading procedures.....	App II	231
Weapons platoon:		
Ammunition resupply.....	37, 66	37, 66
Attack.....	50, 61, 66,	46, 61, 66,
	98	101
Defense.....	138	145
Mission.....	47, 138	46, 145
Organization.....	6	5
Personnel, duties.....	9	12
Weapons platoon leader, duties.....	9	12
Weapons squad leader, duties.....	8	11
Weather.....	17	20
Wire entanglements:		
Protective.....	133	140
Supplementary.....	133	140
Tactical.....	133	140
Wiremen, duties.....	7	7
Wire systems.....	23	28
Withdrawal:		
By air:		
Concept.....	221	211
Conduct.....	225	212
Organization.....	224	212
Planning.....	222	211
Reconnaissance.....	223	212
Daylight:		
Conduct.....	176	177
Planning.....	174	175
Utilization of APC.....	175	176

	Paragraphs	Page
Night:		
Conduct	172	173
Detachments left in contact	170	171
Planning	169	170
Utilization of APC	171	172
Types	165	167
Zone of action	54	51

BY ORDER OF THE SECRETARY OF THE ARMY:

G. H. DECKER,
General, United States Army,
Chief of Staff.

Official:

J. C. LAMBERT,
Major General, United States Army,
The Adjutant General.

Distribution:

Active Army:

DCSPER (2)	Div Co/Btry/Trp (1) except
ACSI (2)	Inf Co (5)
DCSOPS (2)	Instl (5)
DCSLOG (2)	Tng Comd (25) except
ACSRC (2)	USA Ord Tng Comd (1800)
CRD (1)	USMA (5)
COA (1)	USACGSC (50)
CINFO (1)	Br Svc Sch (5) except
TIG (1)	USAIS (3577)
TJAG (1)	USAARMS (1250)
TPMG (1)	USAAMS (1100)
USACHBD (3)	USATSCH (235)
USA Maint Bd (2)	US ARADSCH (10)
Tech Stf, DA (1)	USAAVNS (10)
USCONARC (20)	USASCS (10)
ARADCOM (2)	USAES (15)
ARADCOM Rgn (1)	USACMLCSCH (10)
OS Maj Comd (10)	PMGS (50)
LOGCOMD (1)	USACHS (150)
Armies (25)	FSUSA (100)
MDW (25)	MFSS (15)
Corps (15)	USAINTC (8)
Div (10)	PMS Sr Div Units (1)
Div Arty (1)	PMS Mil Sch Div Units (1)
Div Support Comd (2)	CDEC (5)
Combat Arm Bde (5)	MAAG (5)
Regt (5)	Mil Msn (5)
Div Bn/Sqd (2) except	
Inf Bn (5)	

NG: Div, Div Arty, Div Trains, Bde, BG, Combat Comd, Regt, Gp, Bn, Co, Btry, Trp (3).

USAR: Same as Active Army except allowance is one copy to each unit.

For explanation of abbreviations used, see AR 320-50.