

• ILLUSTRATED CATALOGUE •

—OF—

ELECTRICAL APPLIANCES

—FOR—

**ARC AND INCANDESCENT
ELECTRIC LIGHTING.**

E. P. GLEASON MANUF'G CO.,

181 to 189 Mercer Street,

NEW YORK.

1889.

AT

4100

E 1

1888

CLASSICS

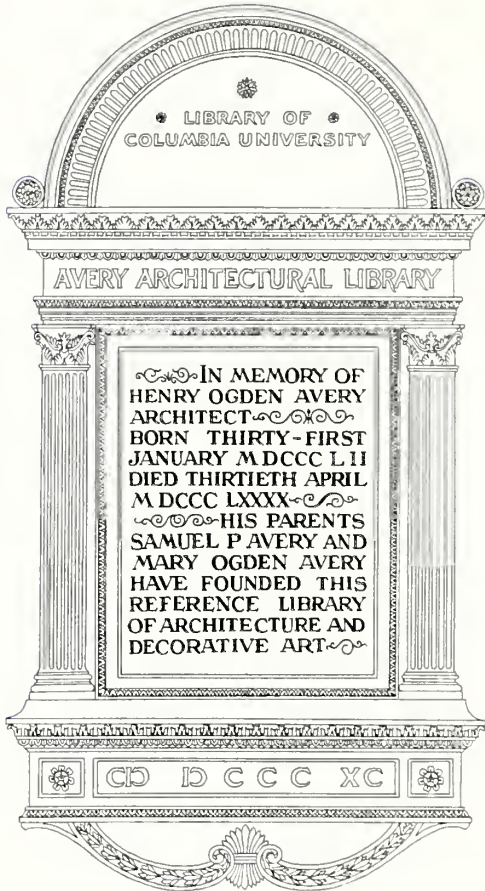

General

2/50



Digitized by the Internet Archive
in 2017 with funding from
Columbia University Libraries

DISCOUNT SHEET.

				<i>Pages.</i>	
Holder ^s ,	-	-	6-10,	50%	1/5 gro. lots, extra 5% 7/10 " " " " 10%
Fittings,	-	-	11-33,	50%	
Portables,	-	-	34-36,	50%	
Brackets,	-	-	37-44,	50%	
Chandeliers,	-	-	45-58,	50%	
Tin and Paper Shades,			59-64,	50%	
Wire Guards,	-		65-66,	50%	
Miscellaneous Goods,			66-82,	50%	
Reflectors,	-	-	83-88,	50%	
Shells or Ceiling Plates,			89-92,	50%	
Filament Lamps,	-		93-102,	50%	
Globes and Shades for Arc and Incandescent,			103-119,	50%	
Lanterns,	-	-	120-155,	50%	
Little McDonald Cut Outs,			156-160,	50%	

1888

E. P. GLEASON MFG. CO.



CATALOGUE OF ELECTRICAL APPLIANCES.

Office and Warerooms :

NEW YORK,
N. Y.

181 TO 189 MERCER ST.

E. P. GLEASON MFG. CO.

ELECTRIC LIGHT

GLOBES AND SHADES

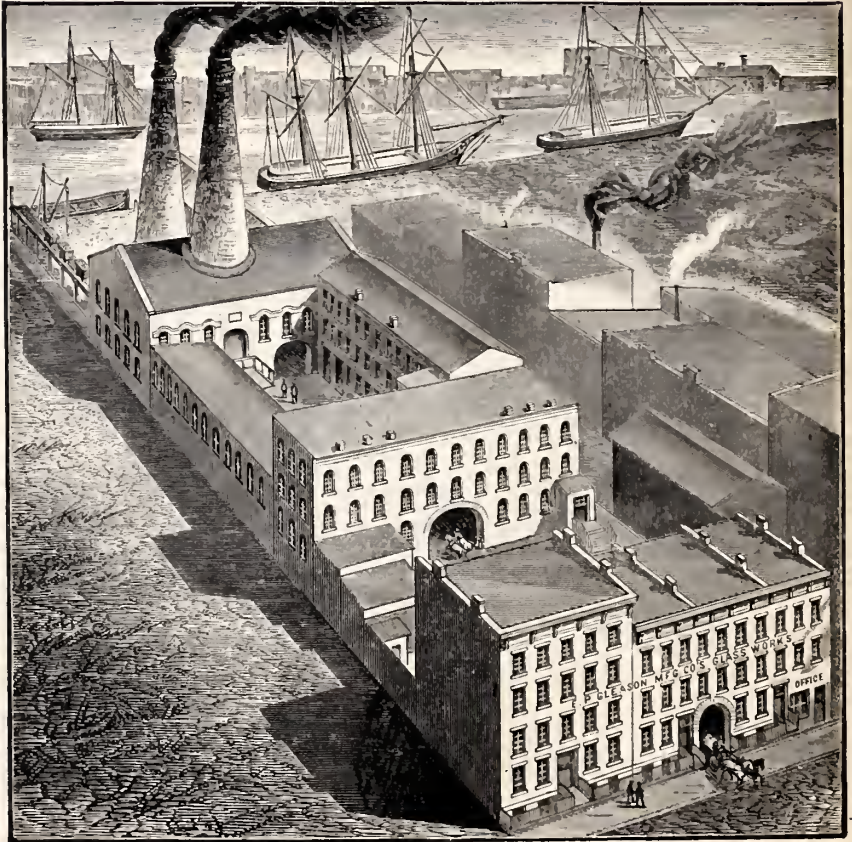

For Arc and Incandescent, in Flint, Opalescent, Cut, Sand Blast,
Etched, and Colors.

Glass Works :
*91 to 99 Commercial Street,
Greenpoint, N. Y.*

New York Office :
*181 to 189 Mercer Street,
New York, N. Y.*

Concerning the Purchase of Goods.

Accounts which are not otherwise agreed on, are payable 30 Days from date of Invoice, and monthly accounts on the 15th of each month.

Bills and accounts not promptly paid as above are subject to draft.

Packages charged at cost, no charge for cartage.

Our liability ceases after we have obtained the carrier's receipt (in good order). We assume no responsibility for breakage.

The greatest possible care will be taken to fill orders promptly and accurately. If orders are not perfectly clear, we will write for fuller instructions, but when they are filled as ordered, they cannot be returned without special agreement.

If there is any doubt regarding IRON PIPE SIZES, refer to our Chart on next page.

All goods will be sent C. O. D., unless satisfactory references accompany the order.

E. P. GLEASON MFG. CO.

Mercer & Houston Streets,

(Electric Light Department.)

NEW YORK.

IRON PIPE SIZES.

Actual Outside Dia. Inches.	No. of Threads per Inch.	TRADE NAME ↓	Nominal Thickness. Inches.	Weight per Running Foot.
0.405	27	$\frac{1}{8}$.068	0.24
0.54	18	$\frac{1}{4}$.088	0.42
0.675	18	$\frac{3}{8}$.091	0.56
0.84	14	$\frac{1}{2}$.109	0.84
1.05	14	$\frac{3}{4}$.113	1.12
1.315	11½	1	.134	1.67
1.66	11½	$1\frac{1}{4}$.140	2.25
1.9	11½	$1\frac{1}{2}$.145	2.69
2.375	11½	2	.154	3.66

ACTUAL SIZES.

Copyrighted by E. F. GENNERT, 1888.

The above represents a centre sectional view of Iron Pipe from $\frac{1}{8}$ to 2 inches, each piece being $\frac{1}{2}$ inch long, showing actual diameter of pipe, size of threads, etc., etc.

To those not versed in Iron Pipe Sizes—and even gas-fitters are puzzled sometimes—this Chart will come in handy when any doubt exists regarding drops in ceilings or walls, or when size of fittings is questioned; and if consulted there will be no excuse for any one to order fittings for “ $\frac{1}{2}$ -inch Iron Pipe” when they really want $\frac{1}{4}$ -inch Iron Pipe, etc.

INDEX TO FIGURES.

FIG.	PAGE
E 1, E 2, E 3, E 4, E 5, E 6	103
E 7, E 8, E 9, E 10, E 11, E 12	104
E 13, E 14, E 15, E 16, E 17, E 18	105
E 19, E 20, E 21, E 22, E 23, E 24	106
E 25, E 26, E 27, E 28, E 29, E 30	107
E 31, E 32, E 33, E 34, E 35, E 36	108
E 37, E 38, E 39, E 40, E 41, E 42	109
E 43, E 44, E 45, E 46, E 47, E 48	110
E 49, E 50, E 51, E 52, E 53, E 54	111
E 55, E 56, E 57, E 58, E 59	112
E 60, E 61, E 62, E 63	113
E 64, E 65, E 67, E 68	114
E 69, E 70, E 71, E 72	115
E 73, E 74	116
E 75, E 76	117
E 77, E 78	118
E 79	119
E 249	83
E 250	84
E 251	85
E 252, E 253	86
E 254, E 255, E 256	87
E 257, E 258, E 259, E 260, E 261	88
E 325, E 326, E 327	89
E 328, E 329, E 330	90
E 331	91
E 332	92
E 400, E 401	6
E 402, E 403	7
E 404½	8
E 405, E 406, E 407	9
E 408	10
E 450, E 451, E 452, E 453, E 454	11
E 455, E 457, E 458, E 459, E 460, E 461, E 461½, E 462	12
E 463, E 464	13
E 465, E 465½	14
E 468, E 469	15
E 470, E 471	16
E 472, E 473, E 474	17
E 475, E 476, E 477	18
E 478, E 479	19
E 479½, E 480, E 480½, E 481, E 481½	20
E 482, E 483	21
E 484, E 485, E 486, E 487, E 488	22
E 489, E 490	23
E 491, E 492	24
E 493, E 494, E 495	25
E 496	26
E 497	27
E 498, E 499	28
E 500	29
E 501	30
E 502	31
E 503, E 504	32
E 505, E 506, E 507	33
E 700, E 701	34
E 702, E 703	35
E 704, E 705	36
E 745, E 746	37
E 747, E 748	38
E 749	39
E 750, E 751, E 752, E 753, E 754	40
E 755, E 756, E 757, E 758	41
E 759, E 760	42
E 761, E 762	43
E 763, E 764	44
E 765	45
E 766	46
E 767	47
E 768	48
E 769	49
E 770	50
E 771	51
E 772	52
E 773	53
E 774	54

FIG.	PAGE
E 775	55
E 776	56
E 777	57
E 778	58
E 800, E 801, E 802	59
E 803, E 804	60
E 805, E 806	61
E 807, E 808	62
E 809, E 810	63
E 811	64
E 900, E 901, E 902, E 903	65
E 904, E 904½, E 905	66
E 906, E 907	67
E 908, E 909	68
E 909½	69
E 910, E 910½, E 911	70
E 912, E 913	71
E 914, E 915	72
E 916	73
E 917	74
E 918	75
E 919, E 920	76
E 921, E 922, E 923, E 924, E 925, E 926	77
E 927, E 928, E 929, E 930, E 931, E 932, E 933	78
E 934, E 935, E 936	79
E 937, E 938, E 939, E 941	80
E 942	81
E 943	82
E 1073	120
E 1074	121
E 1075	122
E 1076	123
E 1077	124
E 1078	125
E 1079	126
E 1080	127
E 1081	128
E 1082	129
E 1083, F 1084	130
E 1088	131
E 1096	132
E 1097	133
E 1098	134
E 1099, E 1100	135
E 1101	136
E 1102, E 1103	137
E 1104	138
E 1105	139
E 1106	140
E 1108	141
E 1110	142
E 1111	143
E 1112	144
E 1113	145
E 1115	146
E 1116	147
E 1117	148
E 1118, E 1119	149
E 1120	150
E 1121	151
E 1122	152
E 1123, E 1124	153
E 1125	154
E 1126, E 1127	155
E 1250	93
E 1256	94
E 1257, E 1259, E 1260	95
E 1264	96
E 1265	97
E 1266	98
E 1267, E 1268, E 1269	99
E 1270, E 1271	100
E 1272, E 1273	101
E 1274	102
E 1300, E 1301, E 1302	158
E 1303	159
E 1304, E 1305	160

PATENT FANCY BAND HOLDER.

Patented July 5, 1884 ; May 8, 1888.

Fits $\frac{1}{8}$ Nozzle.



E 400.

FINISHED IN POLISHED BRASS OR GOLD.

2¼-in.	Per gross.....	\$30 00
3¼ " "	" ".....	35 00
4 " "	" ".....	37 50
5 " "	" ".....	45 00

SHADOWLESS SPRING-HOLDER.

FOR CONE OR UPRIGHT SHADES.

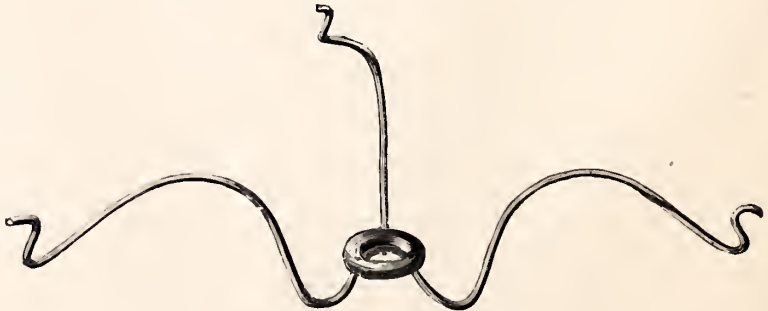

E 401.

8, 10 and 12-in. Fits $\frac{1}{8}$ Nozzle.

Per gross.....	\$30 00
----------------	---------

PATENT SHADE HOLDER.

Patented July 1, 1884.



E 402.

2¼, 3¼ and 4-inch. Fits ½ Nozzle.

2¼-inch, per gross.....	\$26 00
3¼ " " ".....	26 00
4 " " ".....	33 50

CLAMP SOCKET SHADE HOLDER.

Patented July 1, 1884.

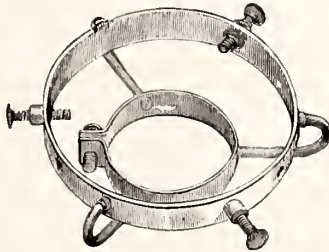

E 403.

2¼, 3¼ and 4-inch.

2¼-inch, per gross.....	\$26 00
3¼ " " ".....	33 50
4 " " { FANCY BAND, like E 400 {	37 50
5 " " {	45 00

In ordering Clamp Holders, state name of *Filament Lamp in use.*

GLEASON'S IMPROVED SOCKET CLAMP HOLDER.

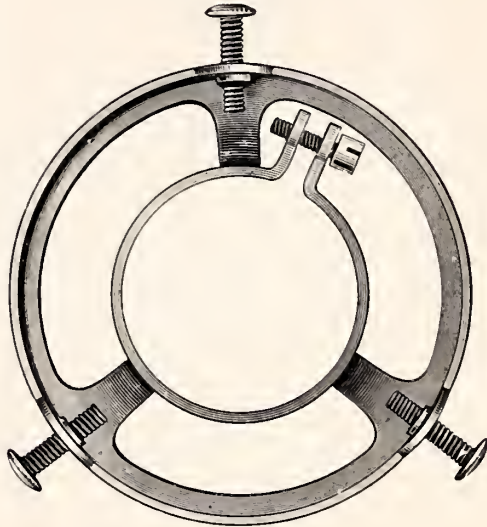
Patented July 3, 1888.

E 404½.

FINISHED IN POLISHED BRASS AND GOLD.

2¼-inch, per gross.....	\$20 00
3¼ " "	25 00

In ordering Clamp Holders, state name of *Filament Lamp in use.*

TRIPOD HOLDER.

Height, 3 in.

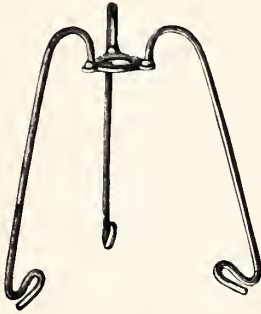

E 405.

(To fit Tin Shades, Figs. E 800, 801, 802.)

2¼, 3¼ and 4-in.

Fits ⅙ Nozzle.

Price, per gross.....\$8.75

TRIPOD HOLDER.

Height, 4 in.

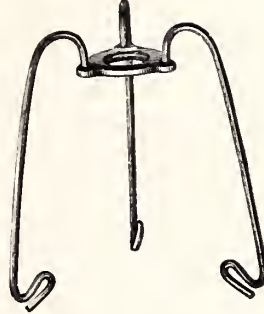

E 406.

(To fit Tin Shades, Figs. E 800, 801, 802.)

2¼, 3¼ and 4-in.

Fits ⅜ Iron Pipe.

Price, per gross.....\$15.00

SHADOWLESS TRIPOD CLAMP SOCKET SHADE HOLDER.

FOR OPAL SHADES. EXTRA HEAVY WIRE.

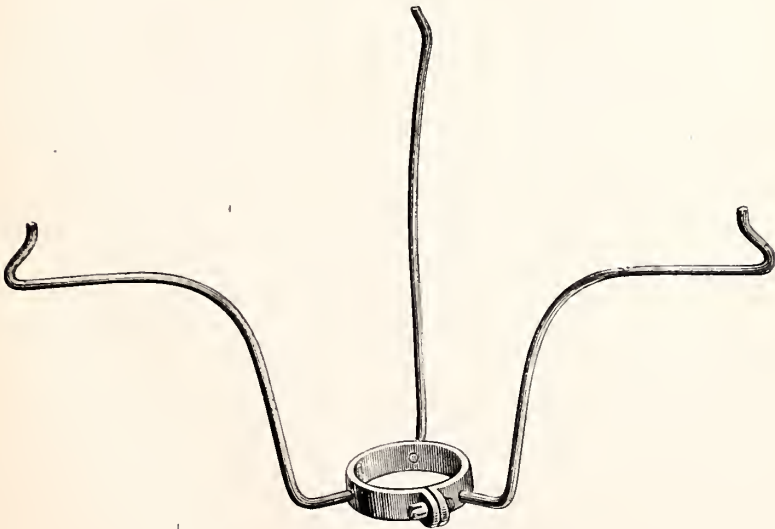

E 407.

8, 9, 10 and 12-in.

Made to fit any Socket.

Price, per gross.....\$50.00

CAST BRASS CLAMP SOCKET SHADE HOLDER.

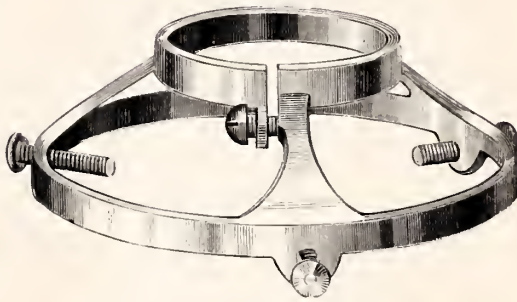

E 408.

FINISHED IN POLISHED BRASS.

In stock sizes that fit the Swan and Vitrile Filament Lamp Sockets.

Can be made (to order) to fit any Socket.

2 $\frac{1}{4}$ in., per gross.....	\$26 00
3 $\frac{1}{4}$ " "	33 50

TURNED FITTINGS, FINISHED IN POLISHED BRASS OR GOLD.

Straight Nozzle.

POLISHED BRASS OR GOLD.

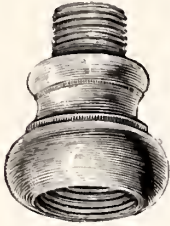

E 450.

$\frac{3}{8}$ X $\frac{3}{8}$	Brass, per doz.....	\$2 12
$\frac{7}{16}$ X $\frac{3}{8}$	" "	2 50
$\frac{1}{2}$ X $\frac{3}{8}$	" "	2 75
$\frac{5}{8}$ X $\frac{3}{8}$	" "	3 10

L Nozzle.

POLISHED BRASS OR GOLD.

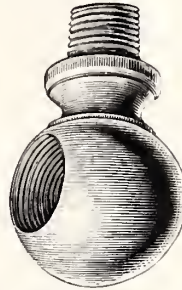

E 451.

$\frac{3}{8}$ X $\frac{3}{8}$	Brass, per doz.....	\$2 50
$\frac{7}{16}$ X $\frac{3}{8}$	" "	2 75
$\frac{1}{2}$ X $\frac{3}{8}$	" "	3 10
$\frac{5}{8}$ X $\frac{3}{8}$	" "	3 50

Brass Lengthening Piece.

POLISHED BRASS OR GOLD.

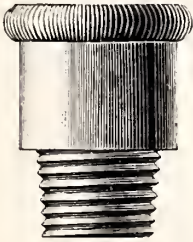

E 452

$\frac{1}{4}$ X $\frac{1}{4}$	Iron, per doz.....	\$3 00
$\frac{3}{8}$ X $\frac{3}{8}$	" "	3 00

Turned Stiff Joint.

POLISHED BRASS OR GOLD.

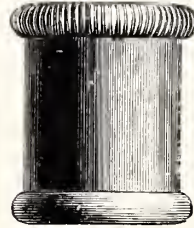

E 453.

$\frac{3}{8}$ X $\frac{1}{8}$	Iron, per doz.....	\$3 50
$\frac{3}{8}$ X $\frac{1}{4}$	" "	3 75
$\frac{3}{8}$ X $\frac{3}{8}$	" "	4 00
$\frac{1}{2}$ X $\frac{1}{4}$	" "	4 50
$\frac{1}{2}$ X $\frac{3}{8}$	" "	5 00
$\frac{1}{2}$ X $\frac{1}{2}$	" "	5 50

Polished Brass Cap.

$\frac{1}{8}$, $\frac{1}{4}$, $\frac{3}{8}$ and $\frac{1}{2}$ -inch, Iron.



E 454.

$\frac{1}{8}$, per doz.....	\$3 50	$\frac{3}{8}$, per doz.....	\$4 00
$\frac{1}{2}$, "	3 75	$\frac{1}{2}$, "	5 50

FINISHED BRASS FITTINGS.

Straight Nozzle.



E 456.

$\frac{1}{8}$ x $\frac{1}{8}$	Iron, per doz.....	\$1 00
$\frac{1}{4}$ x $\frac{1}{8}$	" "	1 70
$\frac{3}{8}$ x $\frac{1}{8}$	" "	1 70

Side Nozzle.

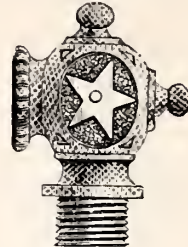

E 457.

$\frac{1}{8}$ x $\frac{1}{8}$	Iron, per doz.....	\$1 00
$\frac{1}{4}$ x $\frac{1}{8}$	" "	1 70
$\frac{3}{8}$ x $\frac{1}{8}$	Brass x $\frac{1}{8}$ Iron, per doz.....	1 70
$\frac{1}{2}$ x $\frac{1}{8}$	" "	1 70

Stiff Joint.

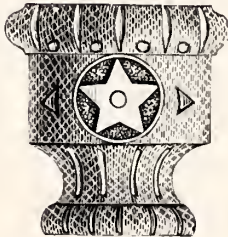

E 458.

$\frac{3}{8}$ x $\frac{1}{8}$	Iron, per doz.....	\$1 40
$\frac{3}{8}$ Iron x $\frac{7}{16}$	Brass, per doz.....	1 50
$\frac{3}{8}$ " x $\frac{1}{2}$	" "	1 50
$\frac{3}{8}$ x $\frac{1}{4}$	Iron, per doz.....	1 50
$\frac{3}{8}$ x $\frac{3}{8}$	" "	1 70
$\frac{1}{2}$ x $\frac{1}{8}$	" "	2 00
$\frac{1}{2}$ x $\frac{1}{4}$	" "	2 00
$\frac{1}{2}$ x $\frac{3}{8}$	" "	2 00
$\frac{1}{2}$ x $\frac{1}{2}$	" "	2 90

Connecting Ball.



E 459.

$\frac{5}{16}$ x $\frac{5}{16}$	Brass, per doz.....	\$0 80
$\frac{3}{8}$ x $\frac{3}{8}$	" "	1 10
$\frac{7}{16}$ x $\frac{7}{16}$	" "	1 40
$\frac{1}{2}$ x $\frac{1}{2}$	" "	1 40
$\frac{5}{8}$ x $\frac{5}{8}$	" "	1 70

Extension Piece.

Iron Thread, $\frac{1}{4}$ x $\frac{1}{4}$.

Male Nipple.



E 461.

$\frac{3}{4}$ Brass x $\frac{1}{4}$ Brass.
Per gross, \$6.00.



E 461 1/2.

Per gross, \$6.00.

Brass Nipples.

Iron Thread, $\frac{1}{4}$ x $\frac{1}{4}$.



E 462.

Per gross, \$8.00.

Bushings.



E 460.

$\frac{1}{4}$ x $\frac{1}{4}$	Iron, per doz..	\$0 70
$\frac{3}{8}$ x $\frac{3}{8}$	" " ..	80
$\frac{1}{2}$ x $\frac{3}{8}$	" " ..	1 10
$\frac{3}{4}$ x $\frac{1}{2}$	" " ..	1 40
1 x $\frac{3}{4}$	" " ..	1 70

CHANDELIER INSULATED JOINT.

FOR ELECTRIC LIGHT FIXTURES ONLY.

Patented Nov. 22, 1887.

Female both ends.

$\frac{3}{8}$ x $\frac{1}{8}$	} each.....\$1 40
$\frac{3}{8}$ x $\frac{1}{4}$		
$\frac{3}{8}$ x $\frac{3}{8}$		
$\frac{1}{2}$ x $\frac{1}{8}$	}	1 65
$\frac{1}{2}$ x $\frac{1}{4}$		
$\frac{1}{2}$ x $\frac{3}{8}$		
$\frac{3}{4}$ x $\frac{1}{8}$	}	2 50
$\frac{3}{4}$ x $\frac{1}{4}$		
$\frac{3}{4}$ x $\frac{3}{8}$		
$\frac{3}{4}$ x $\frac{1}{2}$	}	3 50
$\frac{3}{4}$ x $\frac{3}{4}$		
$\frac{3}{4}$ x 1		
1 x $\frac{1}{8}$	}	5 00
1 x $\frac{1}{4}$		
1 x $\frac{3}{8}$		
$1\frac{1}{4}$ x $1\frac{1}{4}$	}	10 00
$1\frac{1}{2}$ x $1\frac{1}{2}$		
2 x 2	}	12 00

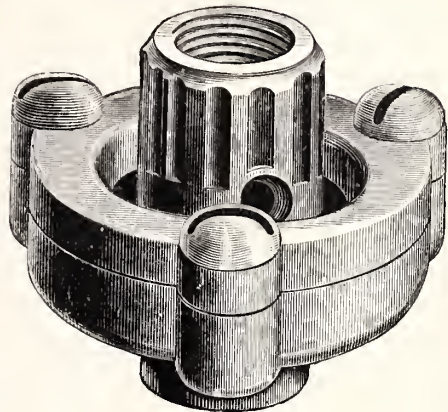

E 463.

Our Insulating Joint is unlike any other in construction, being neither a union nor a pair of insulated disk flanges, but it is a cupped flange which embraces a flanged nipple, and forms a body in which the insulation is inclosed; all secured against twisting or turning by steel screws which pass through and enter into solid metal.

The inner insulation is impervious to gas and its accompanying moisture; the outer insulation is a washer of vulcanized fiber, which does not come in contact with the gas. In some instances, pure gum washers have been substituted.

This fitting cannot be strained, short-circuited, or injured in ordinary use, and has been well received wherever shown. It has been adopted by nearly all the parent incandescent electric light companies, they having them in use and for sale.

CHANDELIER INSULATED JOINT.

FOR COMBINATION GAS AND ELECTRIC FIXTURES.

Patented Nov. 22, 1887.

Female both ends.

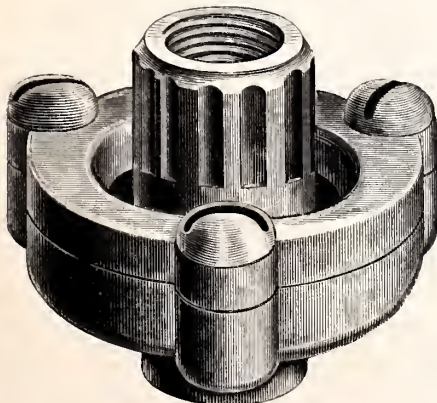

E 464

$\frac{3}{8}$ x $\frac{1}{8}$	} each.....\$1 40
$\frac{3}{8}$ x $\frac{1}{4}$		
$\frac{3}{8}$ x $\frac{3}{8}$		
$\frac{1}{2}$ x $\frac{1}{8}$	}	1 65
$\frac{1}{2}$ x $\frac{1}{4}$		
$\frac{1}{2}$ x $\frac{3}{8}$		
$\frac{3}{4}$ x $\frac{1}{8}$	}	2 50
$\frac{3}{4}$ x $\frac{1}{4}$		
$\frac{3}{4}$ x $\frac{3}{8}$		
$\frac{3}{4}$ x $\frac{1}{2}$	}	3 50
$\frac{3}{4}$ x $\frac{3}{4}$		
$\frac{3}{4}$ x 1		
1 x $\frac{1}{8}$	}	5 00
1 x $\frac{1}{4}$		
1 x $\frac{3}{8}$		
$1\frac{1}{4}$ x $1\frac{1}{4}$	}	10 00
$1\frac{1}{2}$ x $1\frac{1}{2}$		
2 x 2	}	12 00

BRACKET INSULATED JOINT.

FOR COMBINATION GAS AND ELECTRIC FIXTURES.

Female both ends.

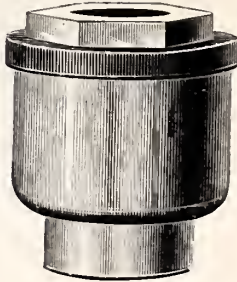

E 465.

$\left. \begin{array}{l} \frac{3}{8} \times \frac{1}{8} \\ \frac{3}{8} \times \frac{1}{4} \\ \frac{3}{8} \times \frac{3}{8} \end{array} \right\}$	each.....	\$0.80	$\left \begin{array}{l} \frac{1}{2} \times \frac{1}{8} \\ \frac{1}{2} \times \frac{1}{4} \\ \frac{1}{2} \times \frac{3}{8} \end{array} \right\}$	each.....	\$1.00
---	-----------	--------	---	-----------	--------

BRACKET INSULATED JOINT.

FOR COMBINATION GAS AND ELECTRIC FIXTURES.

Male and Female.

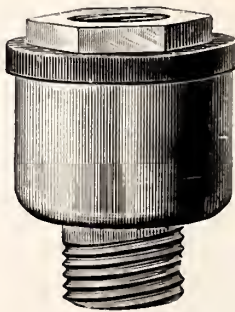

E 465½.

$\left. \begin{array}{l} \frac{3}{8} \times \frac{1}{8} \\ \frac{3}{8} \times \frac{1}{4} \\ \frac{3}{8} \times \frac{3}{8} \end{array} \right\}$	each.....	\$0.80	$\left \begin{array}{l} \frac{1}{2} \times \frac{1}{8} \\ \frac{1}{2} \times \frac{1}{4} \\ \frac{1}{2} \times \frac{3}{8} \end{array} \right\}$	each.....	\$1.00
---	-----------	--------	---	-----------	--------

INSULATED CEILING PLATE FOR SUSPENDING LAMPS.

POLISHED BRASS OR BRONZE.

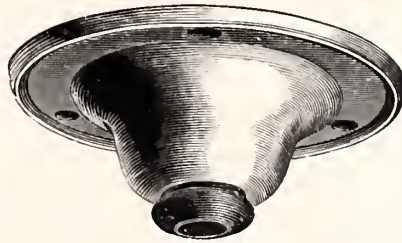

E 468.

Per doz.....\$5.00

BRASS CEILING FLANGE FOR ELECTROLIERS.

FINISHED IN POLISHED BRASS OR GOLD.

MALE THREAD.

Extra Heavy Cast.

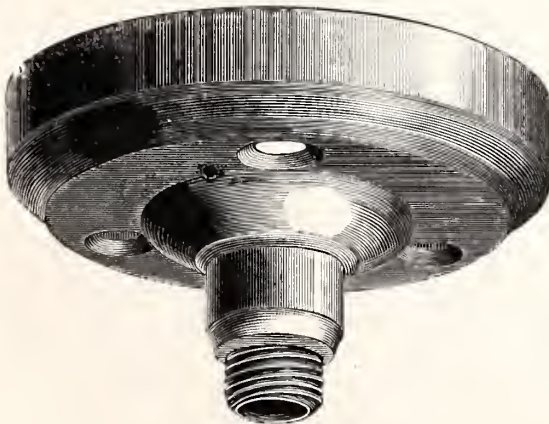

E 469.

Diameter, 3 inches.

Threaded, $\frac{1}{4}$ nipple, per doz.....	\$6 25
“ $\frac{3}{8}$ “ “	6 50
“ $\frac{1}{2}$ “ “	7 00

CAST BRASS BRACKET WALL PLATE OR BRACKET BACK.

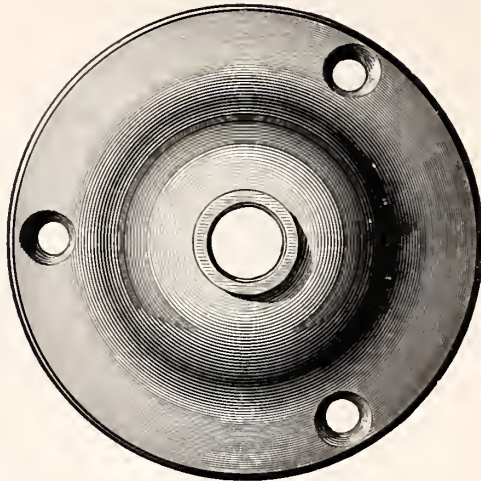

E 470.

Plain Lacquer, per doz.....	\$3 00
Polished Brass or Gold, per doz.....	4 00

CAST IRON CHANDELIER BODY.

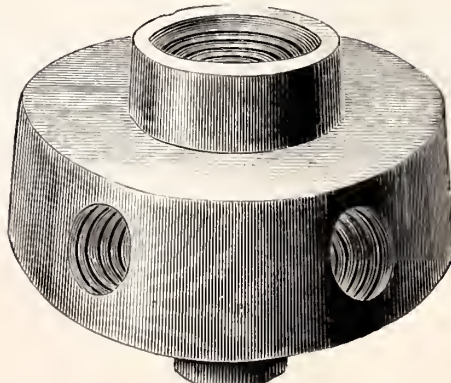

E 471.

2-Light, each.....	\$0 35
3 " ".....	50
4 " ".....	60
6 " ".....	1 00

TWO-LIGHT ADJUSTABLE CLUSTER.

Patented May 1, 1888.

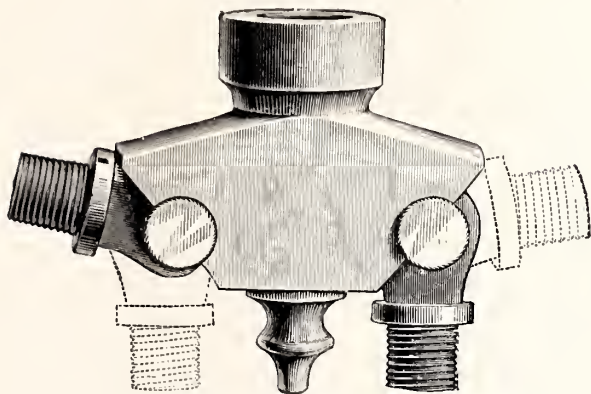

E 472.

Tapped to fit any size pipe.

Finished in Plain Brass, each...\$1.55 | Finished in Polished Brass or Gold, each, \$2.00

THREE-LIGHT ADJUSTABLE CLUSTER.

Patented May 1, 1888.

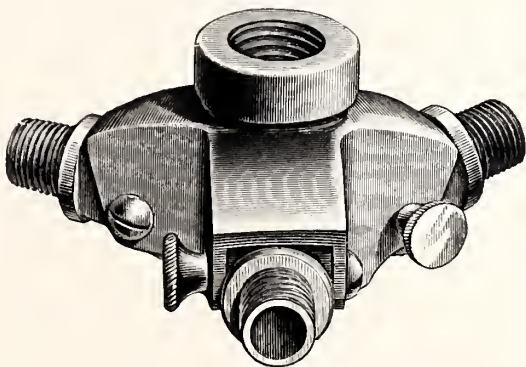

E 473.

Tapped to fit any size pipe.

Finished in Plain Brass, each...\$2.25 | Finished in Polished Brass or Gold, each, \$2.75

CLUSTER BALL.

Finished in Polished Brass or Gold.

From Two to Six Lights. Tapped any size.

2-Light, each.....	\$0 75
3 " "	1 00
4 " "	1 25
5 " "	1 70
6 " "	2 50

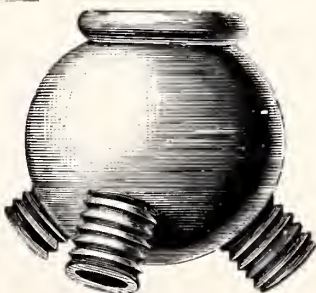

E 474.

IRON CROWFOOT.

Tapped from $\frac{1}{8}$ to $\frac{1}{2}$ inch. Iron.

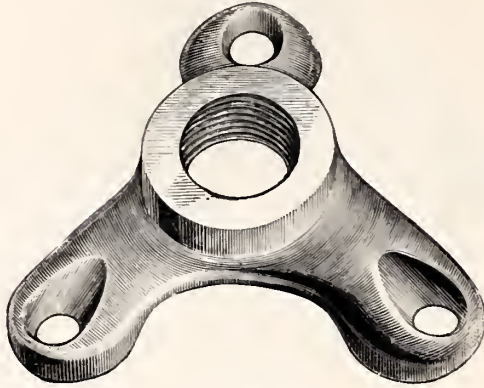

E 475.

Per dozen.....\$2.00

IRON TRIPOD.

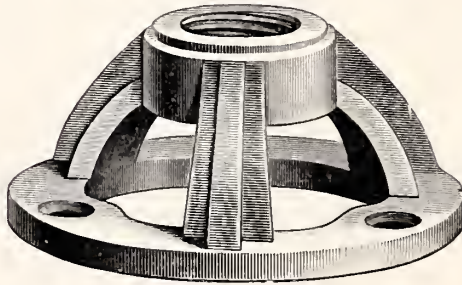

E 476.

$\frac{3}{8}$ -inch. per dozen.....\$1 95
 $\frac{1}{2}$ " " 2 25

IRON DEUPOD.

Tapped from $\frac{1}{8}$ to $\frac{1}{2}$ inch.

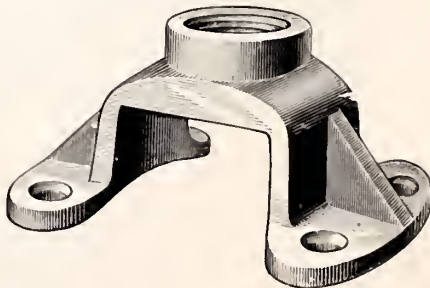

E 477

Per dozen.....\$2.00

STATION DYNAMO CONNECTION.

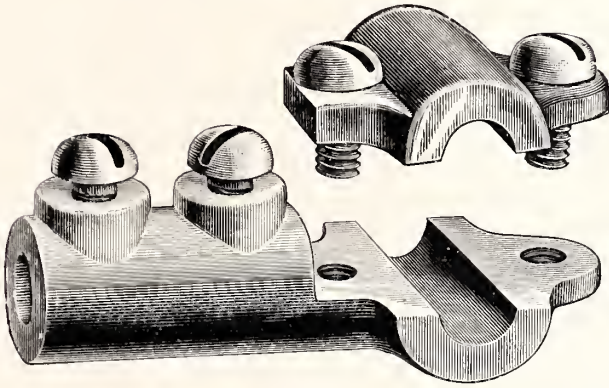

E 478.

Price, each.....\$1.00

FILAMENT LAMP ATTACHMENT.

$\frac{1}{8}$ Male Nipple with Wood Screw.



E 479.

Per dozen.....\$1.50

IMPROVED SEPARABLE GAS FIXTURE ATTACHMENT.

Patent Pending.

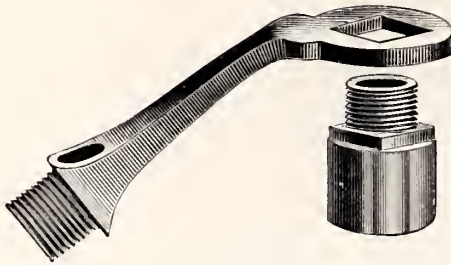

E 479½.

Length, 2 in. : finished polished brass.
Per doz.....\$4.00

The Improved Separable Gas Fixture Attachment.—The gas-burner is first taken off and the nozzle screwed on in its place. The Attachment is then fitted to the nozzle on the diamond-shaped shoulder leaving the full length of the thread on the nozzle for the gas-burner and gas shade-holder, if required.

GAS FIXTURE ATTACHMENT FOR FILAMENT LAMP.

Standard length, 2 in. Other lengths to order.

Per doz.....\$3.00

Polished Brass Attachment to Gas Fixture, positioned *under* the Burner to convert it into a Combination Gas and Electric Fixture.



E 480.

POLISHED HARD RUBBER NOZZLES.

FOR INSULATING PURPOSES.



E 480½.

½ Male x ½ Female.



E 481.

(Extra Heavy.)



E 481½.

Used on Flexible Cord Pendants to prevent rupture to insulating at the socket.

Insulates Filament Lamp from Fixture.

Price, per hundred...\$9.00

	Per doz.
1/8 x 1/8 Iron Thread..	\$1 50
1/4 x 1/8 " " ..	2 00
3/8 x 1/8 " " ..	2 50

Price, per hundred...\$9.00

MALE CHANDELIER HOOK DRILLED FOR WIRING.

1/4-inch, per dozen	\$4 00
3/8 " "	4 00
1/2 " "	4 00

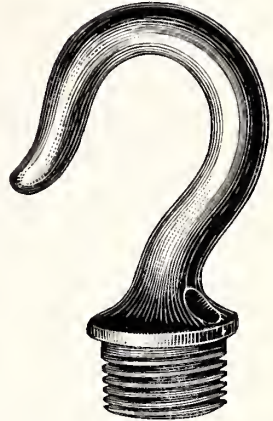

E 482.

IRON BRACKET OR CEILING FLANGE.

FINISHED IN FRENCH BRONZE.

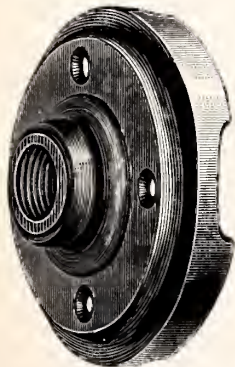

E 483.

The above Flange will prove a very useful fitting in the furnishing of cheap Pendants or Side Brackets for factory use, etc. Grooved at back for the reception of Wires.

Tapped for 1/8, 1/4 and 3/8-inch iron pipe.

Price, per dozen	\$3.00
------------------------	--------

In ordering, give size of iron pipe to be used.

**CLAMP GAS FIXTURE
ATTACHMENT.**

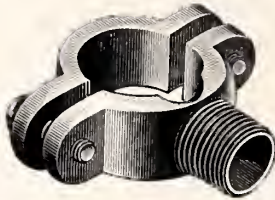

E 484.

Assorted sizes to fit Brass and Iron Pipe.

In ordering, give size of pipe, and if Brass or Iron.

Per doz. \$3.50

**FLEXIBLE RUBBER FITTING
TO FILAMENT LAMPS.**

When used on Silk Cord Pendants prevents tearing of the Insulating on the Cord.



E 485.

Per hundred \$3.75

**SCREW INSULATED FINISHING
PIECE.**

For Filament Lamps of any system when used on Cord Pendants.



E 486.

Per dozen \$2.50

BINDING POSTS.



E 487.

Other styles and sizes made to order from drawing or sample.

Give gauge and size of wire to be used.

Per dozen \$2.00

WIRE CONNECTORS.

Sizes from No. 0 to No. 20 Wire.

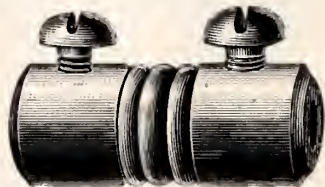

E 488.

Per dozen \$2.00

BOX CLUSTER.



E 489.

Stem Tapped for $\frac{3}{8}$ -in. Iron Pipe.

Finished in Polished Brass or Gold, with Removable Shell top and bottom for Wiring.

6-Light, each.....	\$3 75
8 " "	5 00
10 " "	7 50
12 " "	10 00
15 " "	15 00

ARM FIXTURE CLAMP (Insulated Center).

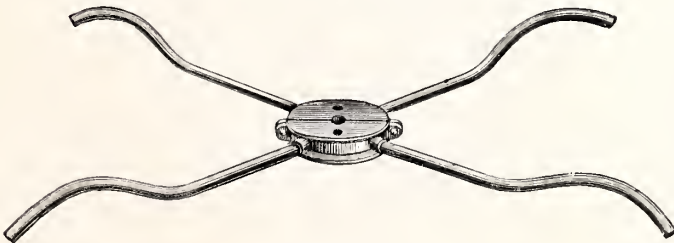

E 490.

36-in. spread.

A device that can be attached to the stem of almost any chandelier, converting it into a Combination Gas and Electric Light Fixture.

2-Light, each.....	\$3 25
3 " "	4 50
4 " "	5 00
6 " "	6 00

CEILING DROP LAMP ROSETTE.

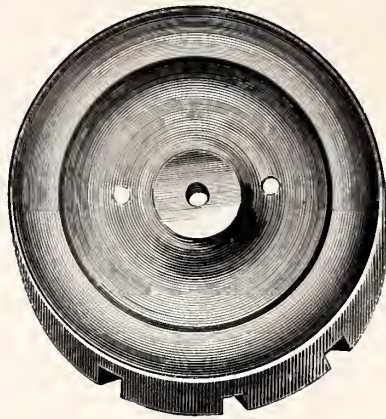

E 491.

WHITE WOOD.

Diameter, 4 in.; per hundred.....\$13.75

CEILING CHANDELIER BLOCK.

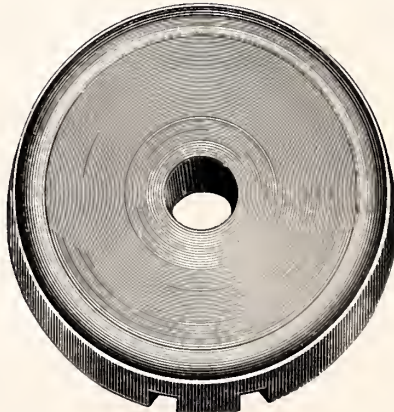

E 492.

WHITE WOOD.

Diameter, 4 in.; per hundred.....\$13.75

Ash.....	twice the price of White Wood.
Walnut.....	three times " "
Mahogany.....	six " "

WOODEN MOULDING FOR CONCEALED WIRING.

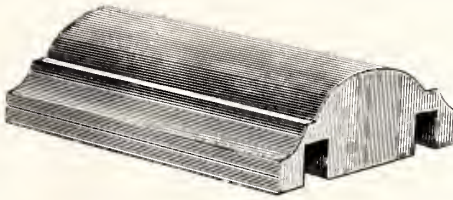

E 493.

WHITE WOOD.

Takes 14 to 24 Wire. Price per 1,000 feet..... \$20 00

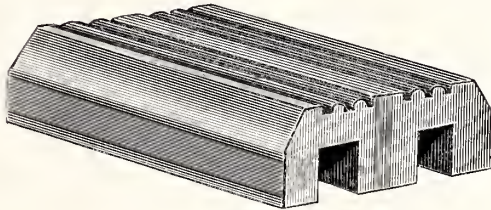

E 494.

WHITE WOOD.

No. 1, takes 10 to 14 Wire.	Price per 1,000 feet.....	\$25 00
No. 2, " 6 to 10 "	" " " "	27 00
No. 3, " 0 to 6 "	" " " "	29 00

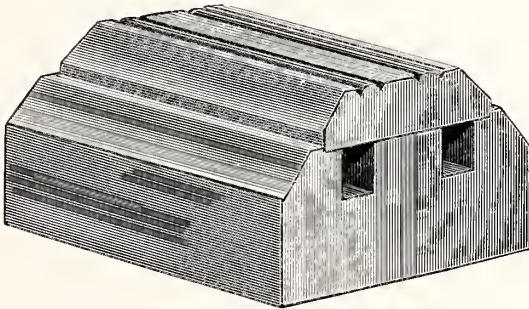

E 495.

WHITE WOOD.

No. 1, takes 10 to 14 Wire.	Price per 1,000 feet.....	\$50 00
No. 2, " 6 to 10 "	" " " "	55 00
No. 3, " 0 to 6 "	" " " "	65 00
No. 4, " 00 "	" " " "	125 00

Ash.....twice the price of White Wood.
 Walnut.....three times " "
 Mahogany.....six " "

MAPLE CLEATS FOR ELECTRIC LIGHT WIRES.

FULL SIZE CUT.

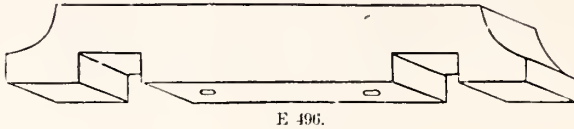

						Per 1,000.
$\frac{1}{8}$ -inch groove, for No. 14-16 Und. Wire						\$14 00
$\frac{3}{16}$	10-12	..	14 00
$\frac{1}{4}$	6-8	..	14 00
$\frac{3}{8}$	2-4	..	16 00
$\frac{1}{2}$	0-1	..	16 00
$\frac{5}{8}$	00	..	16 00

We use well-seasoned wood, and keep in stock the above sizes.

In ordering Cleats, give size the slots are required in fractions of an inch.

MAPLE ADJUSTING BALL.

FOR ADJUSTING FLEXIBLE PENDANTS.

Full size Cut.



E 497.

Price, per hundred \$7.50

HORSE SHOE.

DOUBLE POLE FUSIBLE CUT OUT FOR ELECTROLIERS OR COMBINATION FIXTURES.

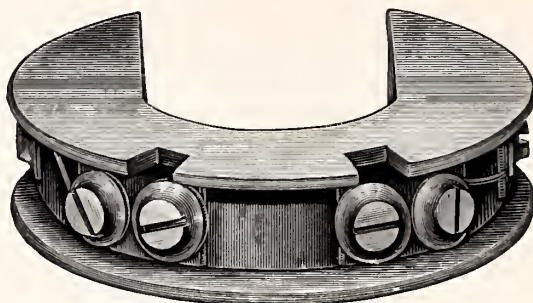

E 498.

Diameter, 2½ inches. Opening, 1¼ inches.

1 to 3-light :	price, per doz.....	\$6 50
4 “ 6 “ “ “ “	6 50
8 “ 12 “ “ “ “	6 50
12 “ 16 “ “ “ “	6 50

In ordering Cut Outs, give the number of lights they are to be connected to.

FUSIBLE CUT OUT COMBINATION BRACKETS.



E 499.

Price, per doz.....	\$6.00
---------------------	--------

INCANDESCENT SNAP SWITCHES.

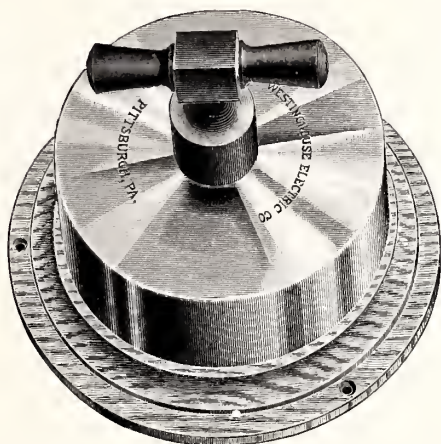

E 500.

5-Ampère Switch, each	\$2 25
10 " "	3 75
20 " "	5 25
30 " "	6 37
40 " "	7 50

**WALL SOCKET OR RECEPTACLES FOR ATTACHMENT PLUGS WHEN
USED ON ELECTRIC PORTABLES.**



E 501.

Price, each.....\$1.50

See cut of Attachment Plug, E 502.

ATTACHMENT PLUG FOR WALL SOCKET.

(Showing construction of Attachment Plug.)

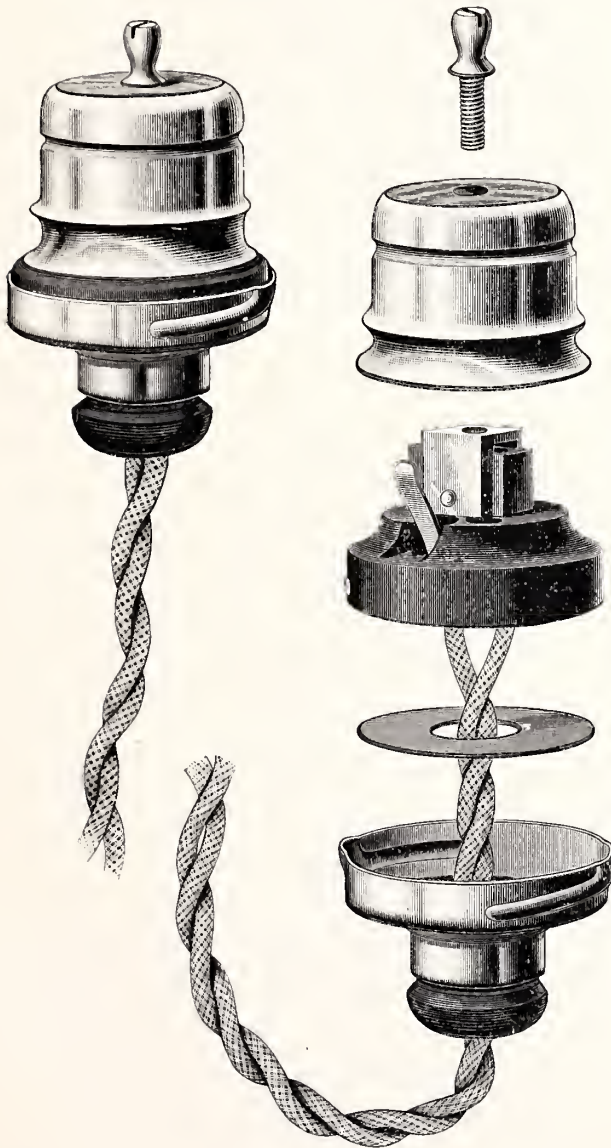

E 502.

Price, each.....\$1.25

FUSE WIRE.

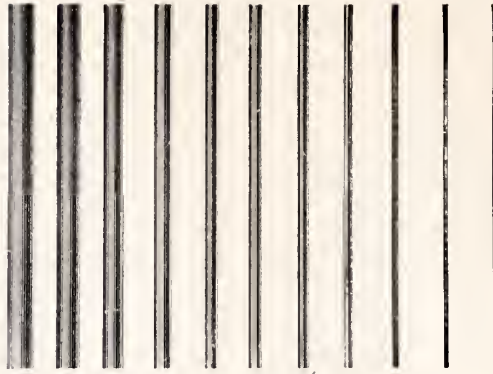

E 503.

2.16-Ampère, 1 to 3-Light, per 100 feet.....				\$5 00
4.32 " 6 " " " "				7 50
7.2 " 10 " " " "				7 50
10.8 " 15 " " " "				7 50
14.40 " 20 " " " "				10 00
18. " 25 " " " "				10 00
25. " 35 " " " "				10 00
36. " 50 " " " "				18 00
54. " 75 " " " "				18 00

YOKES WITH FUSE WIRE.

FOR RECHARGING CUT OUTS OR FUSE BOXES.

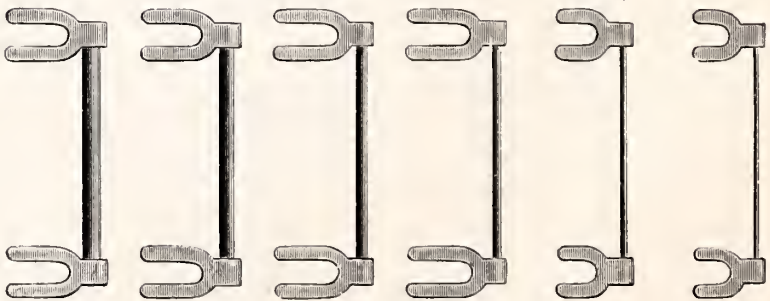

E 504.

3, 6, 10, 15, 25, 30, 50, 75 Lights.

Price, per hundred.....\$5.00

The above cuts represent full length. They are pliable and can be positioned in any Fuse Box or Cut Out. Other lengths made to order in lots of 500 or over.

In ordering Yokes, state number of lights or Ampère Current they are to carry.

BRANCH FUSIBLE CUT OUT.

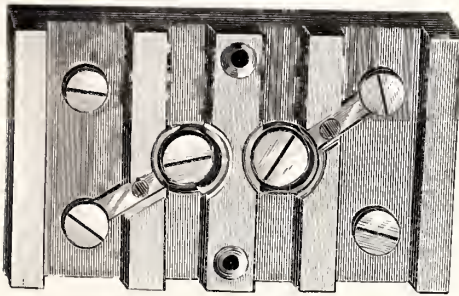

E 505.

4½ inches long, 3¾ inches wide ; price, per doz.....\$13.50

MAIN FUSIBLE CUT OUT.

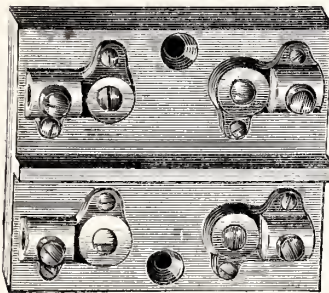

E 506.

3¼ inches long, 2¾ inches wide ; price per doz.\$13.50

B 000 CUT OUT.

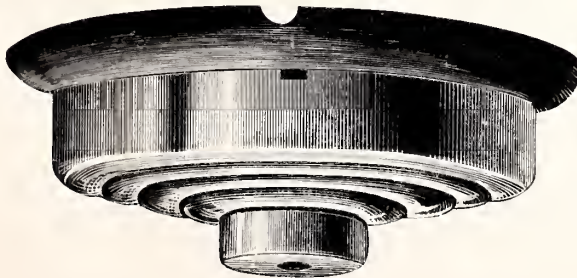

E 507.

Diameter 3 inches ; price, per doz.....\$13.50

ELECTRIC PORTABLES.



E 700.

Finished in Polished Brass or Gold. Height, 13 inches.

Price, each.....\$5.00



E 701.

Finished in Polished Brass or Gold. Height, 12 inches.

Price, each.....\$4.50

ELECTRIC PORTABLE.

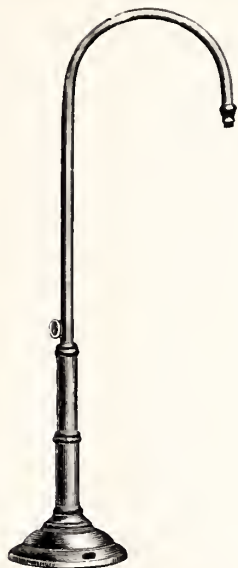

E 702.

Height, 23 in.; each.....\$6.00

EXTENSION ELECTRIC PORTABLE.



E 703.

Height, 18 in. (each).....\$12.00
Extended, 24 in.

ELECTRIC PORTABLE.



E 704.

FINISHED IN POLISHED BRASS OR GOLD.

Height, 18 in.; each.....\$8.50

EXTENSION ELECTRIC PORTABLE.



E 705.

FINISHED IN POLISHED BRASS OR GOLD.

Height, 18 in.; each.....\$10.00
Extended, 24 in. }

*Combination Brackets have Insulated Joints and are Wired.
Price does not include Lamps, Sockets, or Shades.*

COMBINATION GAS AND ELECTRIC BRACKETS.

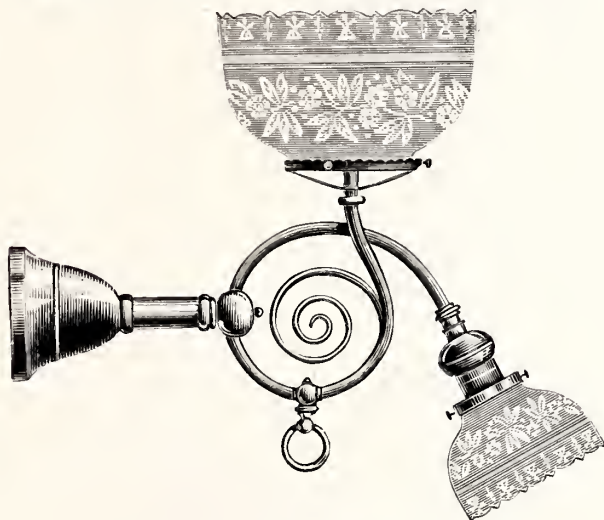

E 745.

FINISHED IN POLISHED BRASS OR GOLD.

Extends 13 inches ; each.....\$10.00

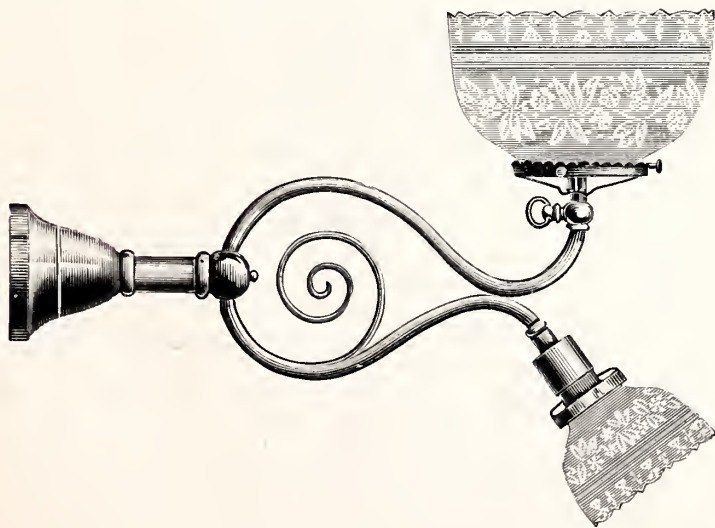

E 746.

FINISHED IN POLISHED BRASS OR GOLD.

Extends 18 inches ; each.....\$10.00

*Combination Brackets have Insulated Joints and are Wired.
Price does not include Lamps, Sockets, or Shades.*

COMBINATION GAS AND ELECTRIC BRACKETS.

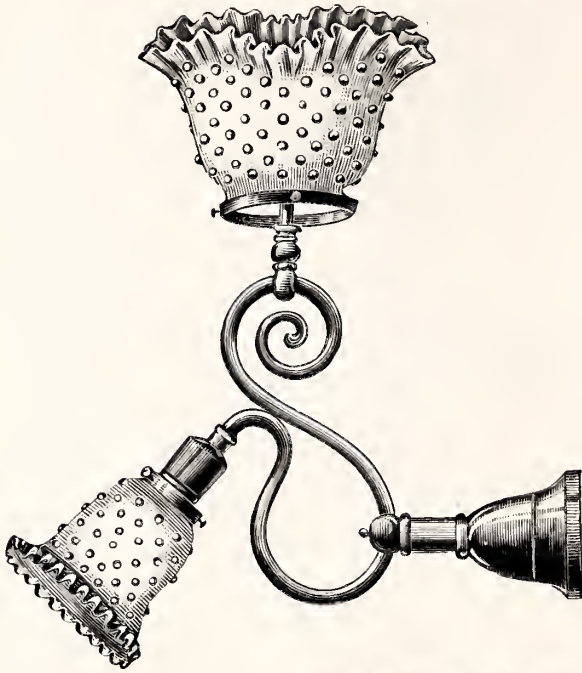

E 747.

FINISHED IN POLISHED
BRASS OR GOLD.

Extends 11 inches.

Each \$8.75



E 748.

FINISHED IN POLISHED
BRASS OR GOLD.

Extends 12 inches.

Each \$6.00

*Combination Brackets have Insulated Joints and are Wired.
Price does not include Lamp, Socket, or Shades.*

COMBINATION GAS AND ELECTRIC BRACKET.

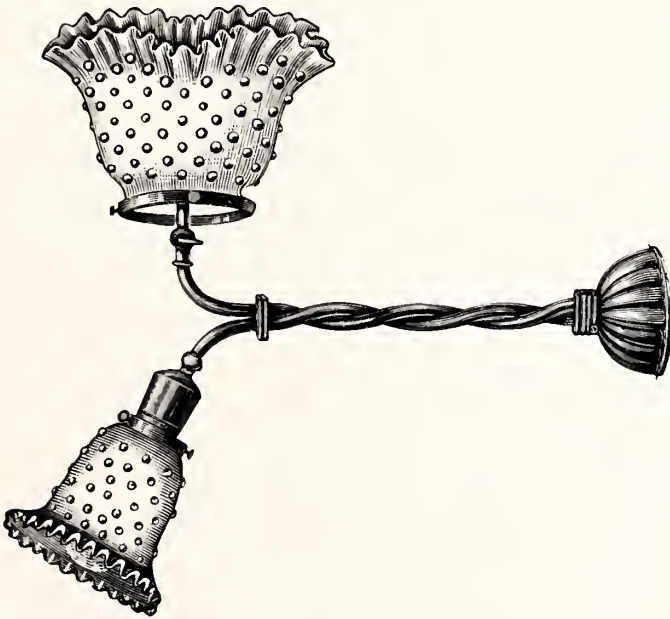

E 749.

FINISHED IN POLISHED BRASS OR GOLD.

Extends 12 inches; each.....\$8.00

BRASS BRACKETS.
FOR ELECTRIC LIGHT ONLY.



E 750.

LACQUERED.

6-inch, per doz.....	\$8 00
8 " " ".....	8 75
10 " " ".....	10 00
12 " " ".....	11 25

Finished in Polished Brass,
75c. per doz., net extra.



E 751.

LACQUERED.

6-inch, per doz.....	\$8 00
8 " " ".....	8 75
10 " " ".....	10 00
12 " " ".....	11 25

Finished in Polished Brass,
75c. per doz., net extra.



E 752.

POLISHED BRASS OR GOLD.

6-inch, per doz.....	\$10 00
8 " " ".....	10 75
10 " " ".....	11 25
12 " " ".....	12 00



E 753.

POLISHED BRASS OR GOLD.

6-inch, per doz.....	\$8 00
8 " " ".....	8 75
10 " " ".....	9 50
12 " " ".....	10 00



E 754.

POLISHED BRASS OR GOLD.

6-inch, per doz.....	\$12 50
8 " " ".....	13 25
10 " " ".....	13 75
12 " " ".....	14 25

NOTICE.

All Brackets can be made with Sliding Shell, 3-inch diameter, and Iron Crowfoot, at an advance of \$6.00 per doz. to list, subject to regular discount.

BRASS BRACKETS.



E 755.

FINISHED IN POLISHED BRASS OR GOLD.

6-inch, per doz.	\$15 00
8 " " "	15 75
10 " " "	16 25
12 " " "	17 00

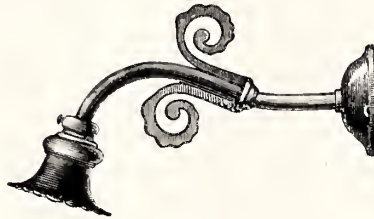

E 756.

FINISHED IN POLISHED BRASS OR GOLD.

Per doz.	\$45.00
----------	-------	---------



E 757.

FINISHED IN POLISHED BRASS OR GOLD.

6-inch, per doz.	\$10 00
8 " " "	10 75
10 " " "	11 25
12 " " "	12 00



E 758

FINISHED IN POLISHED BRASS OR GOLD.

6-inch, per doz.	\$10 00
8 " " "	10 75
10 " " "	11 25
12 " " "	12 00

NOTICE.

All Brackets can be made with Sliding Shell, 3-inch diameter, and Iron Crowfoot, at an advance of \$6.00 per doz. to list, subject to regular discount.

ELECTRIC BRACKETS.

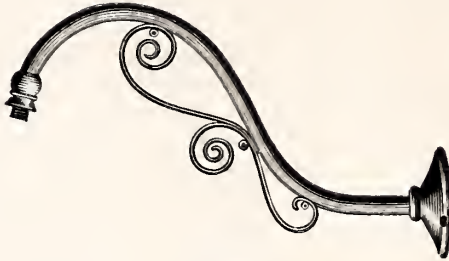

E 759.

12-inch, per doz.....\$20.00



E 760.

4-inch, per doz.....	\$12 50
6 " "	12 50
8 " "	13 25
10 " "	13 75
12 " "	14 25

NOTICE.

All Brackets can be made with Sliding Shell, 3-inch diameter, and Iron Crow-foot, at an advance of \$6.00 per doz. to list, subject to regular discount.

*Combination Brackets have Insulated Joints and are Wired.
Price does not include Lamps, Sockets, or Shades.*

COMBINATION GAS AND ELECTRIC BRACKET.



E 761.

FINISHED IN POLISHED BRONZE OR GOLD.

Including Imitation Candle.

Extends 12 in.; each.....\$9.00

TWO-LIGHT BRACKET.

FOR ELECTRIC LIGHT ONLY.



E 762.

FINISHED IN POLISHED BRASS OR GOLD.

Extends 15 in.; each.....\$8.00

*Combination Brackets have Insulated Joints and are Wired.
Price does not include Lamps, Sockets, or Shades.*

COMBINATION GAS AND ELECTRIC BRACKET.



E 763.

FINISHED IN POLISHED BRASS OR GOLD.

Spread, 18 in.: each..... \$15.00

COMBINATION GAS AND ELECTRIC BRACKET.

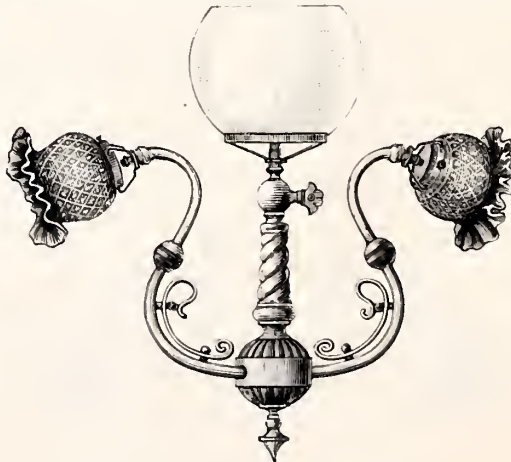

E 764.

FINISHED IN POLISHED BRASS OR GOLD.

Spread, 14 in.: each..... \$12.00

PLAIN TWO-LIGHT PENDANT.

FOR ELECTRIC LIGHT ONLY.

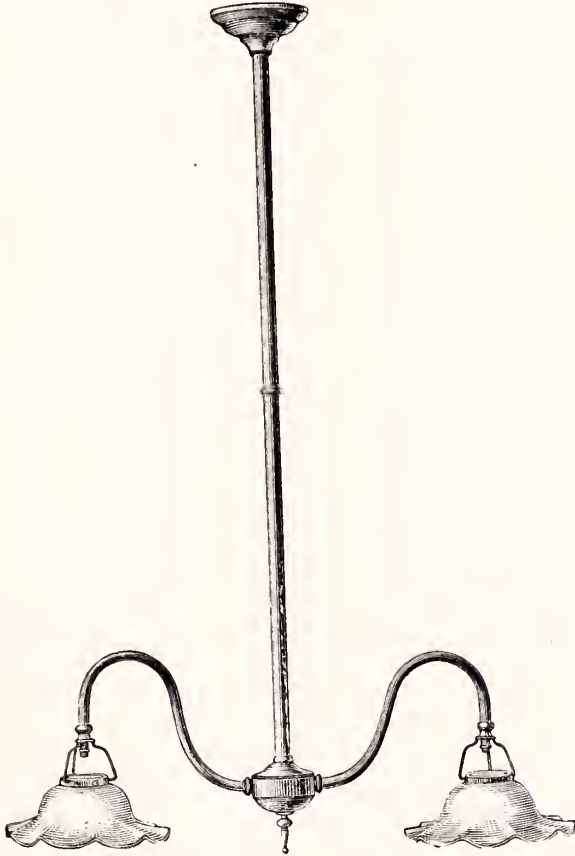

E 765.

FINISHED IN POLISHED BRASS OR GOLD.

Wired and with Insulated Joints—less Glassware.

Length, 40 in.; spread, 18 in.: each.....\$9.00

*Fixtures have Insulated Joints and are Wired.
Prices do not include Lamps, Sockets, or Shades.*

FANCY TWO-LIGHT PENDANT.

FOR ELECTRIC LIGHT ONLY.



E 766.

FINISHED IN POLISHED BRASS OR GOLD.

Length, 40 in.; spread, 30 in.

2-Light—	Electric; each.....	\$15 00
3 “	“ “	20 00
4 “	“ “	25 00
5 “	“ “	35 00

*Combination Chandeliers have Insulated Joints and are Wired.
Prices do not include Lamps, Sockets or Shades.*

COMBINATION GAS AND ELECTRIC CHANDELIER.

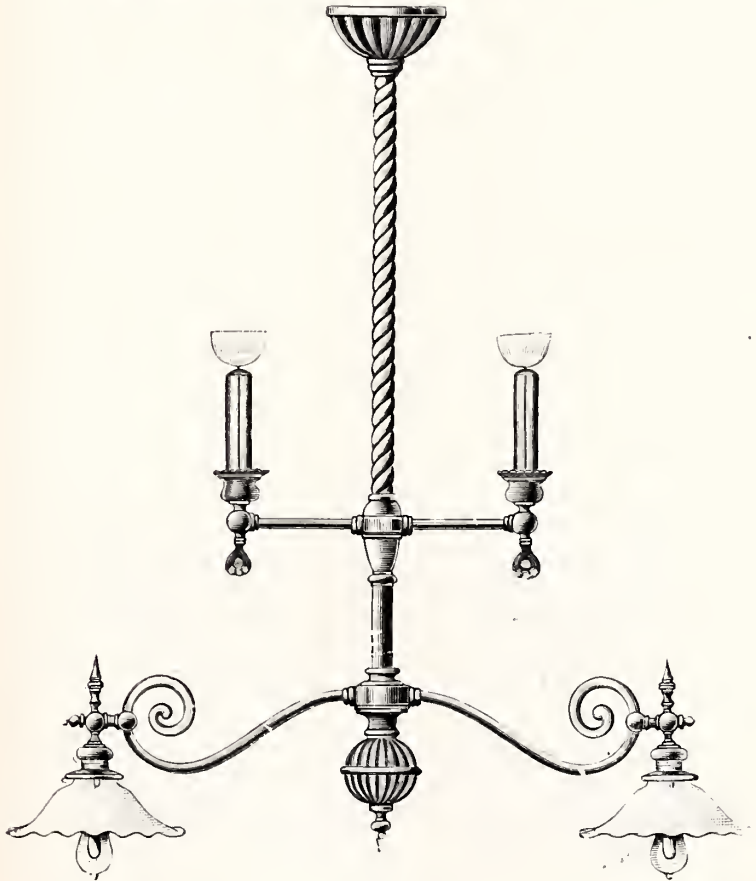

E 767.

FINISHED IN POLISHED BRASS OR GOLD.

Length, 40 in.

4-Light, 2 Gas and 2 Electric; each.....	\$48 00
6 " 3 " 3 " " "	25 00
8 " 4 " 4 " " "	30 00
12 " 6 " 6 " " "	45 00

*Combination Chandeliers have Insulated Joints and are Wired.
Prices do not include Lamps, Sockets, or Shades.*

COMBINATION GAS AND ELECTRIC CHANDELIERS.

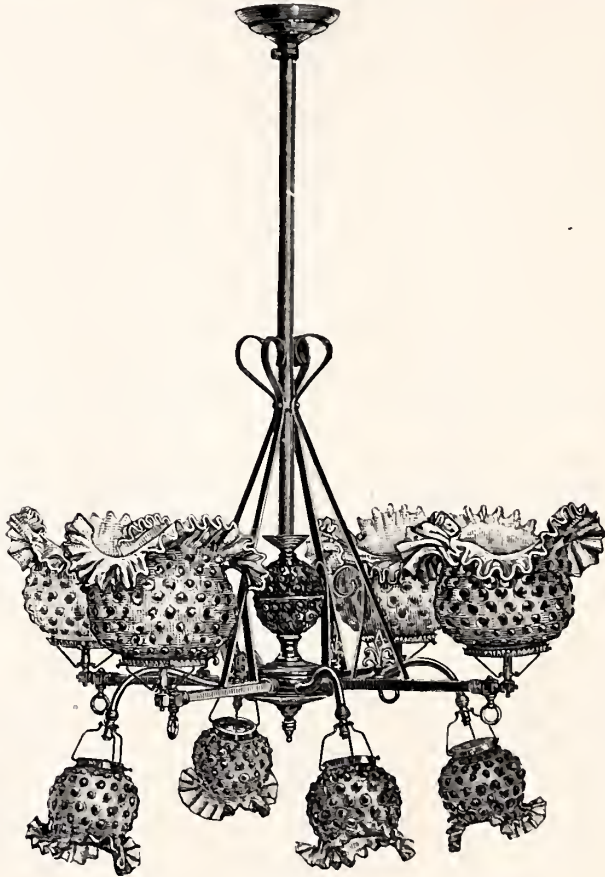

E 768.

FINISHED IN POLISHED BRASS OR GOLD.

Length, 40 in. : spread, 24 in.

4-Light, 2 Gas and 2 Electric : each.....	\$18 75
6 " 3 " " 3 " " "	25 00
8 " 4 " " 4 " " "	31 00
12 " 6 " " 6 " " "	37 00

*Combination Chandeliers have Insulated Joints and are Wired.
Prices do not include Lamps, Sockets, or Shades.*

COMBINATION GAS AND ELECTRIC CHANDELIER.

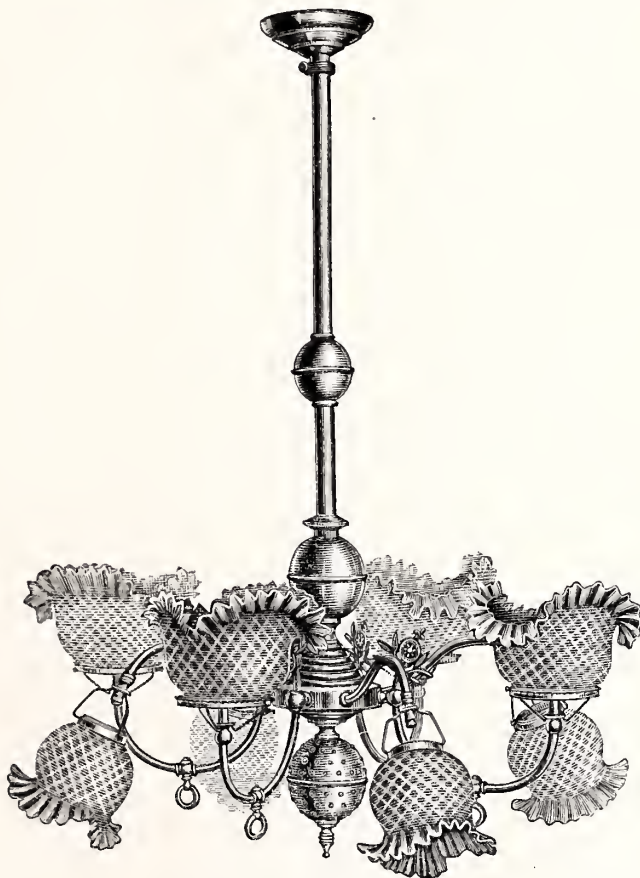

E 769.

FINISHED IN POLISHED BRASS OR GOLD.

Length, 40 in.: spread, 24 in.

4-Light, 2 Gas and 2 Electric: each.....	\$20 00
6 " 3 " 3 " "	26 00
8 " 4 " 4 " "	32 00
12 " 6 " 6 " "	38 00

*Combination Hall Lights have Insulated Joints and are Wired.
Price does not include Lamps, Sockets, or Shades.*

COMBINATION GAS AND ELECTRIC HALL LIGHT.

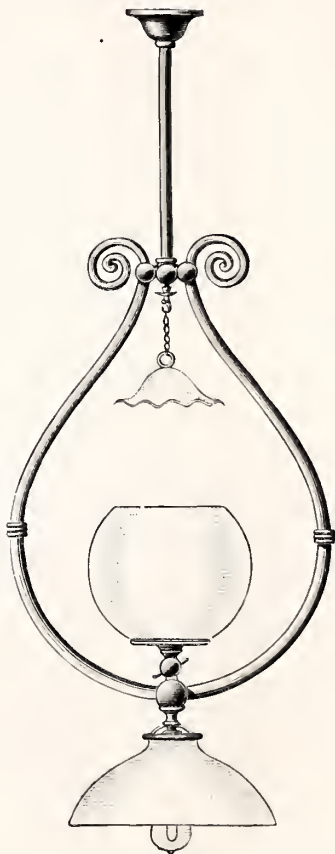

E 770.

FINISHED IN POLISHED BRASS OR GOLD.

Length, 40 in. : spread, 12 in.

Price.....\$15 00

*Combination Chandeliers have Insulated Joints and are Wired.
Prices do not include Lamps, Sockets, or Shades.*

COMBINATION GAS AND ELECTRIC FIXTURE.

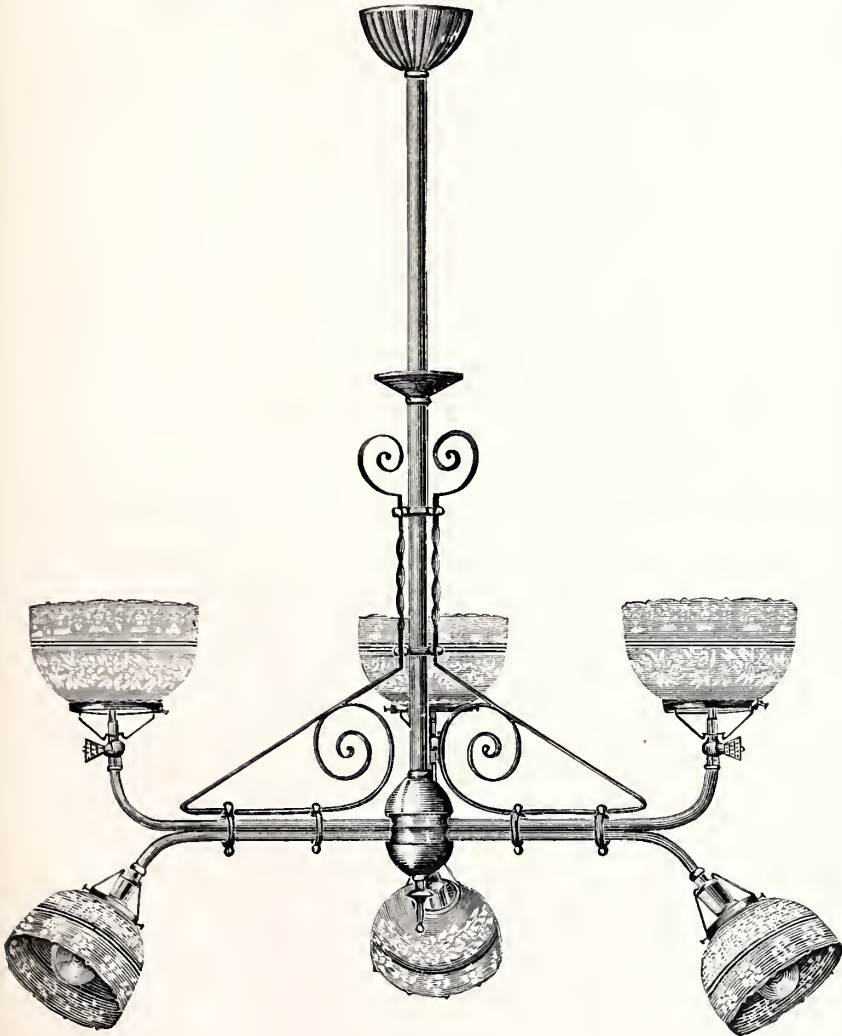

E 771.

Length, 40 in. : spread, 30 in.

4-Light, 2 Gas and 2 Electric; each	\$20 00
6 " 3 " 3 " "	26 25
8 " 4 " 4 " "	32 00

*Combination Chandeliers have Insulated Joints and are Wired.
Prices do not include Lamps, Sockets, or Shades.*

COMBINATION GAS AND ELECTRIC CHANDELIER.

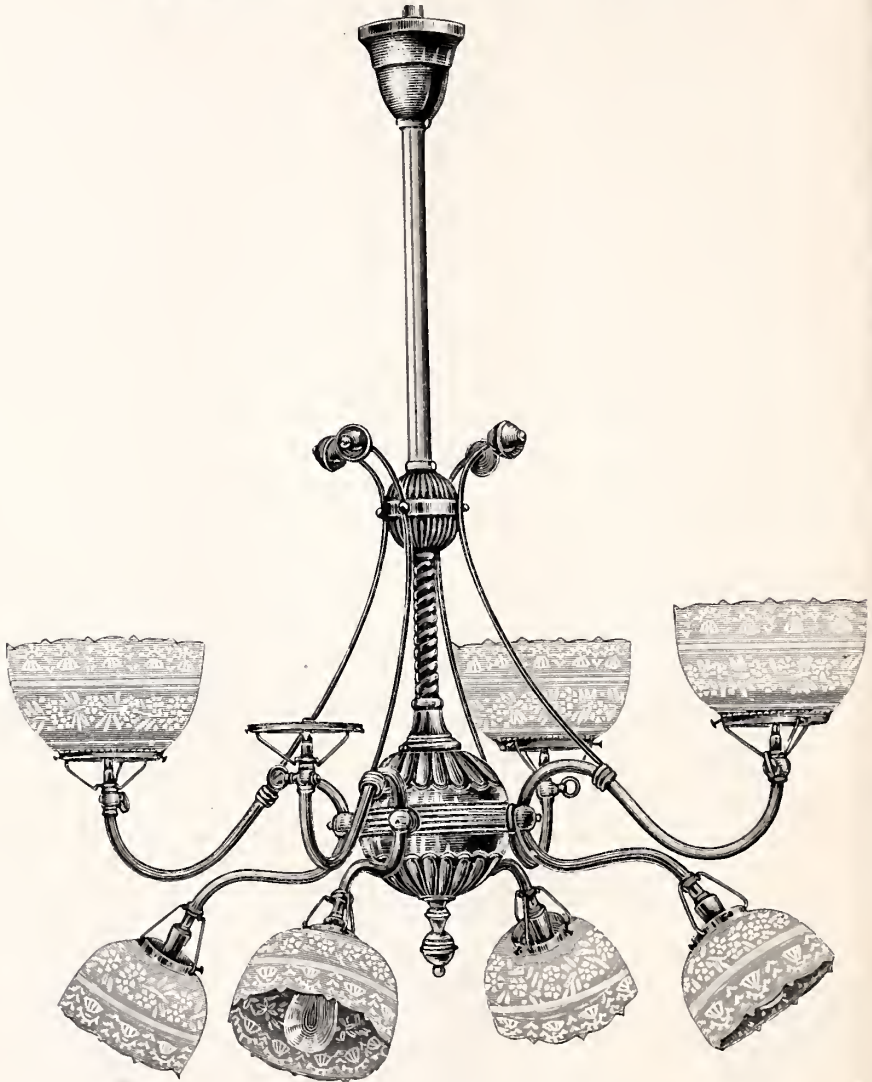

E 772.

FINISHED IN POLISHED BRASS OR GOLD.

Spread, 30 in.; height, 36 in.

4-Light, 2 Gas and 2 Electric; each	\$22 00
6 " 3 " 3 " "	28 25
8 " 4 " 4 " "	34 00
10 " 5 " 5 " "	40 00

*Combination Chandeliers have Insulated Joints and are Wired.
Prices do not include Lamp Sockets of Electric Globes.*

**COMBINATION GAS AND ELECTRIC CHANDELIER WITH SWINGING
GAS ARMS AND PATENT BEACON LIGHTS.**

(We furnish with this fixture Opal Dome Shades for Gas Lights.)

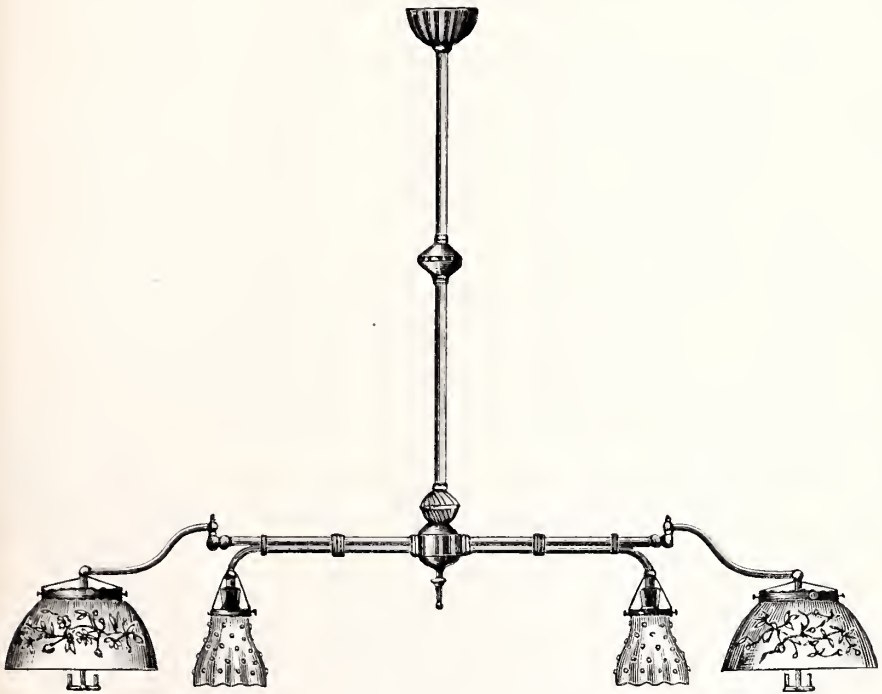

E 773.

FINISHED IN POLISHED BRASS OR GOLD.

Length, 40 in. ; spread, 48 in.

4-Light, 2 Gas and 2 Electric ; each.....	\$20 00
6 " 3 " 3 " " " " ".....	30 00
8 " 4 " 4 " " " " ".....	40 00

*Combination Chandeliers have Insulated Joints and are Wired.
Prices do not include Lamps, Sockets, or Shades.*

COMBINATION GAS AND ELECTRIC CHANDELIER.

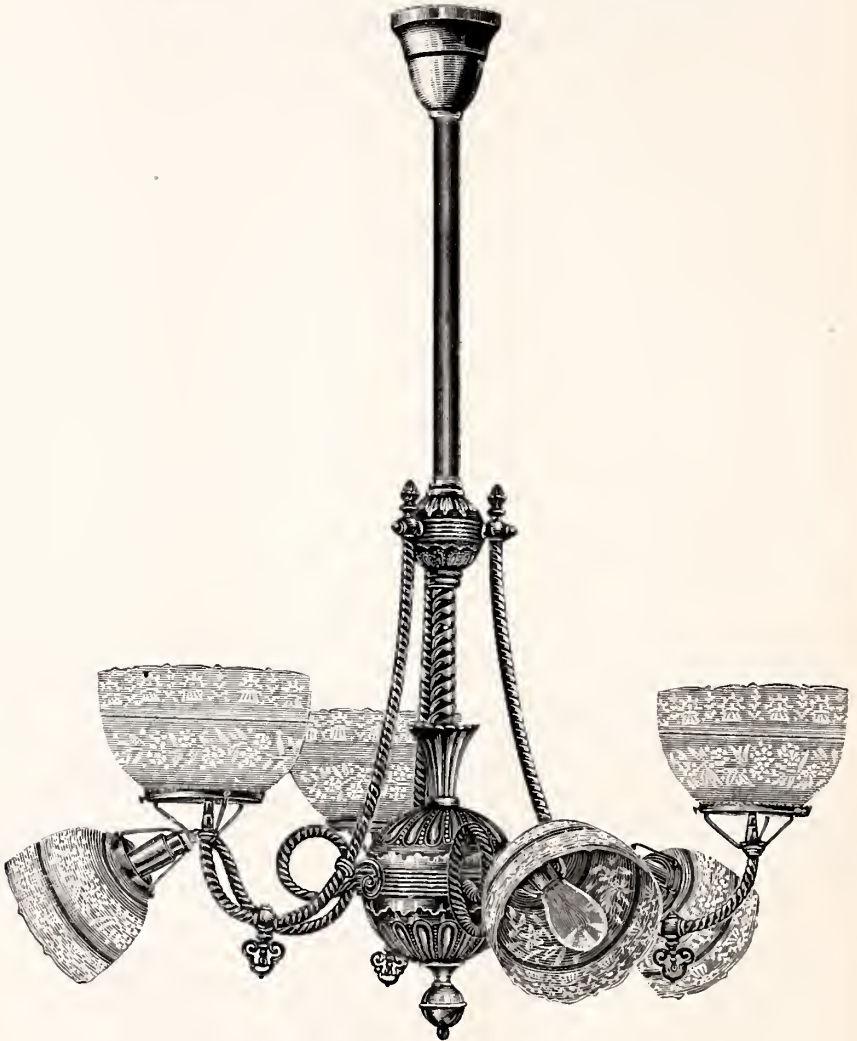

E 774.

FINISHED IN POLISHED BRASS OR GOLD.

Length, 40 in.; spread, 25 in.

4-Light, 2 Gas and 2 Electric; each	\$27 00
6 " 3 " 3 " "	34 50
8 " 4 " 4 " "	42 00
10 " 5 " 5 " "	50 00

*Combination Chandeliers have Insulated Joints and are Wired.
Prices do not include Lamps, Sockets, or Shades.*

COMBINATION GAS AND ELECTRIC CHANDELIER.

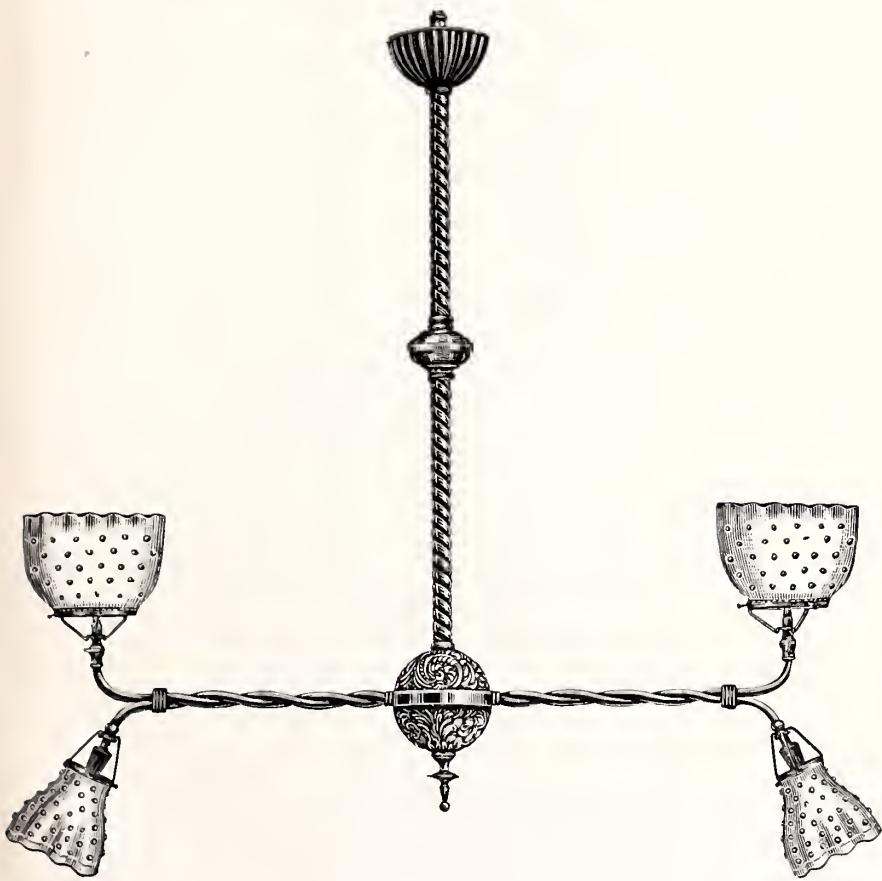

E 775.

FINISHED IN POLISHED BRASS OR GOLD.

Length, 40 in.; spread, 36 in.

4-Light, 2 Gas and 2 Electric; each.....	\$20 00
6 " 3 " " 3 " "	26 25
8 " 4 " " 4 " "	32 00

*Combination Chandeliers have Insulated Joints and are Wired.
Prices do not include Lamps, Sockets, or Shades.*

COMBINATION GAS AND ELECTRIC CHANDELIER.

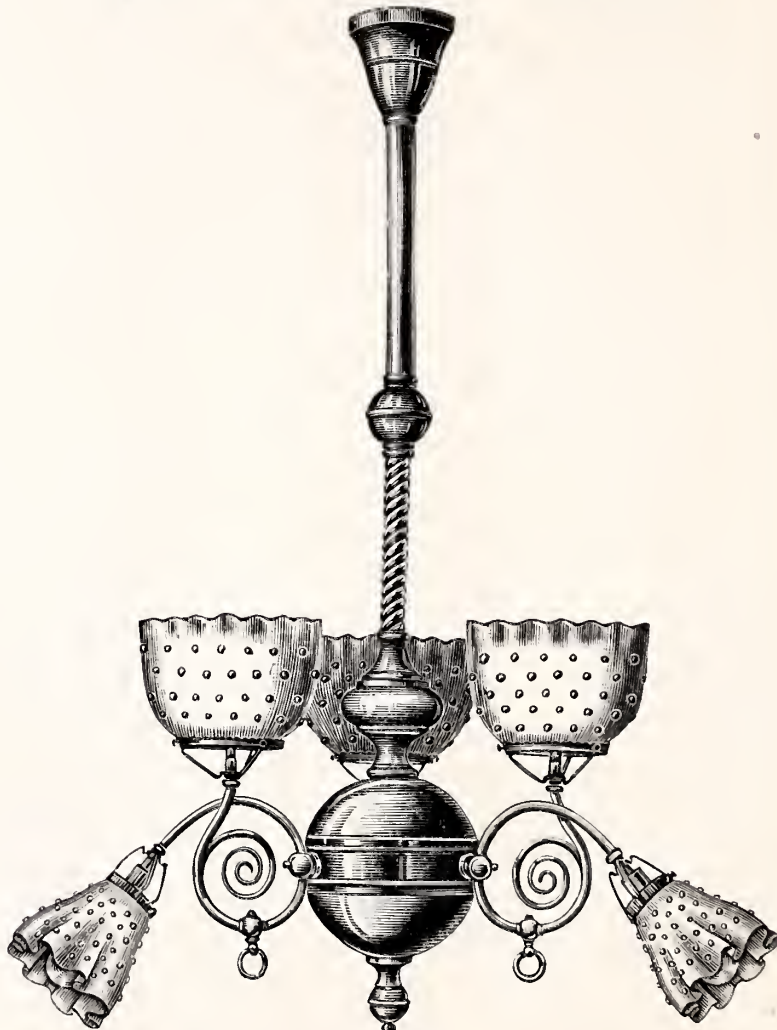

E 776.

FINISHED IN POLISHED BRASS OR GOLD.

Length, 40 in.: spread, 24 in.

4-Light, 2 Gas and 2 Electric: each	\$25 00
6 " 3 " 3 " "	31 25
8 " 4 " 4 " "	37 50

FLAT TIN CORRUGATED SHADE.

Japanned outside. Bright inside.

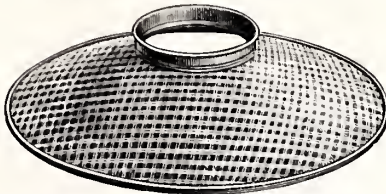

E 800.

For 3 1/4-inch Holder. Can be made to fit any other size Holder.

8-inch diameter, per doz.....	\$5 00
10 " " " "	5 60
12 " " " "	7 50
14 " " " "	11 20

FLAT TIN PAINTED SHADE.

Green outside. White inside.

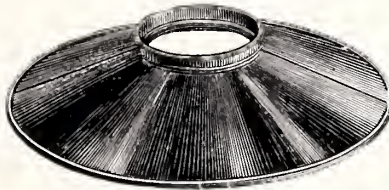

E 801.

For 3 1/4-inch Holder. Can be made to fit any other size Holder.

8-inch diameter, per doz.....	\$5 00
10 " " " "	7 20
12 " " " "	8 70
14 " " " "	12 50

PRINTERS' OR APRON TIN SHADE.

JAPANNED AND CORRUGATED.

Bright inside.

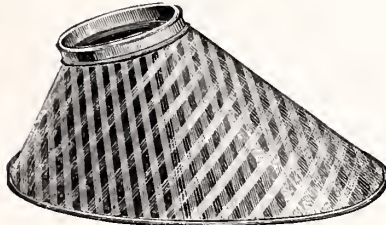

E 802.

10-inch Diameter. 3 1/4-inch Holder. 5 inches Deep.

Can be made to fit any other size Holder.

10-inch, per doz.....	\$7 00
-----------------------	--------

PULPIT HOOD.

FRENCH BRONZE FINISH.

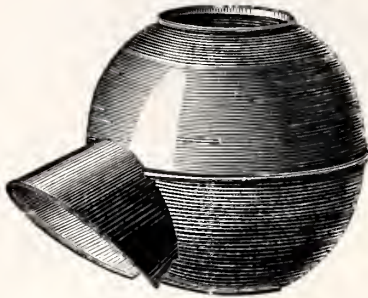

E 803.

8-inch Diameter. 4-inch Holder.

Price, each\$3.00

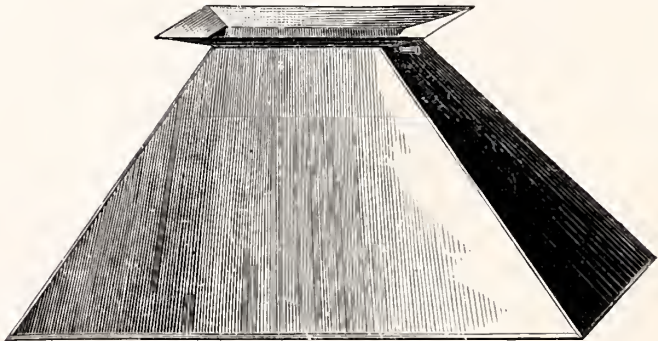
BILLIARD SHADE.

E 804.

Per pair..... 86 75
 Per set (4 to set)..... 13 50

Two or three-light Adjustable Clusters, Figs. E 472 and E 473,
 arranged to fit above Shade.

TIN SHADE.

Painted Green outside. White inside.

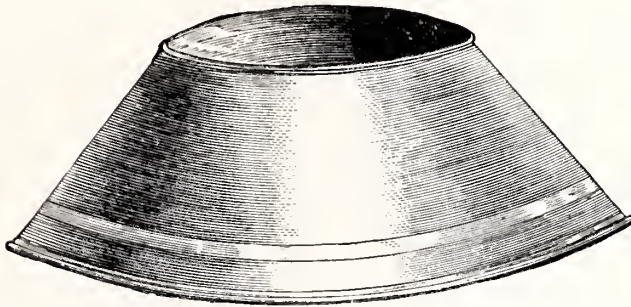

E 805.

10-inch diameter, per doz	\$5 00
12 " " " "	7 50

CORRUGATED TIN SHADE.

JAPANNED.

Bright finish inside.

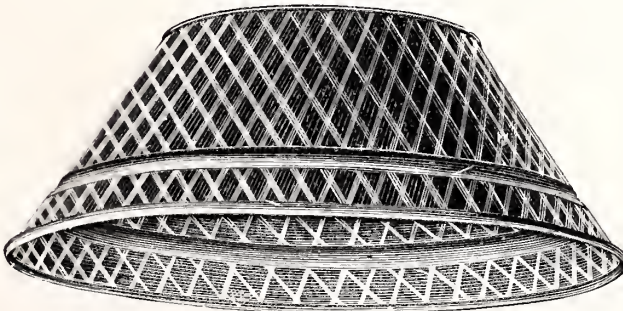

E 806.

10-inch diameter, per doz	\$5 00
12 " " " "	6 50

DEEP TIN CANOPY SHADE.

FOR OUTSIDE PURPOSES.
Japanned outside. Bright inside.

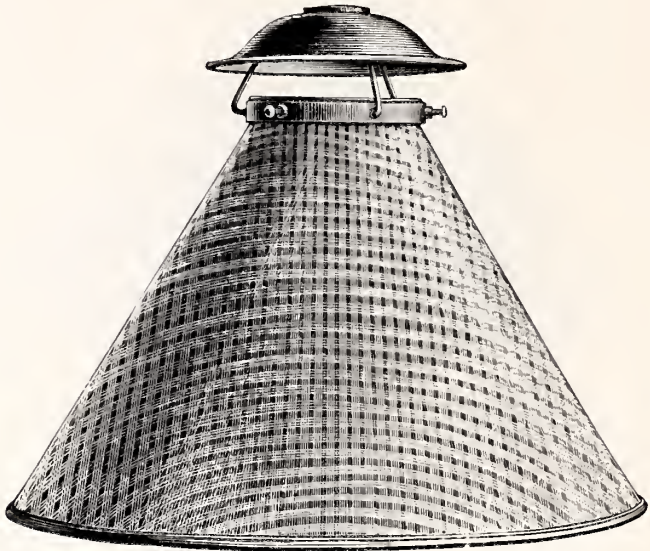

E 807.

12-inch Diameter. 10 inches Deep.

Complete, per doz..... \$22.50

DEEP TIN SHADE.

TO FIT SOCKET.
Japanned outside. Bright inside.

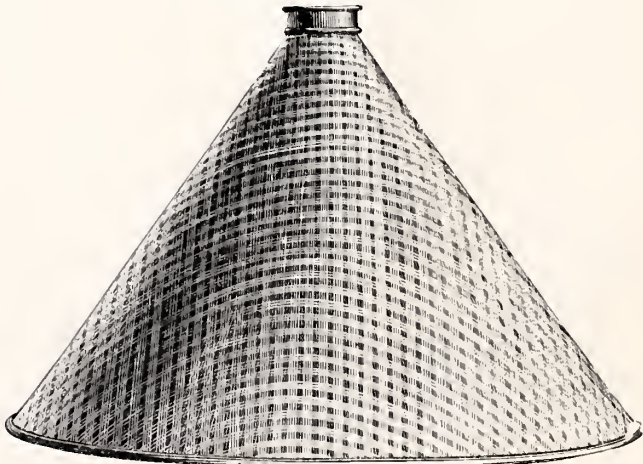

E 808.

12-inch Diameter. 8 inches Deep.

IN ORDERING, PLEASE GIVE SIZE OF OPENING AT TOP OF SHADE.

Per doz..... \$17.50

TIN SCREEN.

TO FIT FLAT PORCELAIN SHADES.

Painted White inside and Green outside.

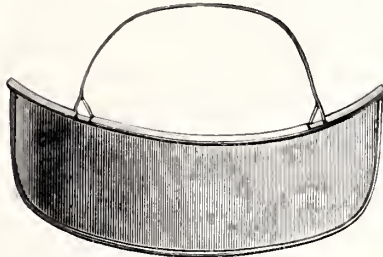

E 809.

Price, per doz.....\$6.00

TIN SCREEN.

TO FIT FLAT METAL SHADES.

Painted White inside and Green outside.

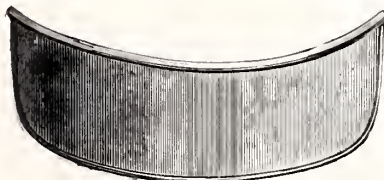

E 810.

Price, per doz.....\$6.00

ENAMELED PAPER SHADE WITH CLAMP HOLDER.

TO FIT FILAMENT LAMP.

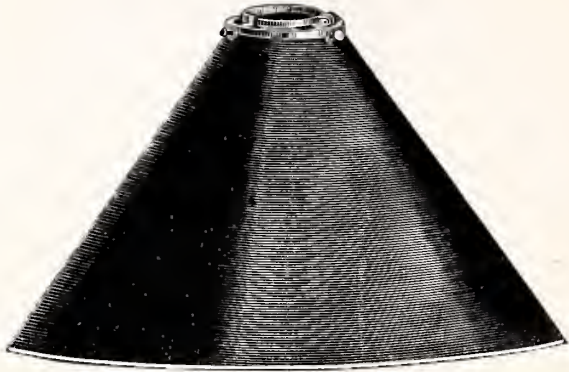

E 811.

Diameter, 10 in. ; Depth, 5 in.

In ordering, state name of Filament Lamp in use.

The above Shade is very desirable for Desk lights, reflecting the light downward and preventing rays from striking the eye.

Price, per hundred, including Holder.....\$45.00

TINNED WIRE HINGE GUARD.

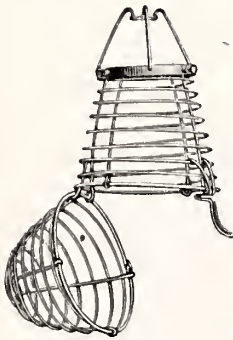

E 900.

Diameter, 4½ in.

Height, 7 in.

Holder, ¾ in.

Price, per doz., complete with holder.....\$17 25
 Price, per doz., less holder..... 15 00

TINNED WIRE HINGE GLOBE.



E 901.

Diameter, 7 in.

Height, 6 in.

Holder, ¾ in.

Price, per doz., complete with holder.....\$19 75
 Price, per doz., less holder. 17 50

TINNED WIRE GUARD.

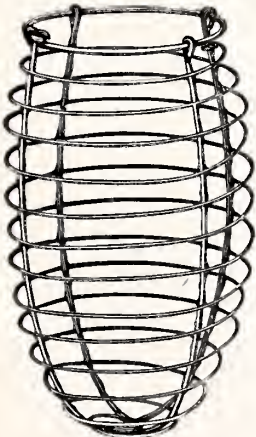

E 902.

Diameter, 4½ in.

Height, 7 in.

Holder, ¾ in.

Price, per doz.....\$7.50

TINNED WIRE VERTICAL GUARD.

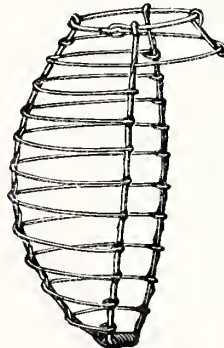

E 903.

Diameter, 3½ in

Height, 6 in.

Holder, ¼ in.

Price, per doz.....\$10.00

WIRE GUARD.

FOR FOOT-LIGHT SCREENS.

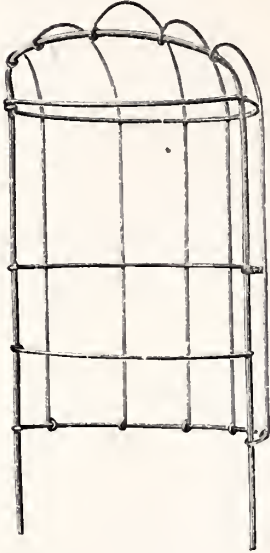

E 901.

5½ in. x 11 in. Per doz. \$10.00

TIN FOOT-LIGHT SCREEN.

Painted White inside.
Green outside.



E 904½.

5 in. x 11 in. Per doz. \$6.00

GAS-FITTERS' CEMENT.



E 905.

Price, per pound. 20 cents.

COVERING TUBE.

POLISHED BRONZE OR BRASS. (All Sizes.)

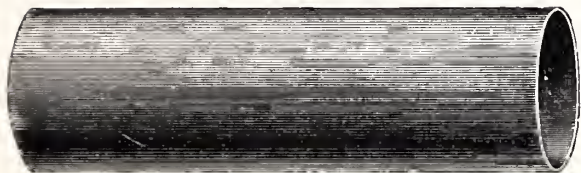

E 906.

$\frac{3}{4}$ -inch covers $\frac{3}{8}$ -inch iron pipe.
 $1\frac{1}{8}$ -inch covers $1\frac{1}{2}$ -inch iron pipe.
 $1\frac{1}{4}$ -inch covers $\frac{3}{4}$ -inch iron pipe.

Price, per pound.....\$1.50

TAPS.

BRASS THREAD.

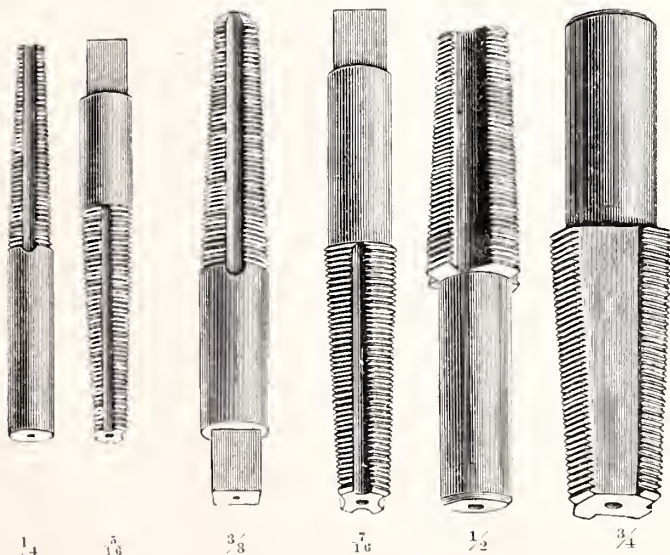

E 907.

$\frac{1}{4}$, $\frac{1}{2}$, $\frac{5}{16}$, $\frac{3}{8}$, each.....\$1 50
 $\frac{7}{16}$, $\frac{1}{2}$, $\frac{3}{4}$, $\frac{7}{8}$, each..... 2 00

ADJUSTABLE GAS PLYERS.

WITH WIRE-CUTTER AND SCREW-DRIVER.

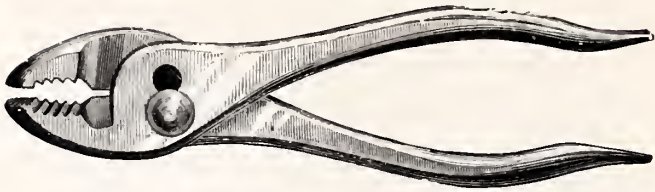

E 908.

Black, per doz \$33 75
 Polished, “ 37 50

GAS PLYERS.

6 inch. 7-inch. 7½-inch. 8-inch. 9-inch. 10-inch. 11-inch. 12-inch.

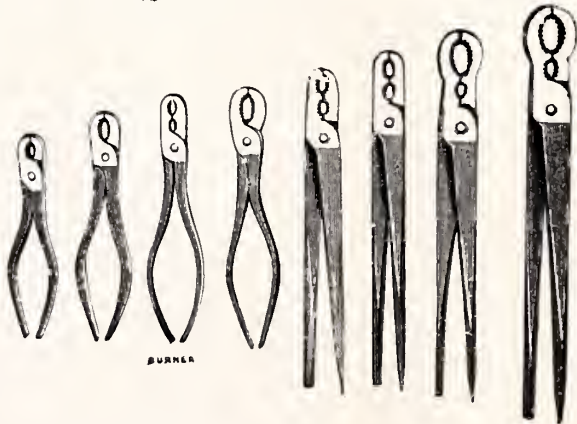

E 909.

STEEL GAS PLYERS.

No. 0.	No. 1.	Burner.	No. 2.	No. 3.	No. 4.	No. 5.	No. 6.
1 Pair.	1 Pair.	1 Pair.	1 Pair.	1 Pair.	1 Pair.	1 Pair.	1 Pair.
\$1.00	\$1.20	\$1.80	\$1.50	\$1.80	\$2.20	\$2.50	\$3.00

Polished, \$2.00 per dozen extra.

CARBON PLYERS.

FOR 'TRIMMERS' USE.

Steel Plyers for handling Arc Lamp Carbons.

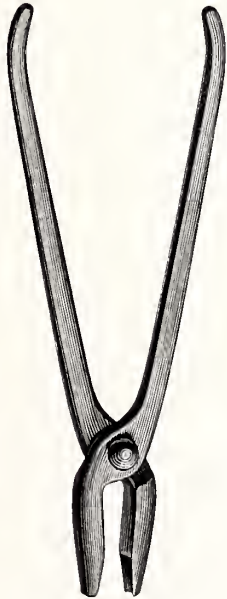

E 90996.

Length, 8 inches.

Price, per doz. \$10.00

**GLEASON'S IMPROVED GAS-FIT-
TERS' ALCOHOL TORCH.**

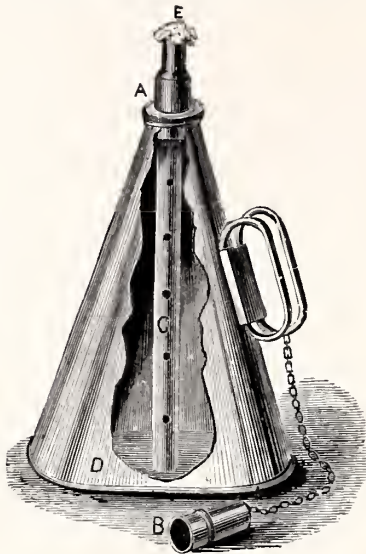

E 910.

**GALLOWAY'S TIN GAS-FITTERS'
TORCH AND BLOW-PIPE
COMBINED.**

PATENT.

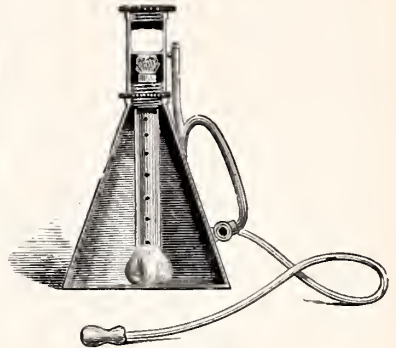

E 910 1/4.

Brass, per doz. \$24.00 | Tin, per doz. \$20.00 | Per doz. \$36.00

No. 185.

PRISMS.

No. 130.



E 911.

Prices on Prisms subject to change without notice.

No. 185	2 1/2-in.	3-in.	3 1/2-in.	4-in.					
Per hundred.	\$6.00	\$7.00	\$8.00	\$10.00					
No. 130.	2 1/2-in.	3-in.	3 1/2-in.	4-in.	4 1/2-in.	5-in.	6-in.	7-in.	8-in.
Per hundred.	\$6.00	\$7.00	\$8.00	\$9.00	\$10.00	\$12.00	\$14.00	\$16.00	\$20.00

LINEMEN'S STRIP SOLDER.

FOR SOLDERING JOINTS.



E 912.

Put up in 5-pound packages.

Price, per pound.....\$1.00

LINEMEN'S SOLDERING SALTS.



E 913.

$\frac{1}{2}$ -pound bottle, each.....\$1.25

1 " " " ".....2.50

BINDING TAPE.



E 914.

B. F. G. Tape, red, white, or black, per pound.....	\$1 20
Grimshaw Tape, white, "	1 60
" " black, "	1 60
Okanite, " black, per roll.	2 50
Keyrite, " " "	1 75

RUBBER TUBING.

$\frac{1}{4}$, $\frac{3}{8}$ and $\frac{1}{2}$ -inch.

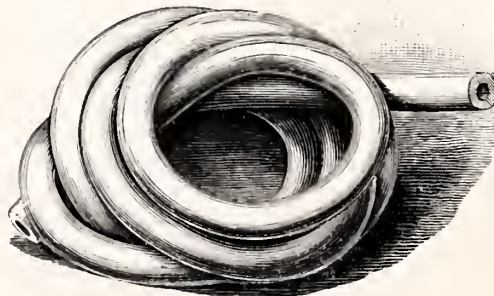

E 915.

Cloth-inserted, 1 cr foot.....	$\frac{1}{4}$ -inch, 20c.	$\frac{3}{8}$ -inch, 25c.	$\frac{1}{2}$ -inch, 35c.
Plain Rubber, "	" 20c.	" 25c.	" 35c.

RUBBER COVER FOR KEYLESS SOCKETS.



E 916

The above cut represents our Pure India Rubber Cover as used on Keyless Lamp Sockets for outside purposes or damp places in-doors. Prevents corroding or rusting the mechanical part of the Socket, also making the Incandescent Lamp steam or vapor proof.

Per dozen.....\$2.50

COPPER WIRE SCREEN FOR ARC LAMP GLOBES.

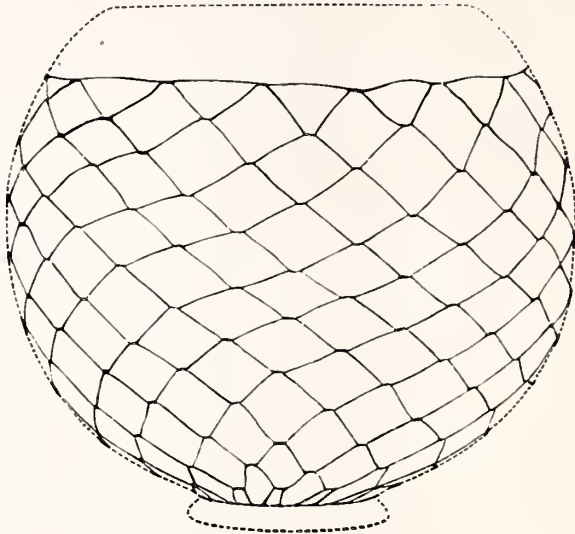

E 917.

5 meshes: length, 14 in. ; width, 10 in.

Per dozen.....\$4.50

Used in compliance with the requirements of the Board of Fire Underwriters. In case of breakage of the Arc Lamp Globe, when in position, it prevents fragments of glass falling, securely holding the broken globe together until such time as it can be replaced.

DOUBLE-POLE FUSIBLE CUT OUT.

FOR CORD PENDANTS.

With Removable Cover.



E 918.

Per doz.....\$7.50

FLEXIBLE HANDLE LINEMEN'S TORCH.

PATENTED.

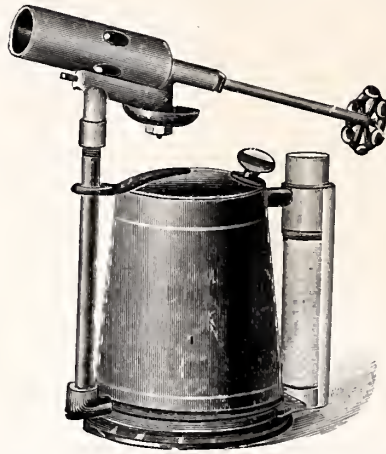

E 919.

This Burner has no inside works to get out of order. The handle is flexible, being made of rubber tubing, shielded with a thin sheet of metal, to afford stability. The valves are small rubber plugs, in the top and bottom, easily unscrewed. A powerful pressure is produced by squeezing the handle. A few quick motions will produce a well-developed blue flame from the mouth of the Burner.

Price, each.....\$11.25

GASOLINE SOLDERING FURNACE.

FOR TELEGRAPH LINE WORK.

Superior to charcoal, more convenient and economical, and perfectly safe.

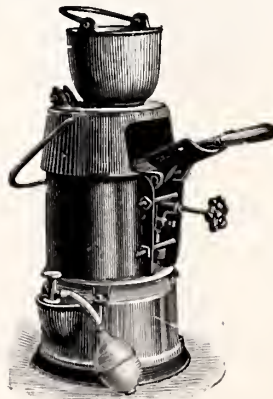

E 920.

Each.....\$11.25

PORCELAIN INSULATORS.—FULL SIZE CUTS.

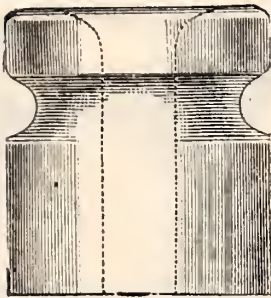

E 921.

Insulator, $1\frac{5}{8} \times 1\frac{5}{8}$ in., Regular Size.
(Round Top.)

Per 1,000.....\$25.00

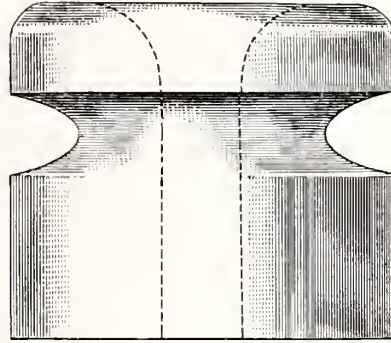

E 922.

Insulator, $1\frac{3}{4} \times 2$ in., Large Size.
(Round Top.)

Per 1,000.....\$45.00

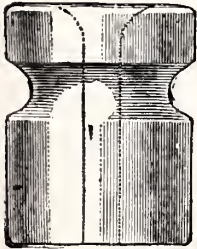

E 923.

Insulator, $1\frac{1}{4} \times 1$ in.

Per 1,000.....\$20.00



E 924.

Insulator, $1\frac{1}{4} \times \frac{5}{8}$ in.

Per 1,000.....\$25.00

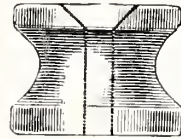

E 925.

Insulator, $\frac{5}{8} \times \frac{7}{8}$ in.
(Small Spool.)

Per 1,000.....\$16.25

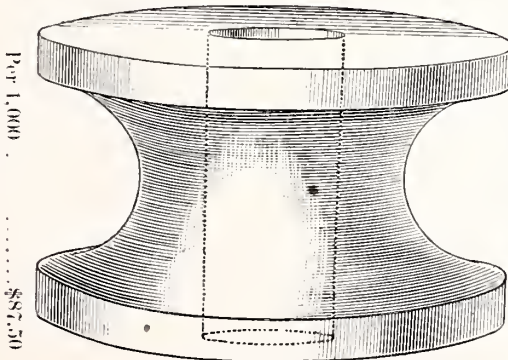

Per 1,000

.....\$7.50

Insulator, $1\frac{1}{2} \times 2\frac{1}{2}$ in.
(Large Spool.)

E 926.

· PORCELAIN INSULATORS.

FULL SIZE CUTS.

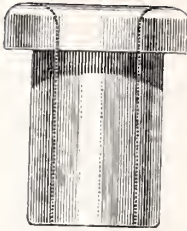

E 927.

(Large.)

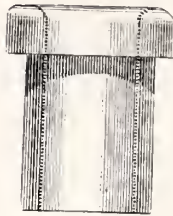

E 928.

(Small.)

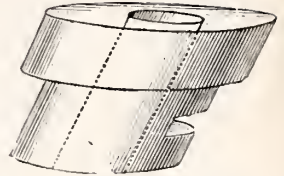

E 929.

Porcelain Bushings or Conveyers.

Price, per 1,000 . . . \$40.00

Porcelain Switch Bushings.

Price, per 1,000 . . . \$180.00

PORCELAIN CLEATS.

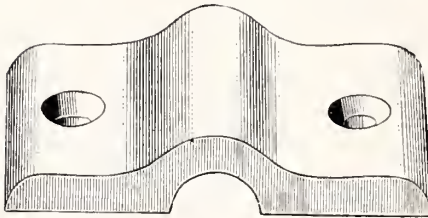

E 930.

2 1/4 in. long, 1 in. wide.

Per 1,000 \$28.75

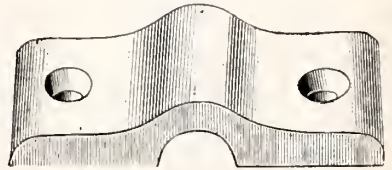

E 931.

2 in. long, 1 in. wide.

Per 1,000 \$24.00

Porcelain Half-Cleat.

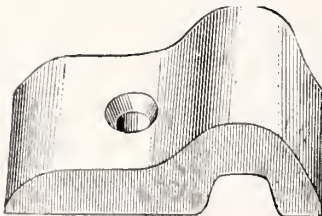

E 932.

Per 1,000 \$24.00

CIRCUIT BREAKER.

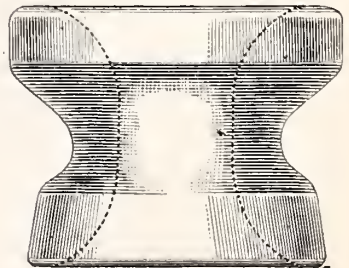

E 933.

Per 1,000 \$52.50

PORCELAIN INSULATORS.

FULL SIZE CUTS.

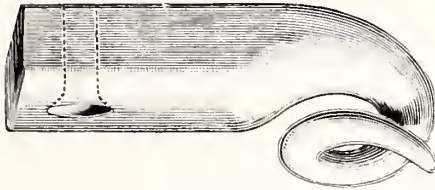

E 934.

Porcelain Pigtail Hook.

Per 1,000.....\$220.00

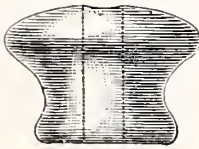

E 935.

1-inch Porcelain Plain Knobs.

Per 1,000....\$12.00

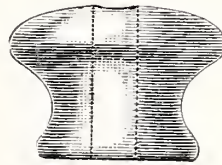

E 936.

1 1/8-inch Porcelain Knobs.

Per 1,000 .. \$13.50

INSULATED WIRE, SUITABLE FOR WIRING GAS FIXTURES AND ELECTROLIERS.

Special Duplex Fixture Wire.

Can be used in any size pipe. Protected from all mechanical injury to insulation while placing in position.



E 937.

No. 18 B. & S., per foot	8 cents.
" 16 " " " " " "	9 "
" 14 " " " " " "	10 "



E 938.

No. 14 B. & S. Gauge.

Price, per pound . . . \$1.00

Patent Duplex Electrolier Wire.



No 14 B. & S. Gauge.

Price, per pound, \$1.00

E 939.

INCANDESCENT LAMP CORD.

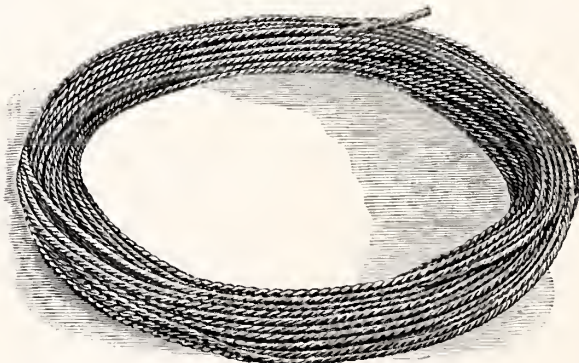

E 941.

SILK.		
No. 16 B. & S., per yard		30 cents.
" 18 " " " " " "		25 "
" 20 " " " " " "		20 "
" 22 " " " " " "		20 "
COTTON.		
No. 16 B. & S., per yard		25 cents.
" 18 " " " " " "		20 "
" 20 " " " " " "		13 "
" 22 " " " " " "		13 "

VAPOR-PROOF GLOBE.

WITH BRASS SCREW CAP COMPLETE, READY FOR USE, WITHOUT SOCKET.

Patent pending.

$\frac{3}{8}$ Iron Pipe.



E 942.

Our improved Vapor-proof Globe is constructed with a view to relieve the pressure which exists between the globe and lamp when the air is expanded by the heat from the lamp.

In the common globes there is no vent to let off this extra pressure, hence many globes and lamps are broken.

Our cover is provided with a vent which opens by *internal* pressure, but which is tightly closed against water, steam, vapor or any pressure *from without*.

No matter how hot the lamp runs there is never any extra pressure on the glass.

Diameter, 6-in.	Height, 8½ in.	No. 1, per doz.....	\$24 00
“ 9-in.	“ 13 in.	“ 2, “ “	50 00

MAGNETO BELL.

FOR TESTING ELECTRIC LIGHT CIRCUITS.

A valuable instrument for detecting grounds in Combination and Electric Fixtures.

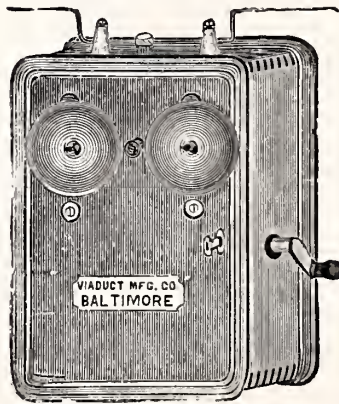

E 943.

10000 Ohmes resistance.

Price, each.....\$15.00

OPAL REFLECTOR FOR INCANDESCENT LIGHTING.



E 249.

22-in. diam.; length, 40 in.; incldg. Wiring, 3-Lt. Cluster, less Lamps or Sockets, \$19 00										
25	"	"	"	40	"	"	4	"	"	22 50
30	"	"	"	40	"	"	6	"	"	30 00
35	"	"	"	40	"	"	8	"	"	37 50
40	"	"	"	40	"	"	10	"	"	45 00

BEACON INCANDESCENT ELECTRIC PENDANT.

With 14-inch Decorated Dome Shade, Band and Prisms. 10-inch Opal Deflector.
Including Canopy, Insulated Joint and Wiring. *Patented May 3, '87, and May 8, '88.*

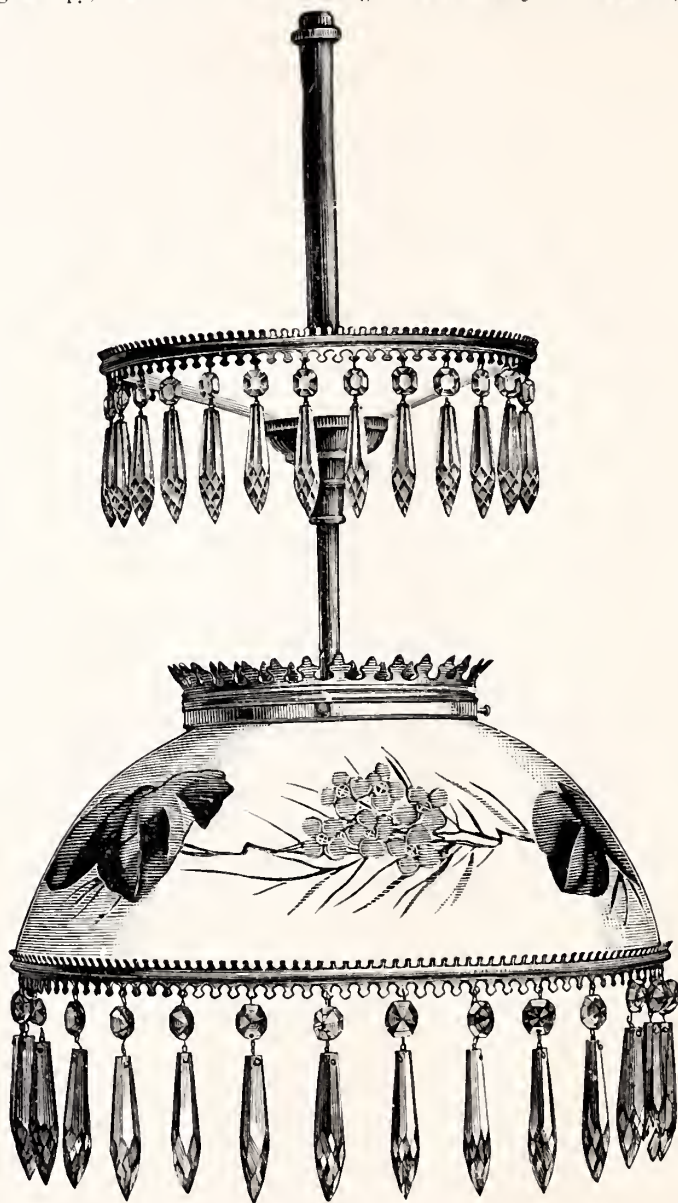

E 250.

Price complete, less Cluster or Sockets. Length, 30 in. Each, \$11.50
Adjustable Clusters, Figs. E 472 and E 473, from Two to Six-Light, can be attached to
above Pendant.

BEACON INCANDESCENT PENDANT.

With 14-inch Opal Dome Shade. 10-inch Opal Deflector.
Including Wiring, Insulated Joint and Canopy.

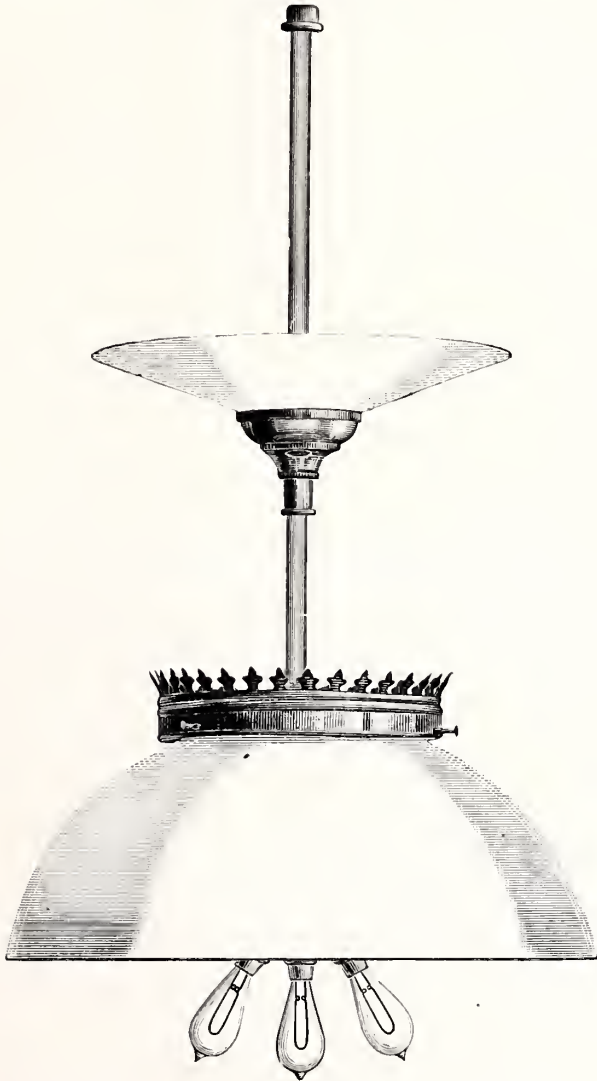

E 251

Length, 30 in.

Price complete, less Cluster or Lamps. Each \$6.00

Adjustable Clusters, Figs. E 472 and E 473, from Two to Six-Light, can be attached to above Pendant.

OBLONG WINDOW REFLECTOR.

SILVERED GLASS. SQUARE END. ARRANGED FOR ANY SYSTEM.

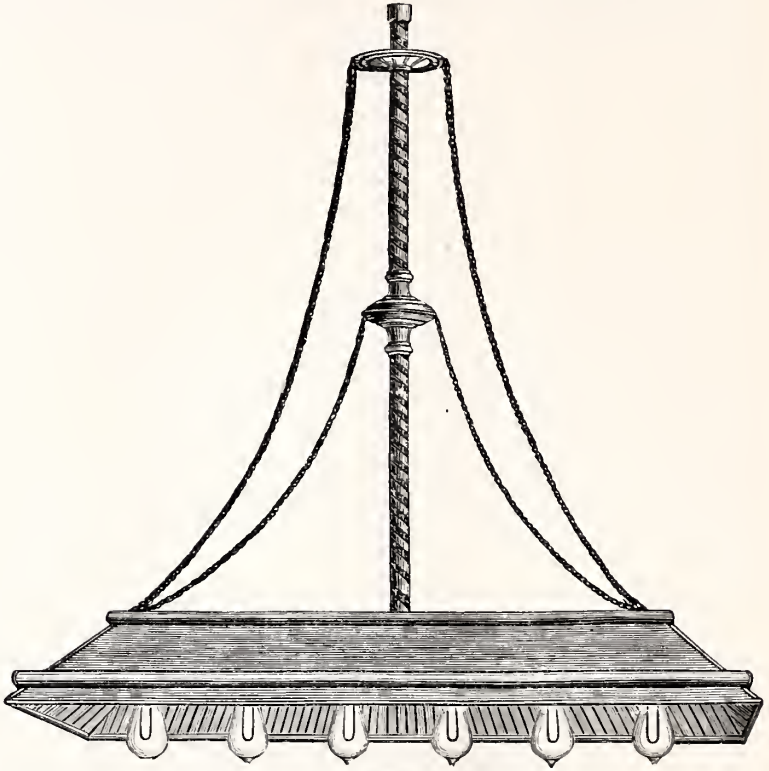

E 252.

24-inch. 2-Light, less Sockets, each.....	\$13 00	48-inch. 6 Light, less Sockets, each.....	\$22 20
30 " 4 " " " " ".....	15 00	54 " 8 " " " " ".....	24 00
36 " 6 " " " " ".....	18 00	60 " 8 " " " " ".....	30 00
42 " 6 " " " " ".....	20 00		

ADJUSTABLE PRISM BAND.

FOR DECORATING CONE OR DOME SHADES.

Patented May 3, 1887, and May 8, 1888.



E 253.

See Fig. 254.

[FINISHED IN POLISHED BRASS OR GOLD.

10-inch, per doz.	\$12 00	14-inch, per doz.	\$15 00
------------------------	---------	------------------------	---------

OPAL REFLECTOR, FOR SUSPENDING.

10-inch Diameter. 2 1/4 or 3 1/4-inch Holder, with Adjustable Bands and Crystal Prisms.

Patented May 3, 1887, and May 8, 1888.



E 251.

Price, each, complete.....\$3.50

NICKEL-PLATED & SILVERED GLASS REFLECTORS.

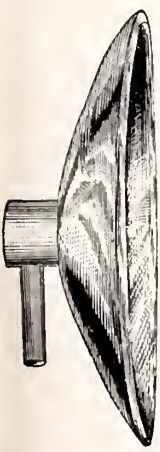

CONCAVE SIDE REFLECTOR.

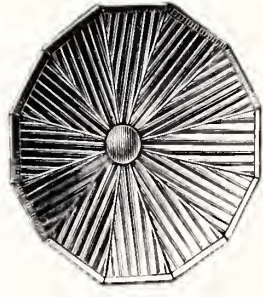

E 255.

E 256.

Silvered Glass Reflectors.

4-inch, per doz.	\$4 00	11 inch, per doz.	\$10 75
5 " " "	4 25	12 " " "	12 50
6 " " "	5 00	14 " " "	36 00
7 " " "	6 00	15 " " "	48 00
8 " " "	7 00	16 " " "	60 00
9 " " "	8 00	17 " " "	72 00
10 " " "	9 25	18 " " "	84 00

Nickel-plated Reflectors.

5-inch, per doz.	\$13 00
6 " " "	14 00
7 " " "	15 00
8 " " "	18 00
9 " " "	24 00
10 " " "	30 00
12 " " "	36 00

6 inch, each	\$0 60
7 " " "	0 90
8 " " "	1 25
9 " " "	1 50
10 " " "	1 75
11 " " "	2 00
12 " " "	2 50

CORRUGATED SILVERED GLASS REFLECTOR.

Can be made to fit the Socket of any Filament Lamp.

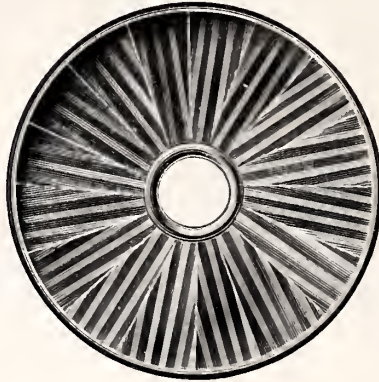

E 257.

10-in. diameter, each.....\$3.00

In ordering Reflectors to fit Sockets of Filament Lamps, state system or name of Filament Lamp in use.

SILVER-PLATED MIRROR REFLECTORS.

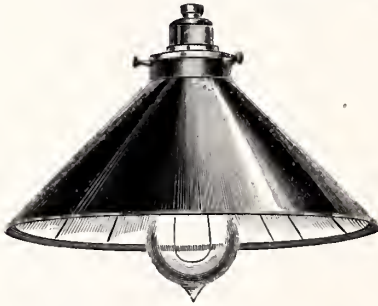

E 258.

Deep Cone Mirror Reflector.

10-in. and 12-in. diameter; 2 1/4 and 3 1/4 Collar; used on Holder

E 404 1/2, page 3.

10-in. diameter, each\$2 90
12 " " " 3 00

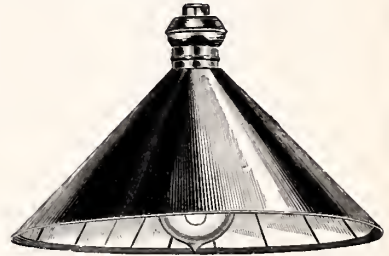

E 259.

Deep Cone Mirror Reflector.

Can be made to fit the Socket of any Filament Lamp.

10-in. diameter, each.....\$2 90
12 " " " 3 00

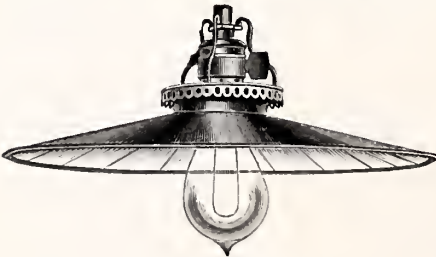

E 260.

Flat Cone Mirror Reflector.

10-in., 12-in. and 14-in. diameter; 2 1/4 and 3 1/4 Collar.

10-in. diameter, each.....\$2 50
12 " " " 2 90
14 " " " 3 10



E 261.

Mirror Reflector for Railway Car Lighting.

Price, each.....\$5.00

In ordering Reflectors to fit Shade Holders, state size of Holder they are to fit.

SLIDING FINISHING SHELL, OR CANOPY.

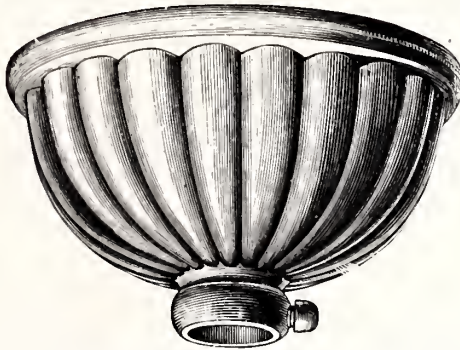

E 325.

FINISHED IN POLISHED BRASS OR GOLD Covering Tripods and Insulated Joints.

3-in. diameter, for	$\frac{1}{8}$ to $\frac{3}{8}$ Iron Pipe, or $\frac{3}{8}$ to $\frac{3}{4}$ Brass Tube; per doz.....	\$6 90
4 "	" " $\frac{1}{2}$ to $\frac{1}{2}$ " " $\frac{3}{4}$ to $\frac{3}{4}$ " "	10 00
5 "	" " $\frac{3}{8}$ to $\frac{3}{4}$ " " $\frac{3}{8}$ to 1 " "	15 00
6 "	" " $\frac{3}{8}$ to 1 " " $\frac{3}{8}$ to $1\frac{1}{2}$ " "	20 00

In ordering, state size of Pipe, whether of Brass or Iron, which it is to slide over.

SLIDING FINISHING SHELL, OR CANOPY.

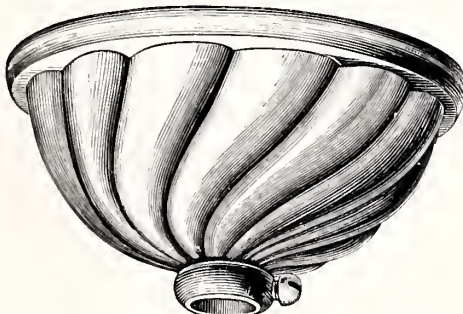

E 326.

FINISHED IN POLISHED BRASS OR GOLD. 3-inch Diameter. Covering Tripods and Insulated Joints.

3-inch diameter, for	$\frac{1}{8}$ to $\frac{3}{8}$ Iron Pipe, or $\frac{3}{8}$ to $\frac{3}{4}$ Brass Tube; per doz.....	\$6.90
----------------------	--	--------

SLIDING FINISHING SHELL, OR CANOPY.

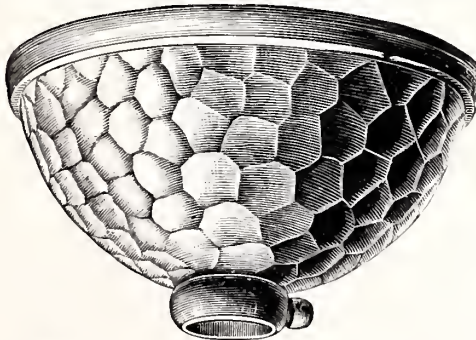

E 327.

FINISHED IN POLISHED BRASS OR GOLD. 3-inch Diameter. Covering Tripods and Insulated Joints.

3-inch diameter, for	$\frac{1}{8}$ to $\frac{3}{8}$ Iron Pipe, or $\frac{3}{8}$ to $\frac{3}{4}$ Brass Tube; per doz.....	\$6.90
----------------------	--	--------

In ordering, please give the size of Tubing or Pipes the Canopy slides on, and whether of Brass or Iron.

BRACKET BACK.

STRUCK.



E 328.

FINISHED IN POLISHED BRASS OR GOLD.

2½-inch, per gross	\$4 50
3 " " "	6 75
4 " " "	11 25

BRACKET BACK.

RIBBED.

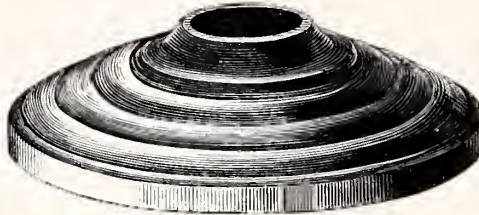

E 329.

FINISHED IN POLISHED BRASS OR GOLD.

2½-inch, per gross	\$5 60
3 " " "	7 85
4 " " "	11 25

SPUN FINISHERS, OR SEATING RINGS.

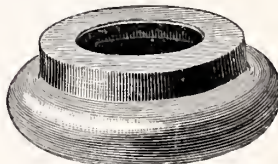

E 330.

FINISHED IN POLISHED BRASS OR GOLD.

¾-inch, per doz	40 cents.
7/8 " " "	40 " "
1 " " "	50 " "
1¼ " " "	60 " "

SEPARABLE FINISHING CANOPY.

For covering Insulated Joints and Cut Outs on fixtures where Sliding Canopy cannot be used.

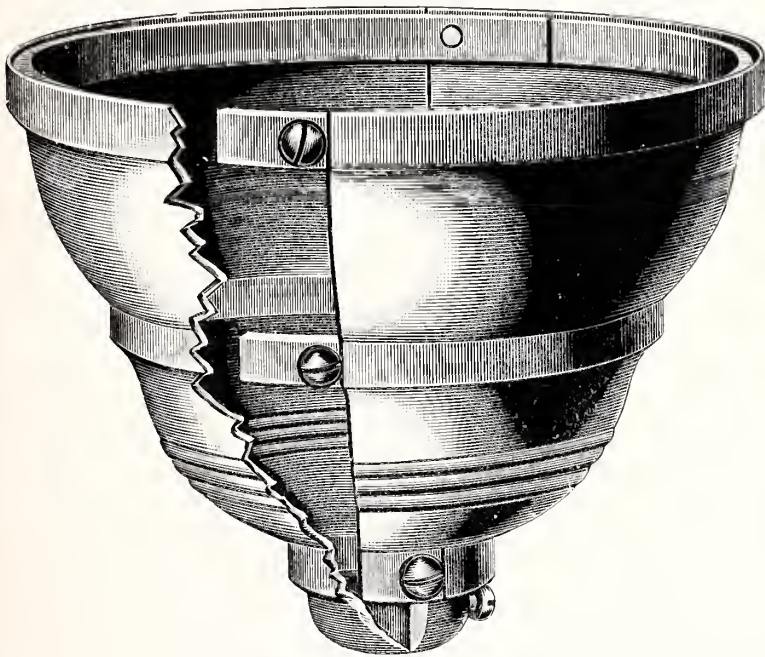

E 331.

5-in. Diameter ; 5 in. Deep.

FINISHED IN POLISHED BRONZE OR BRASS.

Price, each \$4.00

In ordering, give SIZE OF PIPE Shell is to fit, and whether of Brass or Iron.

SEPARABLE FINISHING AND SLIDING CANOPY.

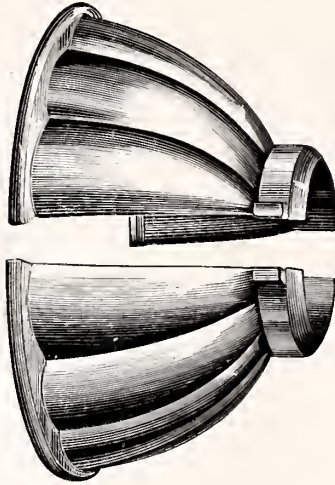

E 332.

FINISHED IN POLISHED BRASS OR GOLD.

Covering Tripods and Insulated Joints.

						Per doz.
3-in. diameter, for	$\frac{1}{8}$ to $\frac{3}{8}$	Iron Pipe, or	$\frac{3}{8}$ to $\frac{3}{4}$	Brass Tube...		\$14 00
4 " " "	$\frac{1}{8}$ to $\frac{1}{2}$	" "	$\frac{3}{8}$ to $\frac{3}{4}$	" ...		20 00
5 " " "	$\frac{3}{8}$ to $\frac{3}{4}$	" "	$\frac{3}{8}$ to $\frac{3}{4}$	" ...		30 00
6 " " "	$\frac{3}{8}$ to 1	" "	$\frac{3}{8}$ to $\frac{3}{4}$	" ...		40 00

In ordering, state SIZE OF PIPE, whether of Brass or Iron, which it is to slide over.

INCANDESCENT ELECTRIC LAMP (Vitrite Patent),
FOR ANY SYSTEM.

Cut shows the exact size of Lamp and Socket, with Switch.

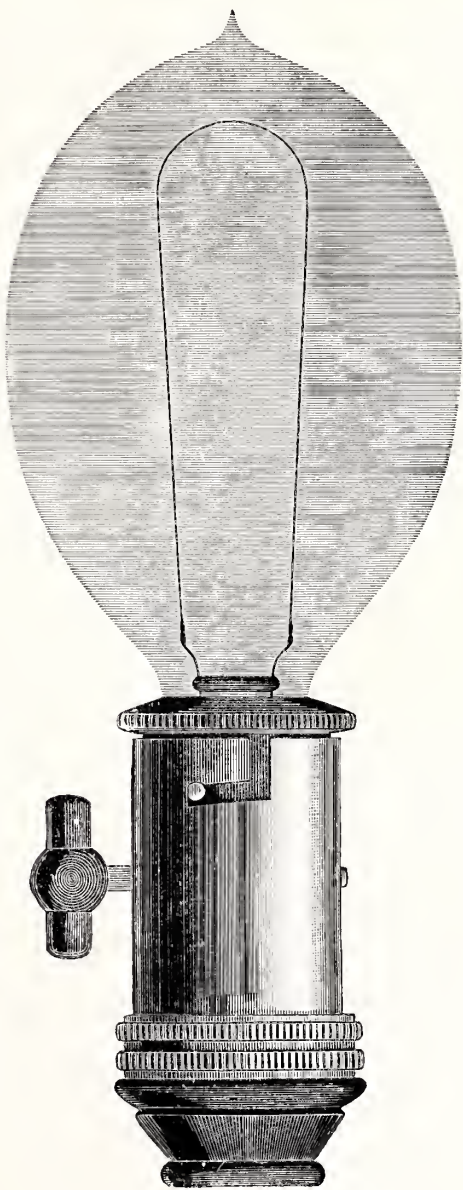

The Glass Bulb is exact size of all Bulbs from 60 to 110
 Volts, inclusive (16 or 20 Candle-power).

E 1250.

Price, complete, with Key Socket, as shown, each.....	\$3 38	Keyless Sockets only, each	\$1 14
Complete, with Keyless Socket, each.....	2 63	Standard Lamps or Bulbs, with or without cap, each.....	1 50
Key Sockets only, each.....	1 88		

WESTINGHOUSE LAMP AND KEY SOCKET.

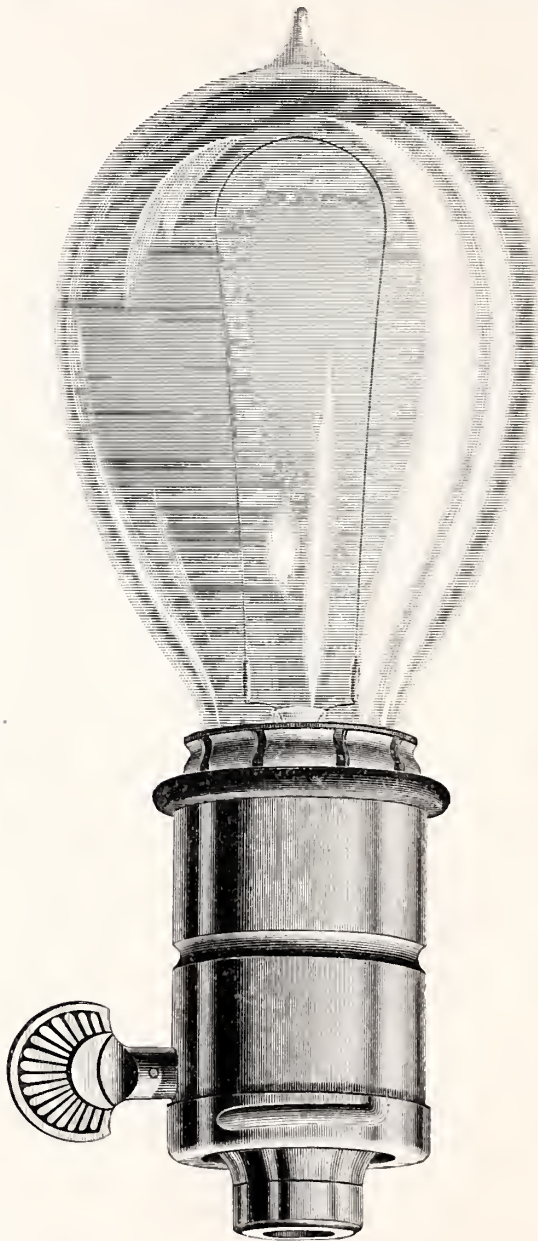

E 1256.

50 to 100 Volts. (16 Candle-power Lamp, and Key Socket.)

Price, complete, as shown with Key Socket, each.....	\$3 00
Complete, with Keyless Socket, each.....	2 70

WESTINGHOUSE FILAMENT LAMP.

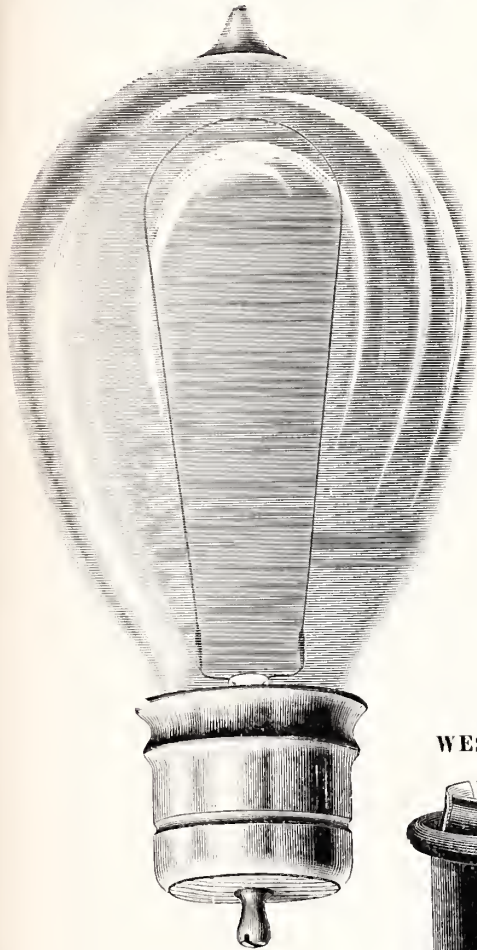

E 1257.

50 to 100 Volts.

10 and 16 Candle-power Lamp...	\$1 50
20 " " " " ...	2 00
50 " " " " ...	3 00

WESTINGHOUSE KEY-LESS SOCKET.

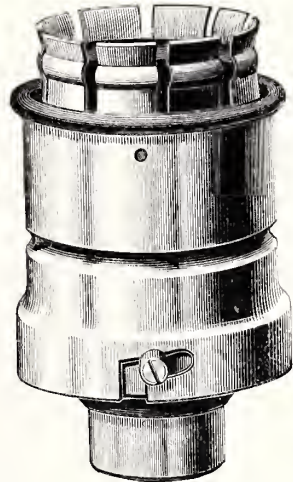

E 1260.

For 16, 25 and 50 Candle-power Lamp.

Price, each \$1.20

WESTINGHOUSE KEY SOCKET.

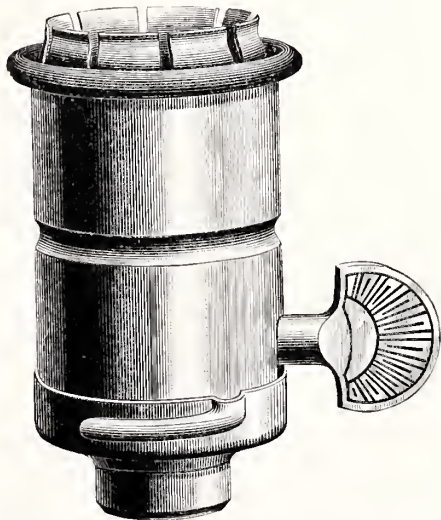

E 1259.

For 16, 25 and 50 Candle-power Lamp.

Price, each \$1.50

SAWYER-MANN LAMP.

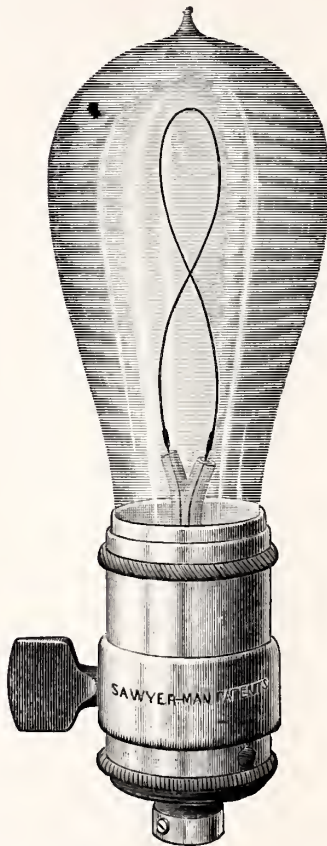

E 1264.

Price of Lamps :

	50 Volts.	75 Volts.	100 Volts.
16 Candle-power, each.....	\$1 40	\$1 50	\$1 60
20 " "	1 50	1 60	1 70
24 " "	1 60	1 70	1 80
32 " "	1 80	1 90	2 00
Key Sockets, each			\$1 50
Keyless " "			1 30

UNITED STATES SYSTEM.

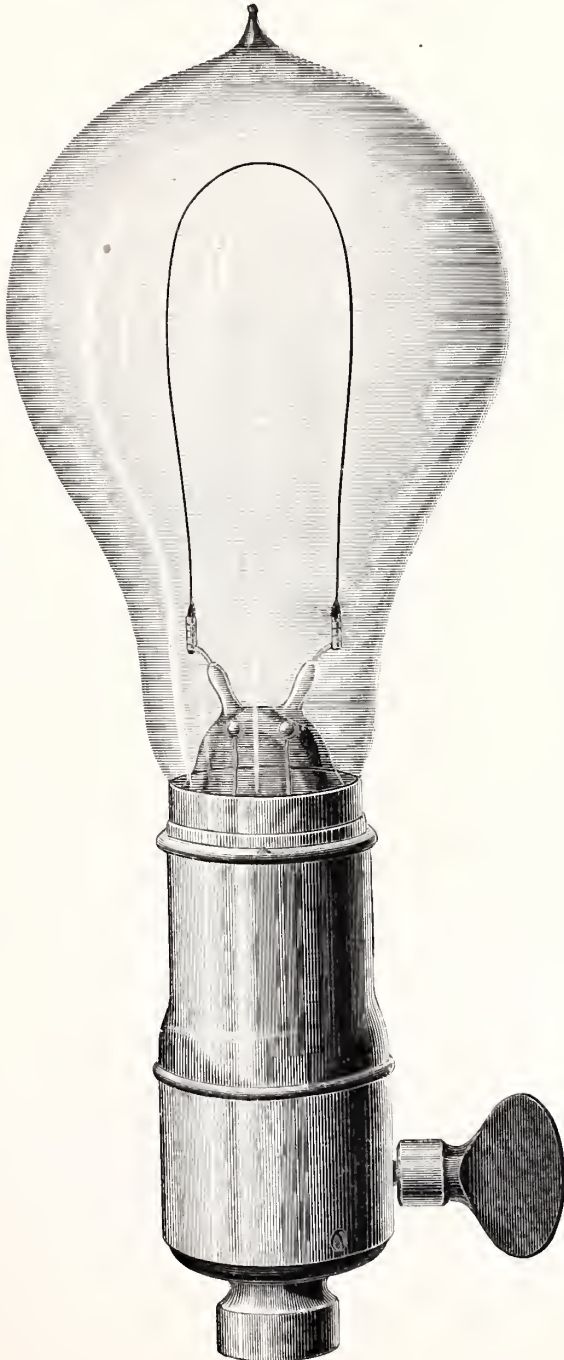

16 Candle-power Lamp.

Lamp 16 Candle-power, 70 or 110 Volts, each.....\$1 70
Key Sockets, each..... 2 00
16 Candle-power Lamp, complete as shown, each..... 3 70

UNITED STATES SYSTEM.

16 Candle-power Lamp.

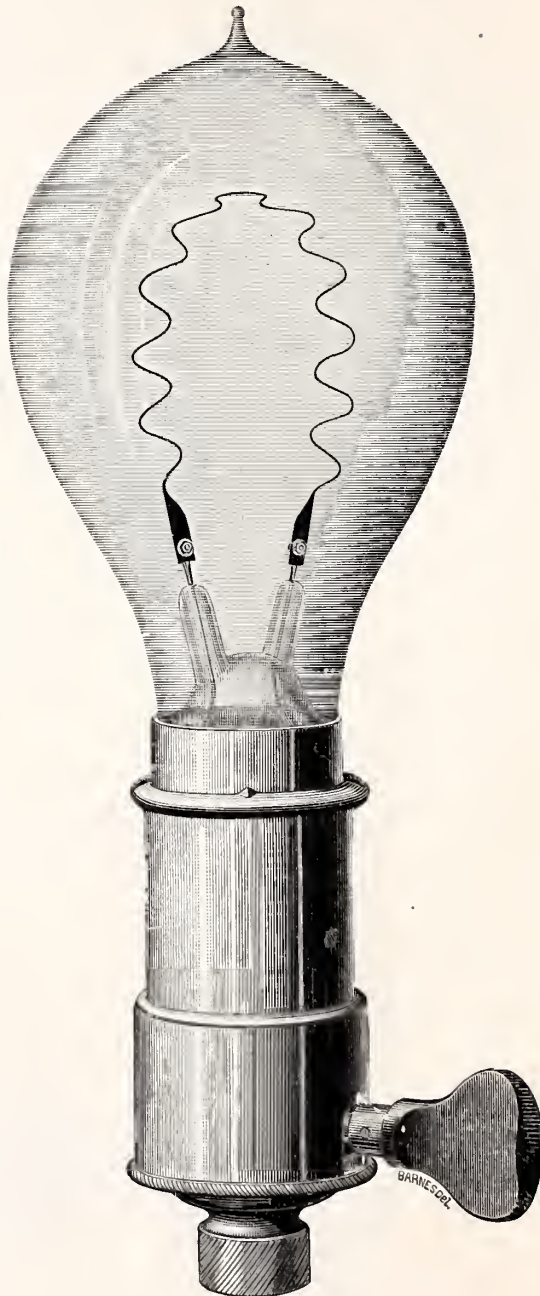

Lamp 16 Candle-power, 70 or 110 Volts, each.....\$1 70
 Key Sockets, each..... 2 00
 16 Candle-power Lamp, complete as shown, each..... 3 70

SWAN FILAMENT LAMPS.

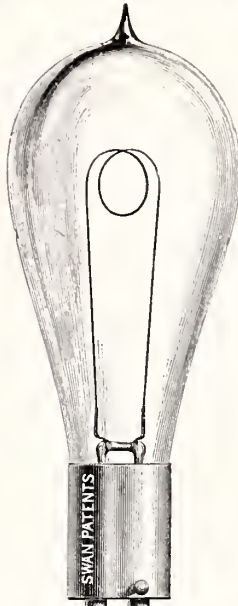

E 1267.

16	Candle-power,	38	Volts;	price,	each	\$1 20
16	"	45	"	"	"	1 60
16	"	92	"	"	"	1 60

KEY SOCKET FOR SWAN LAMP.

KEYLESS SOCKET FOR SWAN LAMP.

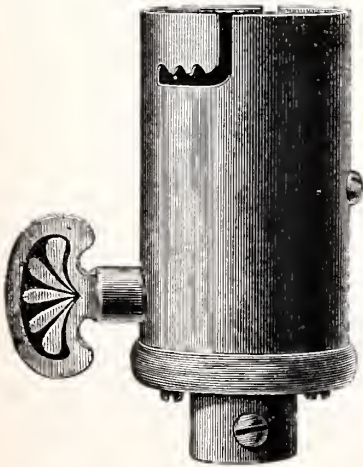

E 1268.

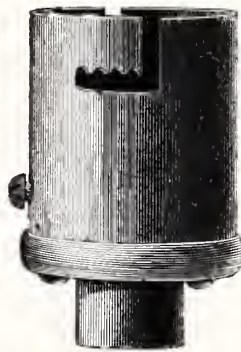

E 1269.

Price, each.....\$1.70 | Price, each..... \$1.00

MATHER LAMP AND SOCKET.

16 Candle-power, each. \$1.70

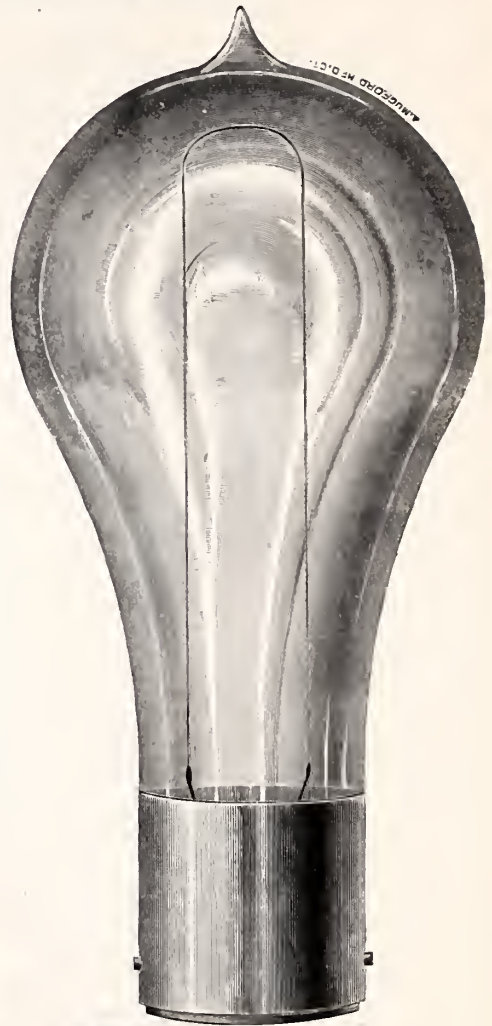

E 1270.

MATHER SOCKET.

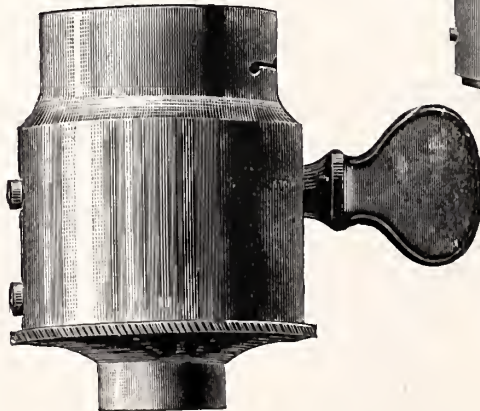

Key Sockets, each. \$1.80

SUN FILAMENT INCANDESCENT LAMP.

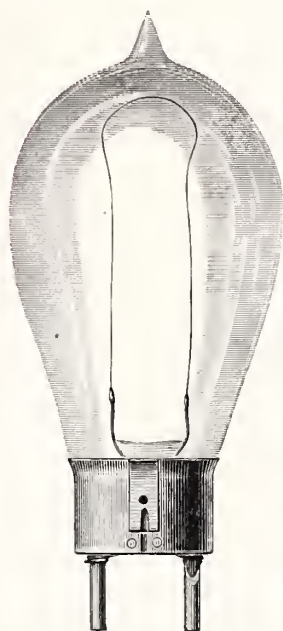

E 1272.

16 Candle-power: 25, 50, and 70 Volts: each.....	\$2 00
16 " " 75, 90, " 100 " "	2 25

KEY SOCKET FOR SUN FILAMENT LAMP.

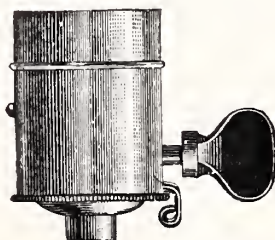

E 1273.

Key Sockets, each	\$2 00
Keyless Sockets, each.....	1 50

SCHEAFER LAMP.

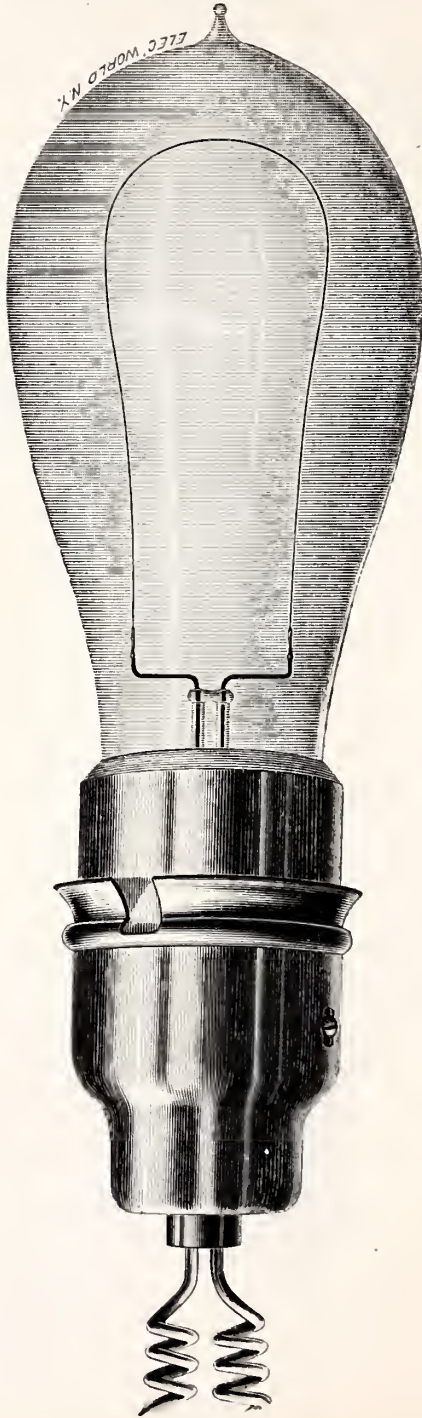

E 1274.

16 Candle-power Lamps, 45 to 50 Volts; price, each.....	\$1 20
16 " " " 65 " 110 " "	1 28
25 " " " 100 " 110 " "	1 44
Key Sockets, each.....	1 12
Keyless Sockets, each.....	1 60

INCANDESCENT GLOBES.

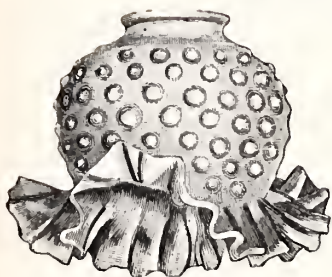

E 1.

Diameter, 5½ in. Height, 5 in.
2¼ and ¾-in. Holder.

Per doz.		Per doz.	
Ruby.....	\$15 00	Amber.....	\$12 00
Canary.....	15 00	Blue.....	12 00
Pink rose.....	15 00	Green.....	12 00
Opalescent.....	12 00	Crystal.....	12 00
SATIN OR VELVET FINISH.			
Pink rose.....	\$20 00	Turquoise.....	\$18 00
Canary.....	20 00	Opalescent.....	18 00

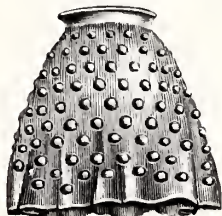

E 3.

Diameter, 5 in. Height, 4½ in.
2¼ and ¾-in. Holder.

Per doz.		Per doz.	
Ruby.....	\$10 00	Amber.....	\$6 00
Canary.....	10 00	Blue.....	6 00
Pink rose.....	10 00	Green.....	6 00
Opalescent.....	6 00	Crystal.....	6 00
SATIN OR VELVET FINISH.			
Pink rose.....	\$16 00	Turquoise.....	\$13 00
Canary.....	16 00	Opalescent.....	13 00

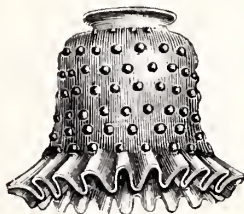

E 5.

Diameter, 5½ in. Height, 4½ in.
2¼ and ¾-in. Holder.

Per doz.		Per doz.	
Ruby.....	\$14 00	Amber.....	\$10 00
Canary.....	14 00	Blue.....	10 00
Pink rose.....	14 00	Green.....	10 00
Opalescent.....	10 00	Crystal.....	10 00
SATIN OR VELVET FINISH.			
Pink rose.....	\$18 00	Turquoise.....	\$16 00
Canary.....	18 00	Opalescent.....	16 00



E 2.

Diameter, 5½ in. Height, 4½ in.
2¼ and ¾-in. Holder.

Per doz.		Per doz.	
Ruby.....	\$14 00	Amber.....	\$10 00
Canary.....	14 00	Blue.....	10 00
Pink rose.....	14 00	Green.....	10 00
Opalescent.....	10 00	Crystal.....	10 00
SATIN OR VELVET FINISH.			
Pink rose.....	\$18 00	Turquoise.....	\$16 00
Canary.....	18 00	Opalescent.....	16 00

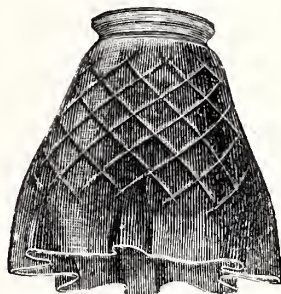

E 4.

Diameter, 5 in. Height, 4½ in.
2¼ and ¾-in. Holder.

Per doz.		Per doz.	
Ruby.....	\$10 00	Amber.....	\$6 00
Canary.....	10 00	Blue.....	6 00
Pink rose.....	10 00	Green.....	6 00
Opalescent.....	6 00	Crystal.....	6 00
SATIN OR VELVET FINISH.			
Pink rose.....	\$16 00	Turquoise.....	\$13 00
Canary.....	16 00	Opalescent.....	13 00

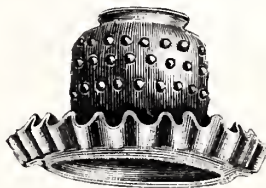

E 6.

Diameter, 6 in. Height, 4 in.
2¼ and ¾-in. Holder.

Per doz.		Per doz.	
Ruby.....	\$14 00	Amber.....	\$10 00
Canary.....	14 00	Blue.....	10 00
Pink rose.....	14 00	Green.....	10 00
Opalescent.....	10 00	Crystal.....	10 00
SATIN OR VELVET FINISH.			
Pink rose.....	\$18 00	Turquoise.....	\$16 00
Canary.....	18 00	Opalescent.....	16 00

INCANDESCENT GLOBES.

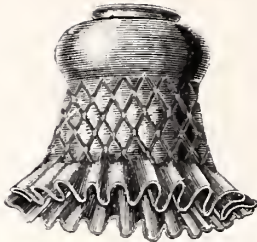

E 7.
Diameter, 6 in. Height, 4½ in.
¾ and ¾-in. Holder.

Per doz.		Per doz.	
Ruby.....	\$14 00	Amber.....	\$10 00
Canary.....	14 00	Blue.....	10 00
Pink rose.....	14 00	Green.....	10 00
Opalescent.....	10 00	Crystal.....	10 00
SATIN OR VELVET FINISH.			
Pink rose.....	\$18 00	Turquoise.....	\$16 00
Canary.....	18 00	Opalescent.....	16 00



E 8.
Diameter, 6 in. Height, 4 in.
¾ and ¾-in. Holder.

Per doz.		Per doz.	
Ruby.....	\$14 00	Amber.....	\$10 00
Canary.....	14 00	Blue.....	10 00
Pink rose.....	14 00	Green.....	10 00
Opalescent.....	10 00	Crystal.....	10 00
SATIN OR VELVET FINISH.			
Pink rose.....	\$18 00	Turquoise.....	\$16 00
Canary.....	18 00	Opalescent.....	16 00

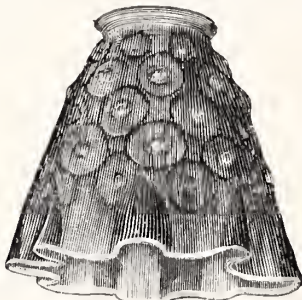

E 9.
Diameter, 5 in. Height, 4½ in.
¾ and ¾-in. Holder.

Per doz.		Per doz.	
Ruby.....	\$10 00	Amber.....	\$6 00
Canary.....	10 00	Blue.....	6 00
Pink rose.....	10 00	Green.....	6 00
Opalescent.....	6 00	Crystal.....	6 00
SATIN OR VELVET FINISH.			
Pink rose.....	\$16 00	Turquoise.....	\$13 00
Canary.....	16 00	Opalescent.....	13 00

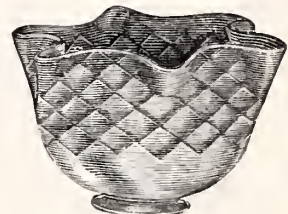

E 10.
Diameter, 6 in. Height, 4 in.
¾ and ¾-in. Holder.

Per doz.		Per doz.	
Ruby.....	\$10 00	Amber.....	\$6 00
Canary.....	10 00	Blue.....	6 00
Pink rose.....	10 00	Green.....	6 00
Opalescent.....	6 00	Crystal.....	6 00
SATIN OR VELVET FINISH.			
Pink rose.....	\$16 00	Turquoise.....	\$13 00
Canary.....	16 00	Opalescent.....	13 00



E 11.
Diameter, 5½ in. Height, 4½ in.
¾ and ¾-in. Holder.

Per doz.		Per doz.	
Ruby.....	\$14 00	Amber.....	\$10 00
Canary.....	14 00	Blue.....	10 00
Pink rose.....	14 00	Green.....	10 00
Opalescent.....	10 00	Crystal.....	10 00
SATIN OR VELVET FINISH.			
Pink rose.....	\$18 00	Turquoise.....	\$16 00
Canary.....	18 00	Opalescent.....	16 00



E 12.
Diameter, 5½ in. Height, 4½ in.
¾ and ¾-in. Holder.

Per doz.		Per doz.	
Ruby.....	\$14 00	Amber.....	\$10 00
Canary.....	14 00	Blue.....	10 00
Pink rose.....	14 00	Green.....	10 00
Opalescent.....	10 00	Crystal.....	10 00
SATIN OR VELVET FINISH.			
Pink rose.....	\$18 00	Turquoise.....	\$16 00
Canary.....	18 00	Opalescent.....	16 00

INCANDESCENT GLOBES.



E 13.

Diameter, 5½ in. Height, 5 in.
2¼ and ¾ in. Holder.

Per doz.		Per doz.	
Ruby.....	\$14 00	Amber.....	\$10 00
Canary.....	14 00	Blue.....	10 00
Pink rose.....	14 00	Green.....	10 00
Opalescent.....	10 00	Crystal.....	10 00

SATIN OR VELVET FINISH.

Pink rose.....	\$18 00	Turquoise.....	\$16 00
Canary.....	18 00	Opalescent.....	16 00



E 15.

Diameter, 6½ in. Height, 4½ in.
2¼ and ¾ in. Holder.

Per doz.		Per doz.	
Ruby.....	\$14 00	Amber.....	\$10 00
Canary.....	14 00	Blue.....	10 00
Pink rose.....	14 00	Green.....	10 00
Opalescent.....	10 00	Crystal.....	10 00

SATIN OR VELVET FINISH.

Pink rose.....	\$18 00	Turquoise.....	\$16 00
Canary.....	18 00	Opalescent.....	16 00



E 17.

Diameter, 4¾ in. Height, 5½ in.
2¼ and ¾ in. Holder.

Per doz.		Per doz.	
Ruby.....	\$10 00	Amber.....	\$6 00
Canary.....	10 00	Blue.....	6 00
Pink rose.....	10 00	Green.....	6 00
Opalescent.....	6 00	Crystal.....	6 00

SATIN OR VELVET FINISH.

Pink rose.....	\$16 00	Turquoise.....	\$13 00
Canary.....	16 00	Opalescent.....	13 00

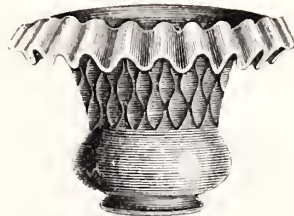

E 14.

Diameter, 6 in. Height, 4½ in.
2¼ and ¾ in. Holder.

Per doz.		Per doz.	
Ruby.....	\$14 00	Amber.....	\$10 00
Canary.....	14 00	Blue.....	10 00
Pink rose.....	14 00	Green.....	10 00
Opalescent.....	10 00	Crystal.....	10 00

SATIN OR VELVET FINISH.

Pink rose.....	\$18 00	Turquoise.....	\$16 00
Canary.....	18 00	Opalescent.....	16 00



E 16.

Diameter, 4½ in. Height, 5 in.
2¼ and ¾ in. Holder.

Per doz.		Per doz.	
Ruby.....	\$14 00	Amber.....	\$10 00
Canary.....	14 00	Blue.....	10 00
Pink rose.....	14 00	Green.....	10 00
Opalescent.....	10 00	Crystal.....	10 00

SATIN OR VELVET FINISH.

Pink rose.....	\$18 00	Turquoise.....	\$16 00
Canary.....	18 00	Opalescent.....	16 00



E 18.

Diameter, 5 in. Height, 4½ in.
2¼ and ¾ in. Holder.

Rich Cut and Etched Glass.

Per doz.....	\$36 00
--------------	---------

INCANDESCENT GLOBES.



E 19.

Diameter, 4 in. Height, 5 in.
 2¼ and 3¼-in. Holder.
 Rich Cut and Etched Glass.

Per doz. \$30.00



E 21.

Diameter, 4 in. Height, 5 in. -
 2¼ and 3¼-in. Holder.
 Rich Cut Glass.

Per doz. \$40.00



E 23.

Diameter, 4 in. Height, 5 in.
 2¼ and 3¼-in. Holder.
 Rich Cut Glass.

Per doz. \$40.00



E 20

Diameter, 5 in. Height, 5 in.
 2¼ and 3¼-in. Holder.

Rich Cut Glass. Per doz. \$40.00



E 22.

Diameter, 6 in. Height, 4 in.
 2¼ and 3¼-in. Holder.

	Per doz.		Per doz.
Ruby	\$14 00	Amber	\$10 00
Canary	14 00	Blue	10 00
Pink rose	14 00	Green	10 00
Opalescent	10 00	Crystal	10 00

SATIN OR VELVET FINISH.

Pink rose, per doz.	\$18 00
Canary, "	18 00
Turquoise, "	16 00
Opalescent, "	16 00



E 24.

Diameter, 3½ in. Height, 4½ in.
 2¼ and 3¼ in. Holder.

Rich Cut Glass. Per doz. \$50.00

INCANDESCENT GLOBES.



E 25.

Diameter, 5½ in. Height, 3½ in.
2¼ and 3¼-in. Holder.
Rich Cut Glass.

Per doz. \$50.00

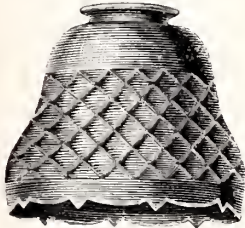

E 27.

Diameter, 5 in. Height, 5 in.
2¼ and 3¼-in. Holder.

	Per doz.		Per doz.
Ruby	\$14 00	Amber	\$10 00
Canary	14 00	Blue	10 00
Pink rose	14 00	Green	10 00
Opalescent	10 00	Crystal	10 00

SATIN OR VELVET FINISH.

Pink rose, per doz	\$18 00
Canary, "	18 00
Turquois, "	16 00
Opalescent, "	16 00



E 29.

Diameter, 3½ in. Height, 5 in.
2¼ and 3¼-in. Holder.

	Per doz.		Per doz.
Ruby	\$10 00	Amber	\$6 00
Canary	10 00	Blue	6 00
Pink rose	10 00	Green	6 00
Opalescent	6 00	Crystal	6 00

SATIN OR VELVET FINISH.

Pink rose, per doz	\$16 00
Canary, "	16 00
Turquois, "	12 00
Opalescent, "	12 00



E 26.

Diameter, 5 in. Height, 5 in.
2¼ and 3¼-in. Holder.
Rich Cut Glass.

Per doz. \$35 00

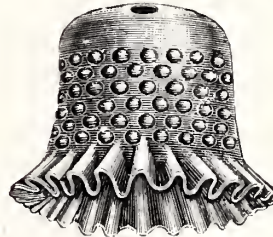

E 28.

Diameter, 6 in. Height, 5 in.

With hole 1 in. to 3¼ in. Diameter. No Lip.

	Per doz.		Per doz.
Ruby	\$14 00	Amber	\$10 00
Canary	14 00	Blue	10 00
Pink rose	14 00	Green	10 00
Opalescent	10 00	Crystal	10 00

SATIN OR VELVET FINISH.

Pink rose, per doz	\$20 00
Canary, "	20 00
Turquois, "	18 00
Opalescent, "	18 00



E 30.

Diameter, 5 in. Height, 5 in.
2¼ and 3¼-in. Holder.

Crystal. Etched, per doz. \$14 00

INCANDESCENT GLOBES.



E 31.

Diameter, 6 in. Height, 4 in.
 2¼ and 3¼-in. Holder.
 Crystal, Etched.

Per doz\$12.00



E 32.

Diameter, 6 in. Height, 5 in.
 2¼ and 3¼-in. Holder.
 Crystal, Etched.

Per doz\$12.00



E 33.

Diameter, 5 in. Height, 5½ in.
 2¼ and 3¼-in. Holder.
 Crystal, Etched.

Per doz.....\$10.00



E 34.

Diameter, 6 in. Height, 4½ in.
 4-in. Holder.
 Crystal, Etched.

Per doz.....\$12.00



E 35.

Diameter, 5 in. Height, 5 in.
 2¼ and 3¼-in. Holder.
 Crystal, Etched.

Per doz\$10.00



E 36.

Diameter, 6 in. Height, 5 in.
 4-in. Holder.
 Crystal, Etched.

Per doz.....\$12.00

INCANDESCENT GLOBES.



E 37.

Diameter, 6 in. Height, $3\frac{1}{2}$ in.

$2\frac{1}{4}$, $3\frac{1}{4}$ and 4-in. Holder.

Crystal, Etched, per doz.....\$6.00



E 39.

Diameter, $6\frac{1}{2}$ in. Height, 3 in.

$2\frac{1}{4}$, $3\frac{1}{4}$ and 4-in. Holder.

	Per doz.		Per doz.
Ruby	\$8 00	Amber	\$6 00
Canary	8 00	Blue	6 00
Pink rose	8 00	Green	6 00
Opalescent	6 00	Crystal	6 00

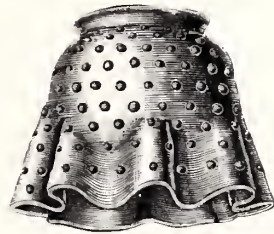

E 38.

Diameter, 5 in. Height, 4 in.

$2\frac{1}{4}$, $3\frac{1}{4}$ and 4-in. Holder.

	Per doz.		Per doz.
Ruby	\$8 00	Amber	\$6 00
Canary	8 00	Blue	6 00
Pink rose	8 00	Green	6 00
Opalescent	6 00	Crystal	6 00



E 40.

With Hole 1 in. Diameter; or to fit Edison Socket.

Diameter, 6 in. Height, $4\frac{1}{2}$ in.

	Per doz.		Per doz.
Ruby	\$12 00	Amber	\$8 00
Canary	12 00	Blue	8 00
Pink rose	12 00	Green	8 00
Opalescent	8 00	Crystal	8 00

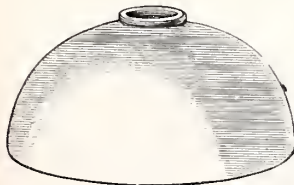

E 41.

OPAL.

Diameter, 8, 9, 10 in. Height, $4\frac{1}{2}$ in.

$2\frac{1}{4}$ and $3\frac{1}{4}$ -in. Holder.

8-in diameter, per doz.....	\$8 00
9 " " " " " " " " " " " "	9 00
10 " " " " " " " " " " " "	9 00

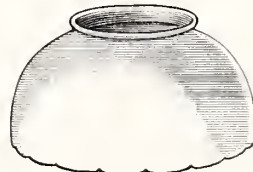

E 42.

OPAL.

Diameter, $7\frac{1}{2}$ in. Height, $3\frac{1}{2}$ in.

4-in. Holder.

Per doz.....\$8.00

INCANDESCENT GLOBES.



E 43.

Diameter, 8 in. Height, 4 in.
4-in. Holder.

Crystal, Etched, per doz. \$18.00



E 44.

Diameter, 8 in. Height, 4½ in.
4-in. Holder.

Crystal, Etched, per doz. \$18 00
Ruby. " " 25 00

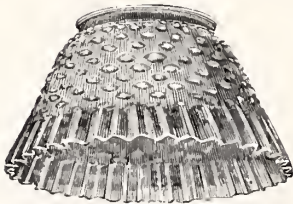

E 45.

Diameter, 8 in. Height, 4½ in.
4-in. Holder.

	Per doz.		Per doz.
Ruby.....	\$15 00	Amber.....	\$12 00
Canary.....	15 00	Blue.....	12 00
Pink rose.....	15 00	Crystal.....	12 00
Opalescent.....	12 00		



E 46.

Diameter, 7½ in. Height, 5 in.
4-in. Holder.

	Per doz.		Per doz.
Ruby.....	\$15 00	Amber.....	\$12 00
Canary.....	15 00	Blue.....	12 00
Pink rose.....	15 00	Green.....	12 00
Opalescent.....	12 00	Crystal.....	12 00



E 47.

Diameter, 5 in. Height, 4 in.
2¼ and ¾-in. Holder.

Crystal, Etched, per doz. \$14.00



E 48.

Diameter, 6 in. Height, 4 in.
2¼ and ¾-in. Holder.

Crystal, Etched, per doz. \$10.25

INCANDESCENT GLOBES.



E 49.

Diameter, 5½ in. Height, 4 in.

2¼-in. Holder.

	Per doz.		Per doz.
Ruby	\$10 00	Amber	\$6 00
Canary	10 00	Blue.....	6 00
Pink rose	10 00	Green.....	6 00
Opalescent	6 00	Crystal.....	6 00



E 50.

Diameter, 5 in. Height, 4 in.

2¼ and 3¼-in. Holder.

Crystal, Etched, per doz.....\$12.00



E 51.

Diameter, 6 in. Height, 4 in.

3¼-in. Holder.

Crystal, Etched, per doz.....\$11.25



E 52.

Diameter, 5½ in. Height, 4½ in.

2¼ and 3¼-in. Holder.

Crystal, Etched, per doz.....\$12.00



E 53.

Diameter, 8 in. Height, 4½ in.

3¼ and 4½-in. Holder.

Crystal, Etched, per doz.....\$11.25



E 54.

Diameter, 6, 7 and 8 in. Height, 3 in.

2¼-in. Holder.

6-in diameter, per doz.....	\$9 40
7 " " " " " " " " " " " "	10 25
8 " " " " " " " " " " " "	12 00

INCANDESCENT GLOBES AND SHADES.



E 55.

Diameter, 6, 7, 8, 9 and 10 in.
 Height, $3\frac{1}{4}$ in.
 $2\frac{1}{4}$ and $3\frac{1}{4}$ -in. Holder.

		Per doz.
Opal Glass, 6-in. diameter.....		\$3 50
" 7 " ".....		4 00
" 8 " ".....		4 50
" 9 " ".....		5 50
" 10 " ".....		6 00

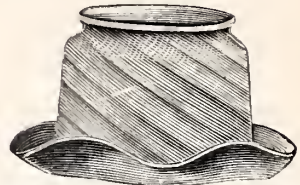

E 56.

Diameter, 6 in. Height, 4 in.
 $3\frac{1}{4}$ -in. Holder.

Per doz.		Per doz.
Ruby.....	\$10 00	Amber.....\$6 00
Canary.....	10 00	Blue..... 6 00
Pink rose.....	10 00	Green..... 6 00
Opalescent.....	6 00	Crystal..... 6 00

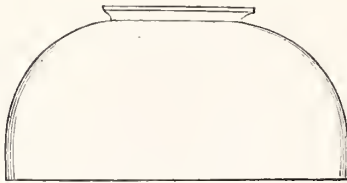

E 57.

Diameter 6, $6\frac{1}{2}$, 7 and $7\frac{1}{2}$ in.
 Height, $3\frac{1}{2}$ in.
 $3\frac{1}{4}$ -in. Holder.

		Per doz.
Opal Glass, 6-in. diameter.....		\$4 25
" $6\frac{1}{2}$ " ".....		4 70
" 7 " ".....		5 00
" $7\frac{1}{2}$ " ".....		5 50



E 58.

Diameter, 5, 6, 7, 8 and $8\frac{1}{2}$ in.
 Height, 3 in.
 $2\frac{1}{4}$ and $3\frac{1}{4}$ -in. Holder.

		Per doz.
Opal Glass, 5-in. diameter.....		\$3 00
" 6 " ".....		3 50
" 7 " ".....		4 00
" 8 " ".....		5 50
" $8\frac{1}{2}$ " ".....		6 00

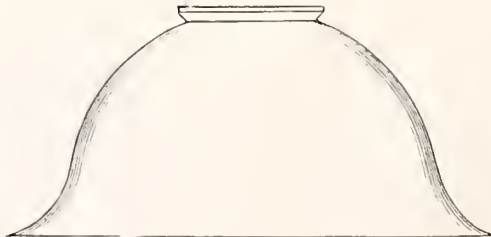

E 59.

Diameter, 10 in. Height, 5 in.
 $3\frac{1}{4}$ -in. Holder.

Opal Glass, per doz.....	\$8.50
--------------------------	--------

INCANDESCENT GLOBES AND SHADES.

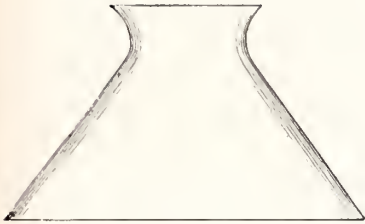

E 60.

Diameter, 8, 9 and 10 in.

Height, $4\frac{1}{2}$ in.

$3\frac{1}{4}$ -in. Holder.

	Per doz.
Opal Glass, 8-in. Diameter.....	\$4 70
“ 9 “	5 00
“ 10 “	5 50

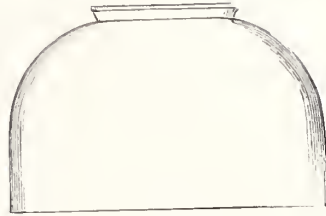

E 61.

Diameter, 6, $6\frac{1}{2}$, 7 and $7\frac{1}{2}$ in.

Height, $4\frac{1}{2}$ in.

$3\frac{1}{4}$ -in. Holder.

	Per doz.
Opal Glass, 6-in. Diameter.....	\$4 70
“ $6\frac{1}{2}$ “	5 00
“ 7 “	5 50
“ $7\frac{1}{2}$ “	6 00



E 62.

Diameter, 6, 7 and 8 in. Height, 3 in. $2\frac{1}{4}$ and $3\frac{1}{4}$ -in. Holder.

	Per doz.
Opal Glass, 6-in. Diameter.....	\$3 50
“ 7 “	4 00
“ 8 “	4 50

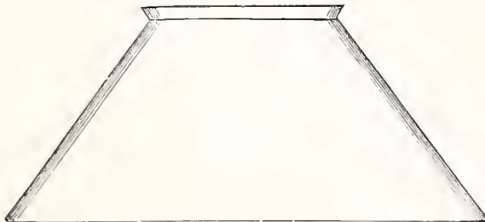

E 63.

Diameter, 10 in. Height, $4\frac{1}{2}$ in. 4-in. Holder.

Opal Glass, per doz	\$5.50
---------------------------	--------

ARC LAMP GLOBES.

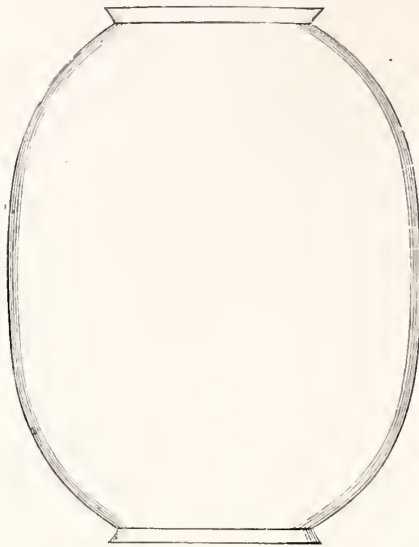

E 64.

Diameter, 9 in. Height, 11 in.
4 1/2-in. Holder.

Opal Glass, per doz.	\$12 00
Roughed Glass, per doz.	12 00
Flint " " "	11 25

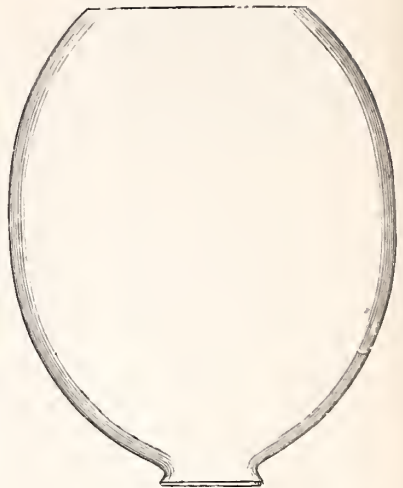

E 65.

Diameter, 8 in. Height, 10 in.
2 1/4-in. Holder.

Opal Glass, per doz.	\$10 25
Roughed Glass, per doz.	10 25
Flint " " "	9 40

INCANDESCENT SHADES.

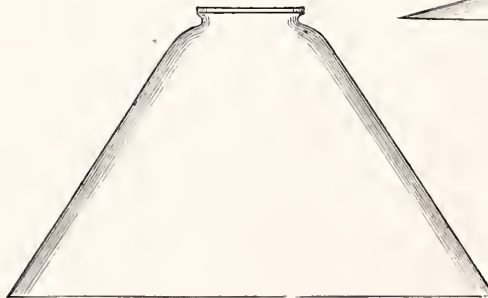

E 67.

Diameter, 10 in. Height, 6 in.
2 1/4 and 3 1/4-in. Holder.

Opal, per doz.	\$6.00
----------------	-------	--------

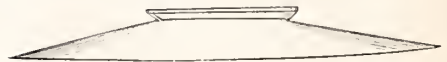

E 68.

Diameter, 6, 7, 8, 9 and 10 in., etc.
Height, 1 1/2 in.
2 1/4 and 3 1/4-in. Holder.

		Per doz.
Opal, 6-in. diameter.	\$3 25
" 7 "	3 50
" 8 "	3 75
" 9 "	4 00
" 10 "	4 25
" 12 "	8 50
" 14 "	12 00
" 16 "	18 00
" 18 "	24 00
" 20 "	32 00
" 22 "	40 00

ARC LAMP GLOBES.

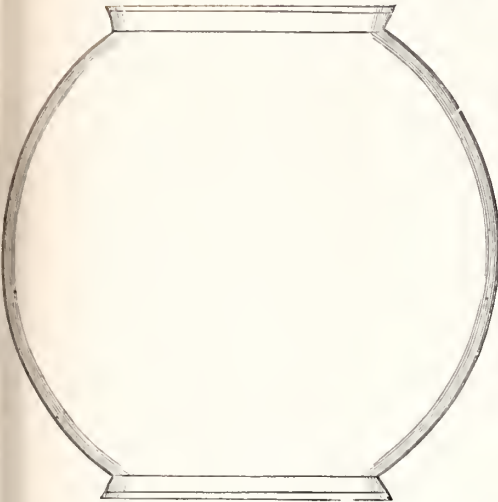

E 69

Diameter, 10 in. Height, 10 in.
6-in. Holder.

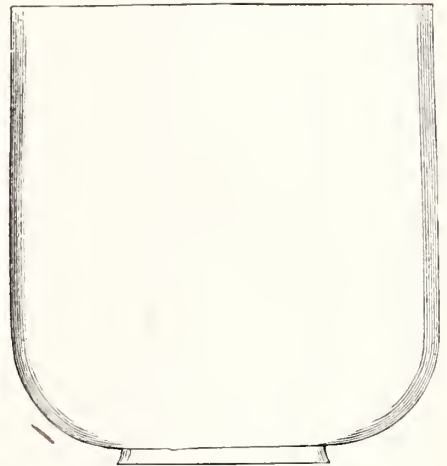

E 70.

Diameter, 9 in. Height, 9 in.
4-in. Holder.

Opal, per doz.....	\$15 00
Roughed, per doz.....	15 00
Flint " ".....	13 00

Opal, per doz.....	\$11 25
Roughed, per doz.....	11 25
Flint, " ".....	10 25

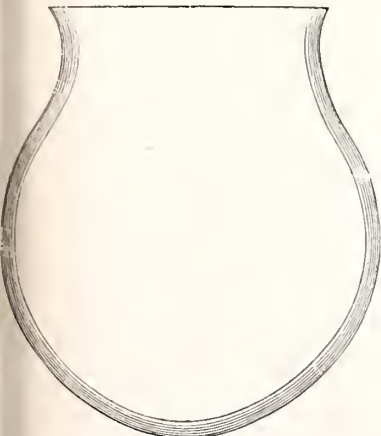

E 71.

Diameter, 8 in. Height, 9 in.
6-in. Holder.

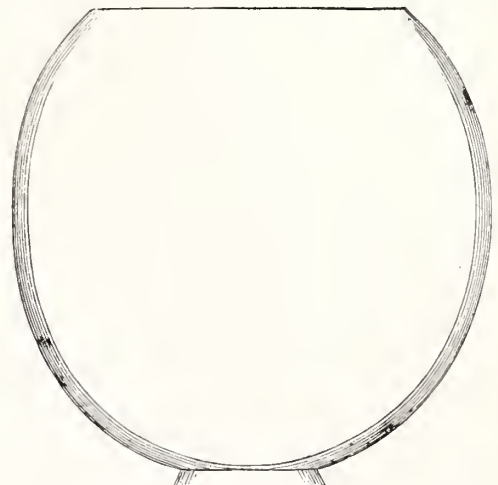

E 72.

Diameter, 10 in. Height, 10 in.
3¼ and 4-in. Holder.

Opal, per doz.....	\$11 25
Roughed, per doz.....	11 25
Flint, " ".....	10 25

Opal, per doz.....	\$11 25
Roughed, per doz.....	11 25
Flint, " ".....	10 25

ARC LAMP GLOBES.

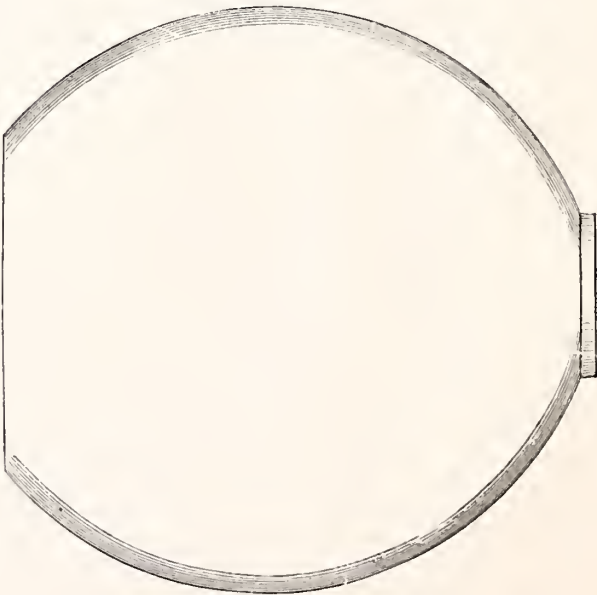

E 73.

Diameter, 12 in. Height, 12 in. 4-in. Holder.

Opal, per doz.....	\$14 00
Roughed, per doz.....	14 00
Flint,	12 00

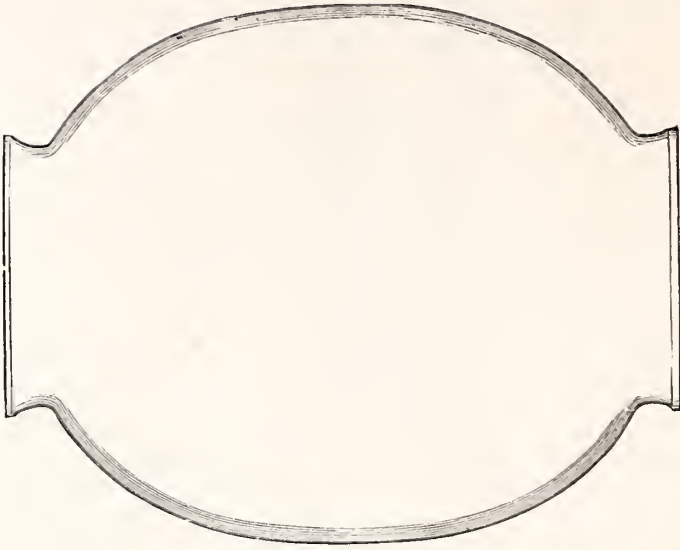

E 74

Diameter, 10 in. Height, 12 in. 6-in. Holder.

Opal, per doz.....	\$16 75
Roughed, per doz.....	16 75
Flint,	15 00

ARC LAMP GLOBES.

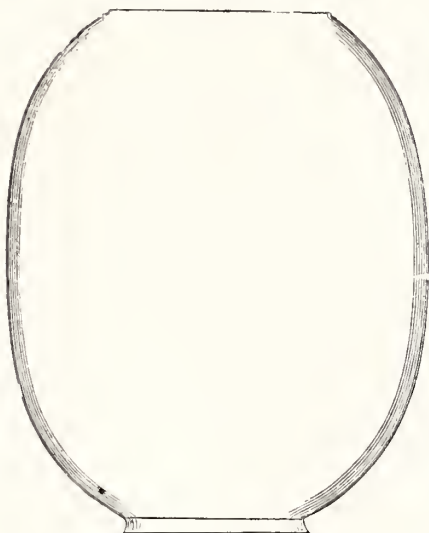

E 75.

Diameter, 9 in. Height, 11 in. 4-in. Holder.

Opal, per doz	\$11 25
Roughed, per doz	11 25
Flint, "	10 25

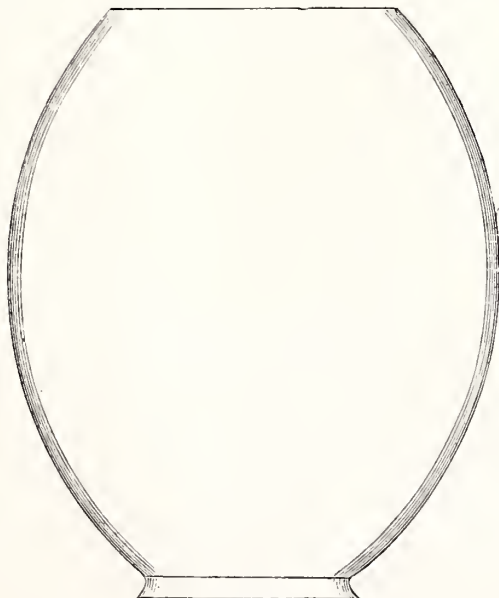

E 76.

Diameter, 10 in. Height, 12 in. 4½-in. Holder.

Opal, per doz	\$15 00
Roughed, per doz	15 00
Flint, "	13 00

ARC LAMP GLOBES.

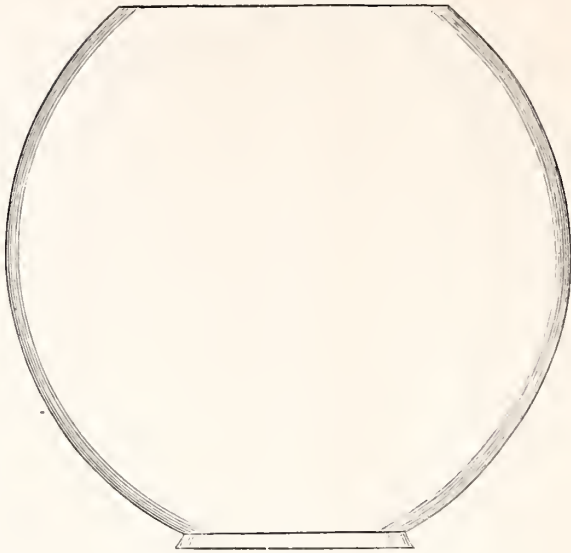

E 77.

Diameter, 11 inches. Height, 11 inches. 5-in. Holder.

Opal, per doz.....	\$14 00
Roughed, per doz.....	14 00
Flint, ".....	12 00

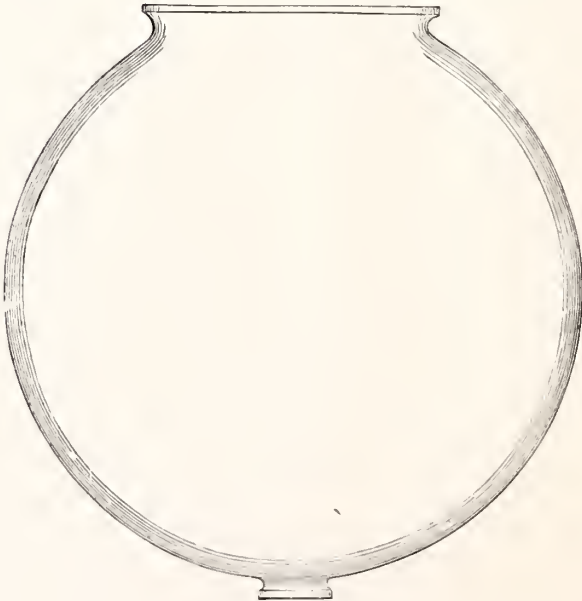

E 78.

Diameter, 12 in. Height, 12 in. 1½-in. Holder.

Opal, per doz.....	\$16 75
Roughed, per doz.....	16 75
Flint, ".....	15 00

ARC LAMP GLOBES.

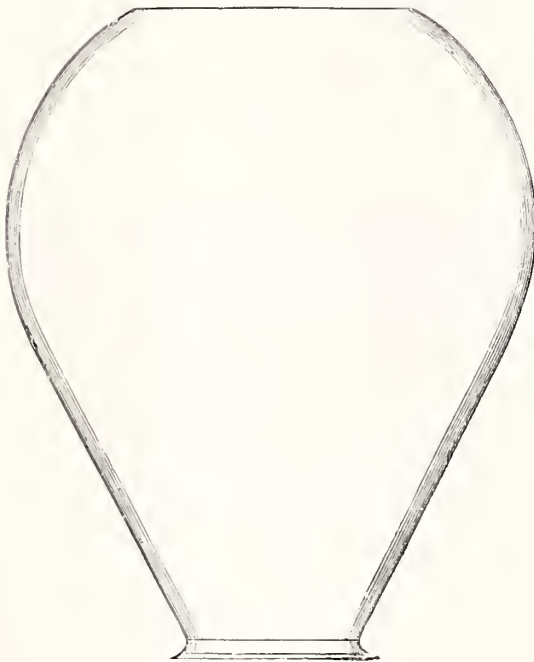

E 79.

Diameter, 11 in. Height, 13 in.

4-in. Holder.

	Per doz.
Opal	\$16 75
Roughed	16 75
Flint	15 00

CABIN LIGHT.

*Polished Mahogany Frame (other woods to order), Switch, Nickeled Reflector,
Frosted Glass, Lamps easily accessible.*

Fitted for 16 Candle-power Incandescent Lamps, any system.

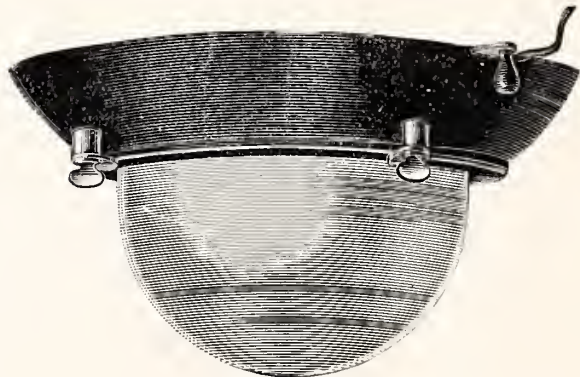

E 1073.

Diameter, 10½ in. Depth, 5½ in.

Price, each\$16.25

INCANDESCENT STREET LAMP.

PATENT APPLIED FOR.

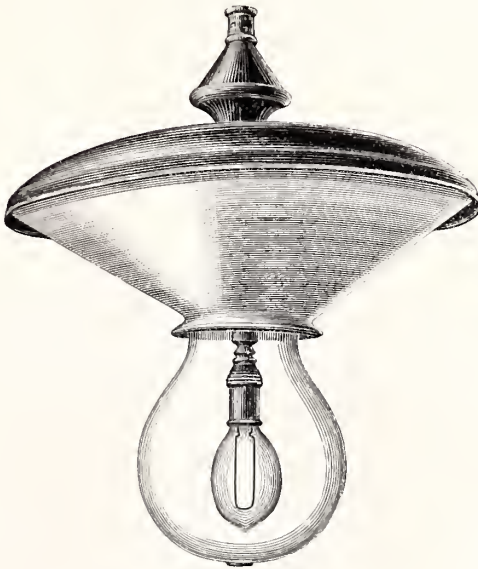

E 1074.

Water-proof, with opal glass reflector and metal top.

This Lamp is in use in several cities, for street lighting, and is giving good satisfaction. It is so constructed that the Glass Globe and Porecelain Reflector is removable, without in any way disturbing the Lamp, exposing the interior for testing, wiring, etc., etc. There is plenty of room in the top for an Insulating Joint.

Lamps in stock are arranged for a 3/8-in. Iron Pendant or Bracket.

No. 1— { Diameter of Reflector, 14 in. } Each.....\$7 50
 { Height of Lamp.....18 in. }

No. 1 will fit any 16 Candle-power Filament Lamp.

No. 2— { Diameter of Reflector, 20 in. } Each.....\$25 00
 { Height of Lamp.....24 in. }

No. 2 will fit all Filament Lamps up to 150 Candle-power.

We also make a substantial Bracket of 1/2-in. Iron Pipe, 2 feet long, for suspending Electric Street Lamps. Has a 4-in. Flange to screw against upright, 3/8-in. iron male at Lamp end, painted with a weather-resisting paint.

Style E 758, price, each.....\$2 50
 " E 760, " " 3 75

REVERSIBLE SIDE LAMP, WITH WIRE HINGE GUARD.

WOODEN BACK. CORRUGATED METAL FACE.

FOR ANY INCANDESCENT SYSTEM.

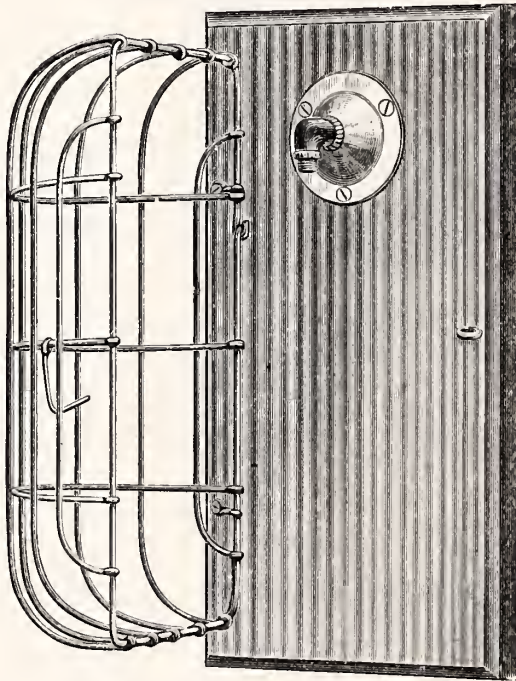

E 1075.

Height, 15 in. Width, 7 in. Depth, 5 in.

Price, each.....\$9.00

REVERSIBLE SIDE LAMP, WITH GUARD.

NICKEL-PLATED.

For any Incandescent System.

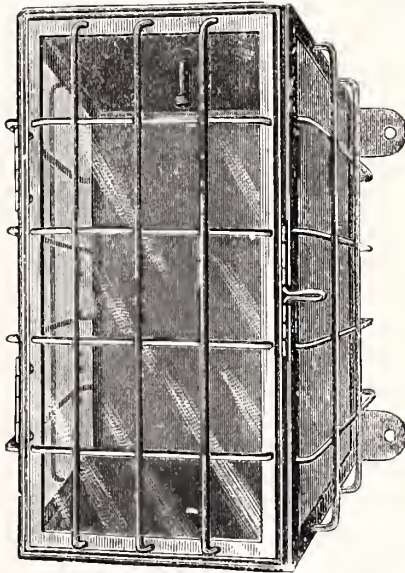

E 1076.

Height, 11½ in. Width, 6 in. Depth, 4 in.

Price, each.....\$20.00

SIDE LAMP, WITHOUT REFLECTOR.

For any Incandescent System.

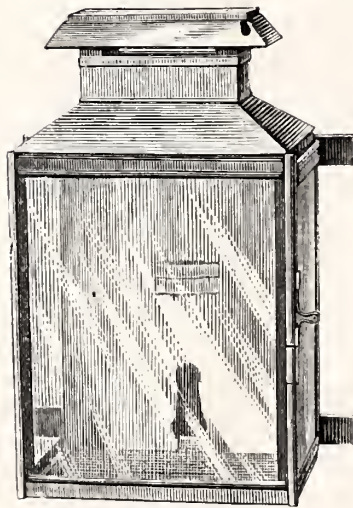

E 1077.

No. 1.—	7	x	9 inches wide,	16 inches high.....	\$4 25
“ 2.—	7½	x	12	“ 18 “	5 00
“ 3.—	10	x	12	“ 18 “	6 50
“ 4.—	11	x	16	“ 22 “	8 50
“ 5.—	12	x	18	“ 24 “	10 00

HALF-ROUND SIDE LAMP.

With Corrugated Silvered Glass Back and Clear Glass Front.

FOR ANY INCANDESCENT SYSTEM.



E 1078.

Height, 25 in. Width, 13 in. Depth, 9 in.

Price, each.....\$14.25

SIDE LAMP.

FOR ANY INCANDESCENT SYSTEM.

Polished Brass.

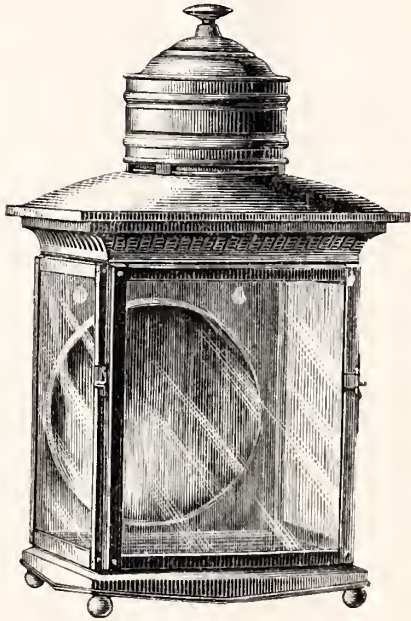

E 1079.

Height, 23 in. Width, 13 in.

Price, \$50.00

SIDE LAMP.

FOR ANY INCANDESCENT SYSTEM.

Polished Brass.

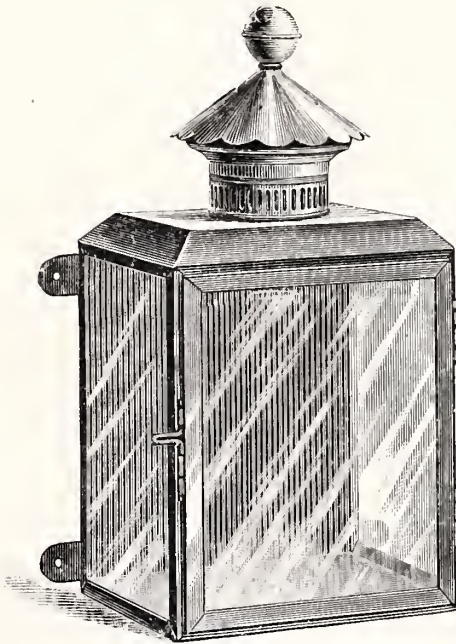

E 1080.

No. 1.—17 x 9 x 7½ in.....	\$13 50
“ 2.—22 x 11 x 8½ “	16 75

FANCY SIDE LAMP.

With Corrugated Silvered Glass Back and Clear Glass Front.

FOR ANY INCANDESCENT SYSTEM.

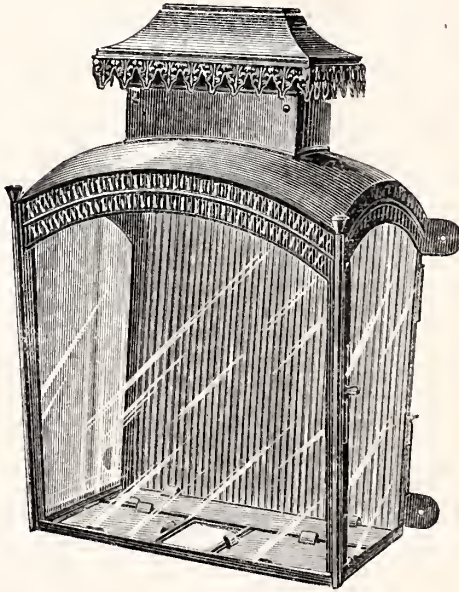

E 1081.

Size, 9 x 16 x 24 in.

Tin Frame, Bronzed, each.....	\$15 00
Polished Brass Frame, Beveled Plate Glass.....	33 75

TRIANGLE LAMP, WITH FLAT FACE.

With White Enameled Iron Reflecting Back and Clear Glass Front.

FOR ANY INCANDESCENT SYSTEM.

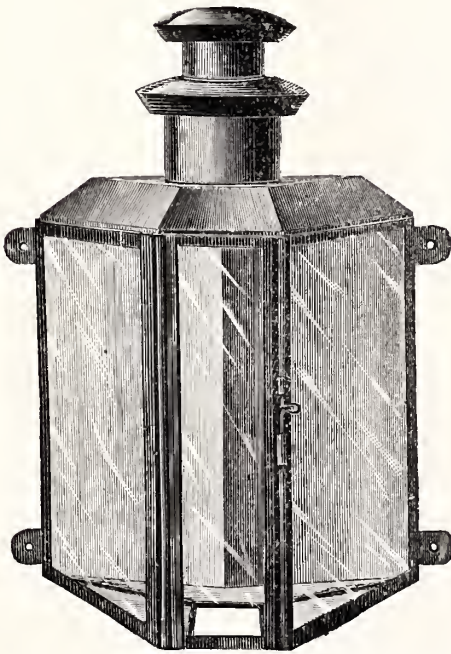

E 1082

Height, 23 in. Depth, 10 in.

Width of back, 15 in.

Price, each.....\$8.50



E 1083.

BEACON SIDE LAMP.

FOR ANY INCANDESCENT SYSTEM.

*Polished Brass Frame, with
French Plate Beveled Glass
and Corrugated Silver
Glass Back.*

No. 1. Height, 23 inches.

Width, 14 $\frac{1}{4}$ inches.

Price, each.....\$42.25

No. 2. Height, 26 inches.

Width, 16 $\frac{1}{2}$ inches.

Price, each.....\$50.00

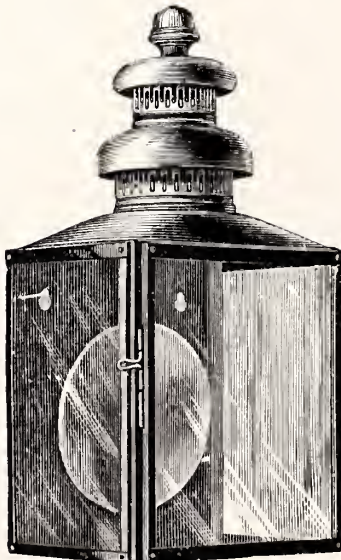

E 1084.

BRASS SIDE LAMP.

Double Thick Glass.

FOR ANY INCANDESCENT SYSTEM.

Width, 10 inches.

Depth, 7 $\frac{1}{2}$ inches.

Height, 20 inches.

Price, each.....\$16.75

CUT GLOBE AND FANCY BRACKET

FOR ANY INCANDESCENT SYSTEM,

SUSPENDED.

*Adjustable Clusters, Figs. E 472 and E 473, from Two to Six-
Light can be arranged to fit Lantern.*

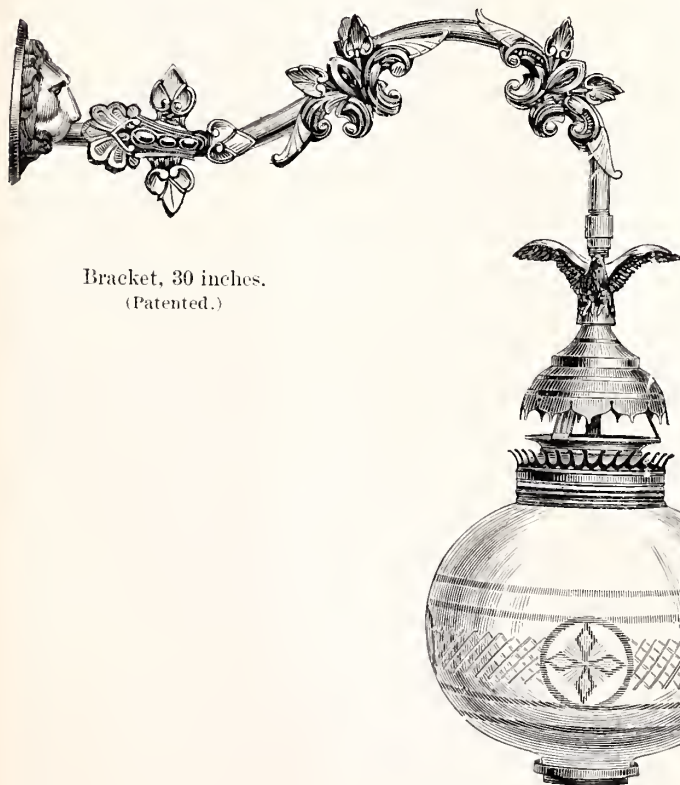

Bracket, 30 inches.
(Patented.)

E 1088.

Diameter of Globe, 14 inches ; price, complete.....\$37.00

CUT GLASS GLOBE AND BRACKET.

WITH SPUN BRASS CANOPY.—(Patented.)

FOR ANY INCANDESCENT SYSTEM.

Adjustable Clusters, Figs. E 472 and E 473, from Two to Six-Light, can be arranged to fit Lantern.

Height, 24 in.; diameter, 12 in.; length of bracket, 15 in.
 Price, complete.....\$24.50.

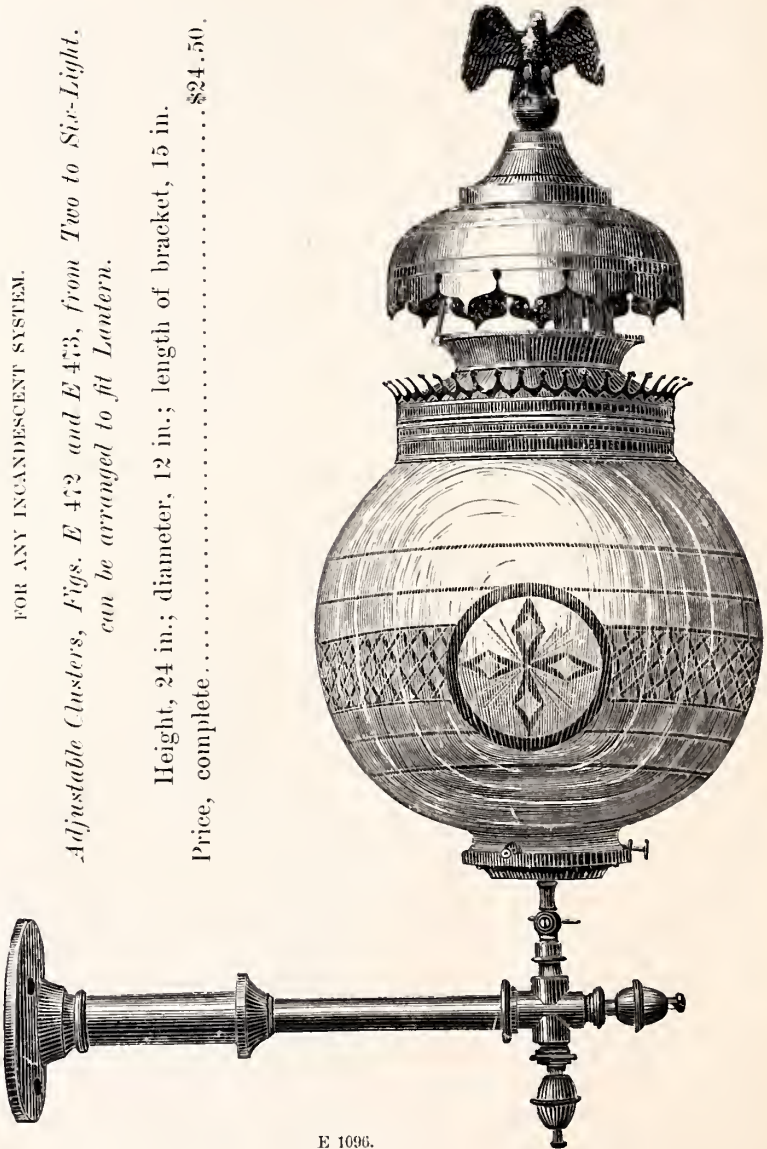

E 1096.

ICE CREAM LAMP.

FOR ANY INCANDESCENT SYSTEM.

Lettered on Two Sides.

Adjustable Clusters, Figs. E 472 and E 473, from Two to Six-Light, can be arranged to fit Lantern.



E 1097.

Height, 3 feet. Diameter, 24 in. Width, 15 in. Size of Glass, 16 in.

This Lamp is designed for a post, or to suspend.

Price, complete (without Bracket or Post) \$59.00

BILLIARD LAMP.

FOR ANY INCANDESCENT SYSTEM.

*Adjustable Clusters, Figs. E 472 and E 473, from Two to Six-Light,
can be arranged to fit Lantern.*

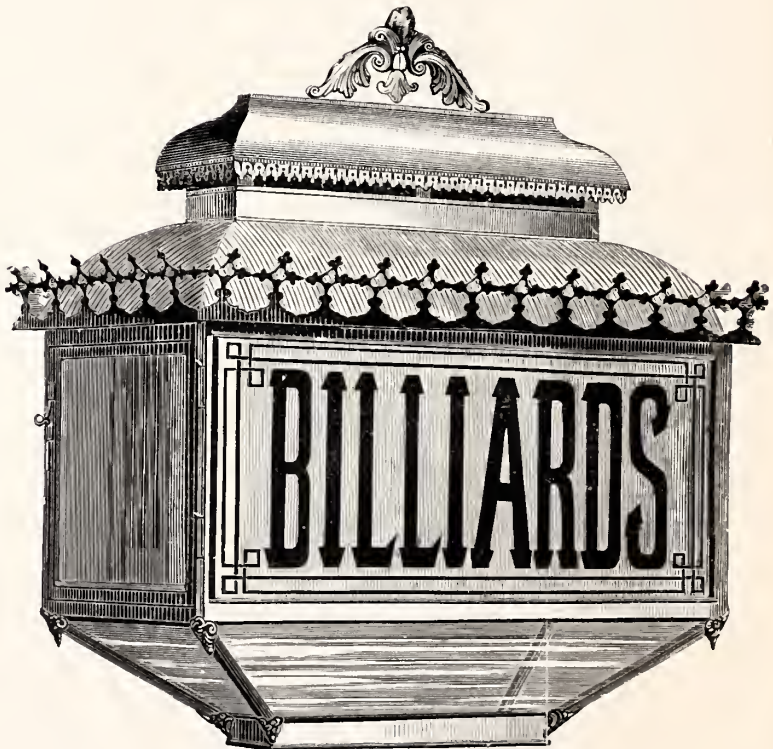

E 1098.

Length, 40 in. Height, 36 in. Width, 19 in.

Price, including colored glass and lettering on two sides \$70.75

FOR ANY INCANDESCENT SYSTEM.

Adjustable Clusters, Figs. E 472 and E 473, from Two to Six-Light, arranged to fit Lanterns.

NEWEL POST AND CUT GLOBE.

NEWEL POST AND DELMONICO LAMP.

Height of Post54 in.

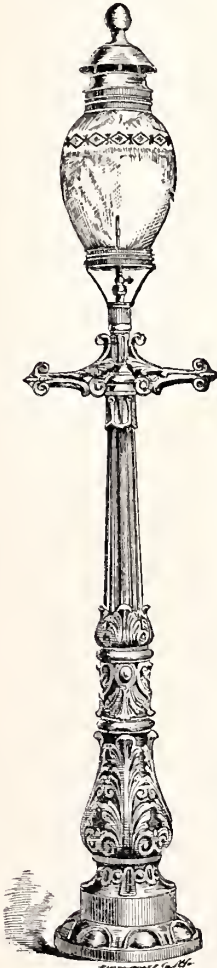

E 1099

Diameter of Base.....12½ in.

Height of Globe and Canopy, 22 in.
Diameter of Globe, 10 in.

Price, complete.....\$38 75

Height of Post.....54 in.

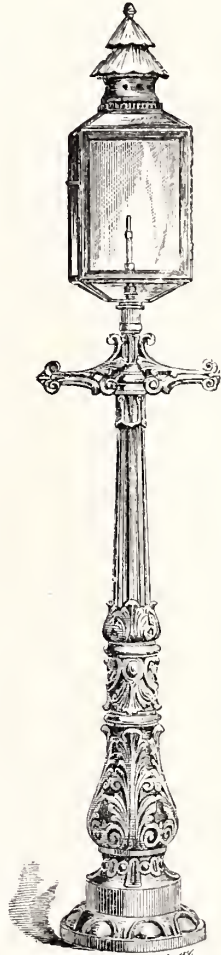

E 1100.

Diameter of Base12½ in.

Lamp, 25 in. high. Lamp, 9½ in. wide.

The Lamp, furnished with Bevel
Plate Glass, Tin Frame.....\$62 75
Polished Brass Frame..... 71 25

NEWEL POST AND PLAIN GLOBE.

With Brass Frame and Canopy.

FOR ANY INCANDESCENT SYSTEM.

Adjustable Clusters, Figs. E 472 and E 473, Two or Three-Light, can be arranged to fit this Lamp.

Globe and Canopy.....30 in. high.
 Diameter of Globe.....12 in.

Height of Post.....64 in.
 Base.....12 in. square.



E 1101.

Price, complete.....\$66.25

EUREKA LAMP AND POST.



E 1102.

Height of Post to bottom of Lamp, 8 feet.

Diameter at base of post, 10½ inches.

Price, complete, as shown.....	\$52 25
Post, less Lamp (1 coat paint)....	32 00
Lamp	20 25

NEWEL POST AND RUSHTON LAMP.



E 1103.

Height of Post to bottom of Lamp, 5 feet 7 inches.

Diameter at base of post, 10½ inches.

Height of Lamp, 2 feet 6 inches.

Complete.....	\$49 75
Post.....	24 50
Lamp.....	25 25

THREE-ARM CLUSTER POST.

With No. 2 Delmonico Lamps, Polished Brass Frame, Plate Glass (beveled).

FOR ANY INCANDESCENT SYSTEM.

Adjustable Clusters, Figs. E 472 and E 473. Two to Three-Light, can be arranged for these Lamps.



E 1104.

“RENAISSANCE.”

Height to bottom of center Lamp, 9 ft. 5 in. Base, 10½ in. square.

Price, complete, as shown, \$227.00. Price of Post, less Lamps (1 coat paint), \$75.00.

Price of Lamps, each \$50.75

BEACON LAMP.

FOR ANY INCANDESCENT SYSTEM.

Newel Post.

Adjustable Clusters, Figs. E 472 and E 473, Two or Three-Light, can be arranged to this Lamp.

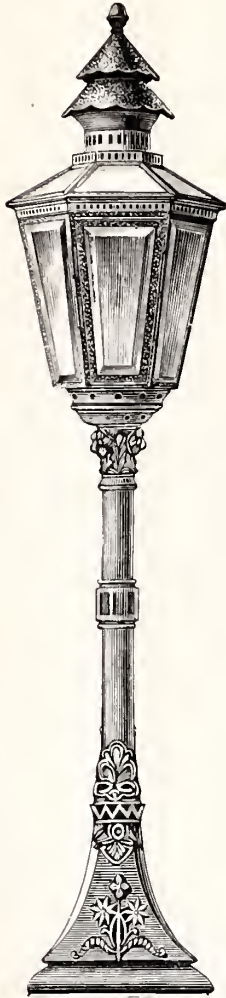

E 1105.

Polished Brass Frame, Beveled Plate Glass. Height of Post, 4 feet 1 in.

No. 1 Lamp and Post, complete as shown.....\$85 00.

	Height.	Width.	Price.
No. 1 Lamp.....	30 in.	15 in.....	\$50 00
No. 2 ".....	33 "	17 ".....	67 50
No. 3 ".....	36 "	19 ".....	76 00
Post, less Lamp.....			34 50

EUREKA LAMP.

FOR ANY INCANDESCENT SYSTEM.

Adjustable Clusters, Figs. E 472 and E 473, from Two to Six-Light, can be arranged to fit Lantern.



E 1106.

Height from bottom of Holder to top of Lamp, 36 in.

Diameter of Crown. 18 in.

Price\$20.25

The glass in the body of this Lamp is made in three parts, and can be slid in easily from the outside.

The glass in the top part of the Lamp is also in three pieces, and can be replaced by unscrewing and removing the metal top.

The advantage claimed for this Lamp is in its being made in sections, which renders it less likely to breakage from heat or expansion, and more easily repaired, and at less expense, in case of breakage from ANY cause.

It is a nice Cluster Lamp.

EUREKA LAMP, WITH BRACKET.

FOR ANY INCANDESCENT SYSTEM.

Adjustable Clusters, Figs. E 472 and E 473, from Two to Six-Light, can be arranged to fit Lantern.



E 1108.

Height from bottom of Holder to top of Lamp.....	36 in.
Diameter of crown.....	18 "
Stands out from wall.....	30 "
Price, complete.....	\$33.75

VESTIBULE GLOBE LAMP.*Cut Glass. Polished Brass Trimmings.*

FOR ANY INCANDESCENT SYSTEM.

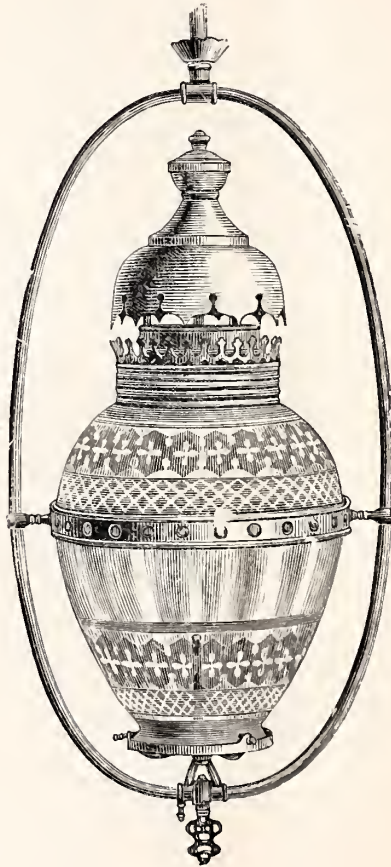
Adjustable Clusters, Figs. E 472 and E 473, can be arranged to fit this Lantern.

E 1110.

Height, 30 inches. Diameter, 15 inches

Price, complete.....\$30.50

COTTAGE LAMP.

FOR ANY INCANDESCENT SYSTEM.

Polished Brass Trimmings.

Adjustable Clusters, Figs. E 472 and E 473, can be arranged to fit Lantern.

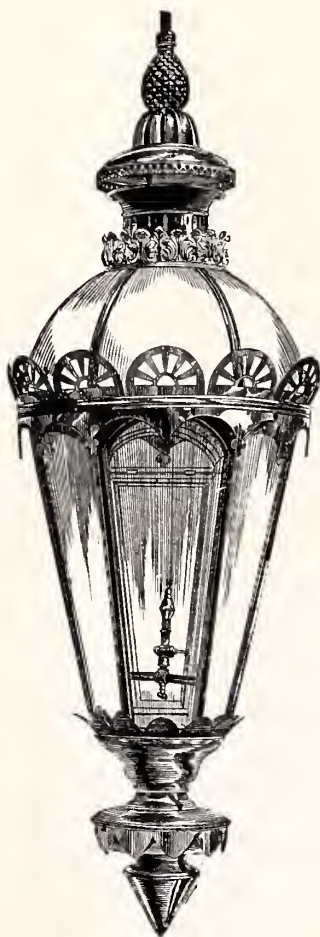

E 111.

16 in. wide, 45 in. high: price..... 350.00

IMPERIAL LAMP.

To Suspend. Polished Brass Trimmings.

FOR ANY INCANDESCENT SYSTEM.

Adjustable Clusters, Figs. E 472 and 473, from Two to Six-Light, can be arranged to fit Lanterns.



E 1112.

Height, 42 in.; diameter, 20 in.; price.....\$59.00

EMPIRE LAMP.

Patented March 11, 1884.

FOR ANY INCANDESCENT SYSTEM.

Adjustable Clusters, Figs. E 472 and E 473, from Two to Six-Light, can be arranged to fit Lantern.

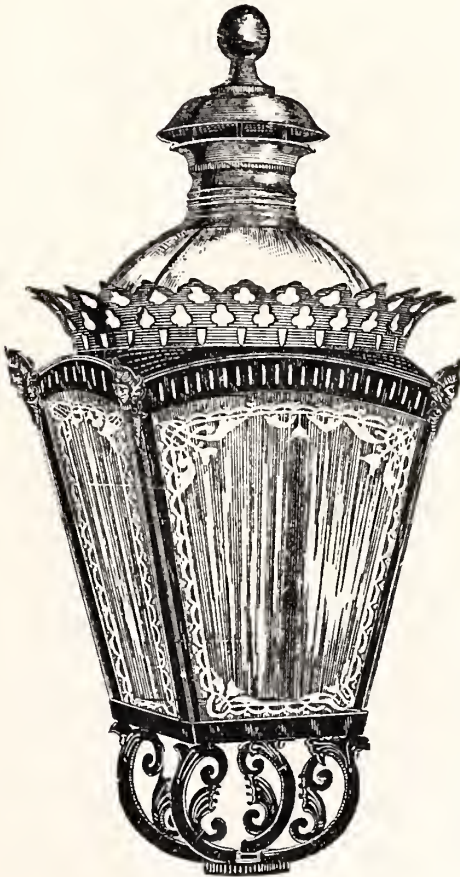

E 1113.

Height, from bottom of Holder to top of Lamp, 35 in.

Diameter of Crown, 18 in.

Price \$27.00

DELMONICO LAMP.

FOR ANY INCANDESCENT SYSTEM.

Adjustable Clusters, Figs. E 472 and E 473, from Two to Six-Light, can be arranged to fit Lantern.

With Beveled Plate Glass.

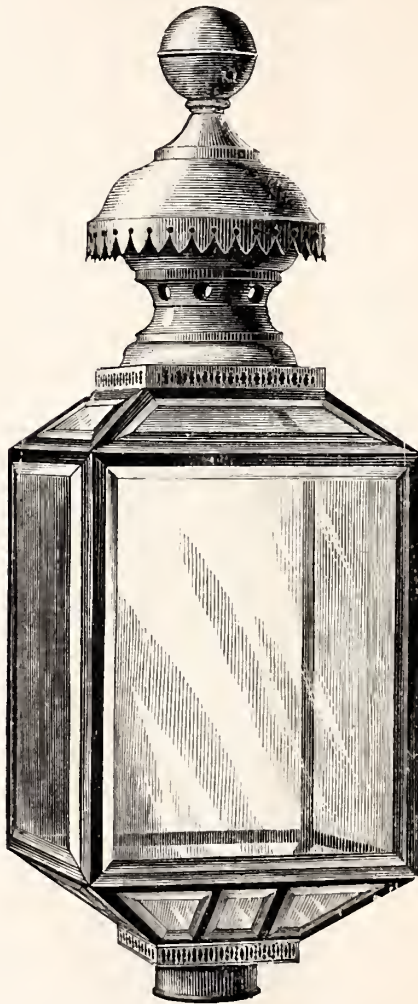

E 1115.

Height, 48 inches. Width, 19 inches.

No. 2.—	10½ inches wide,	31 inches high,	\$50 00
" 3.—	12½ " "	36 " "	76 00
" 4.—	14 " "	40 " "	84 50
" 5.—	16 " "	44 " "	109 75
" 6.—	19 " "	48 " "	126 50

FANCY OCTAGON LAMP.

FOR ANY INCANDESCENT SYSTEM.

Adjustable Clusters, Figs. E 472 and E 473, from Two to Six-Light, can be arranged to fit Lantern.

With Beveled Plate Glass.

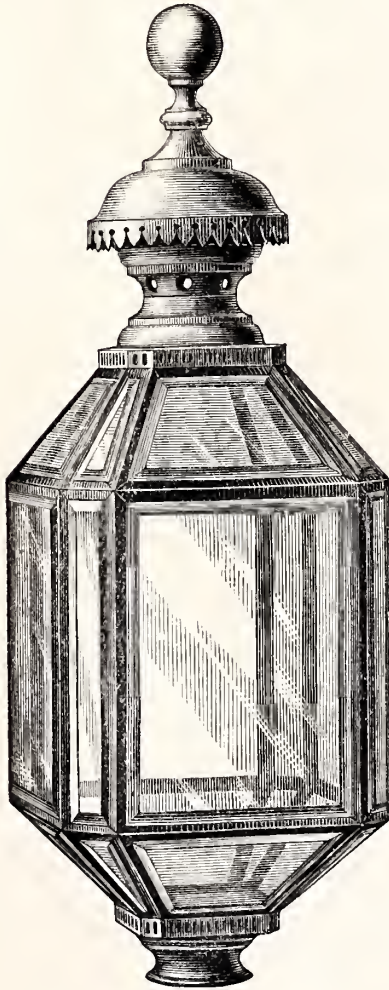

E 1116.

Height, 48 in. Width, 17 in.

Price.....\$135.00

SQUARE LAMP.

FOR ANY INCANDESCENT SYSTEM.

Dome Top.

Adjustable Clusters, Figs. E 472 and E 473, from Two to Six-Light, can be arranged to fit Lantern.

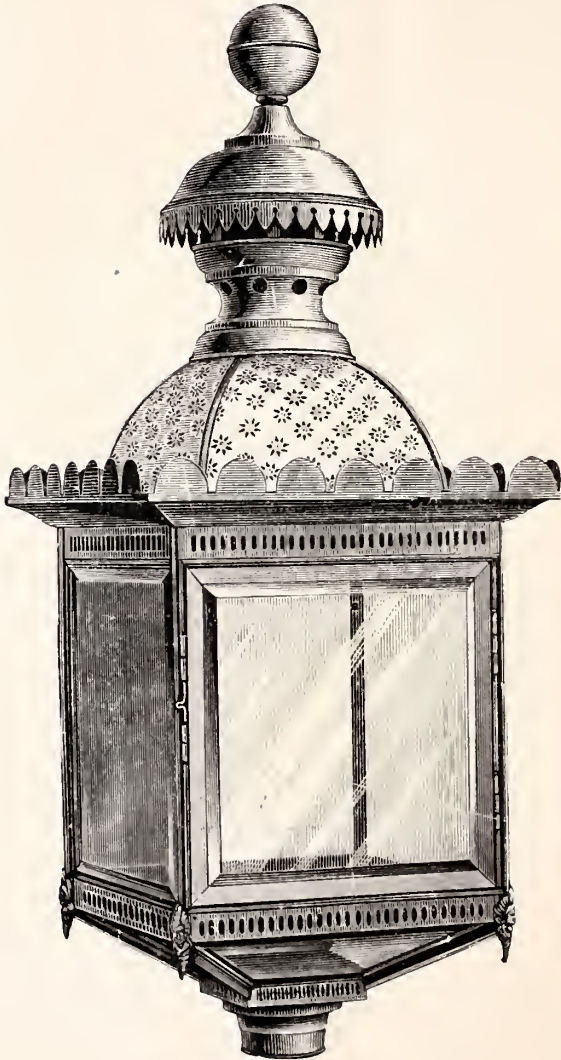

E 1117.

Polished Brass Frame, and French Beveled Plate Glass in body
and bottom : height, 50 in. : width, 19½ in. : price.....\$84.50

PRISMATIC LAMP AND BRACKET.

FOR ANY INCANDESCENT SYSTEM,

Adjustable Clusters, Figs. E 472 and E 473, can be arranged to fit Lamp.

Diameter, 12½ in. ; height, 28 in. ; length of Bracket, 15 in. Blue, green, old gold and crystal Tops. Price, complete \$26.25

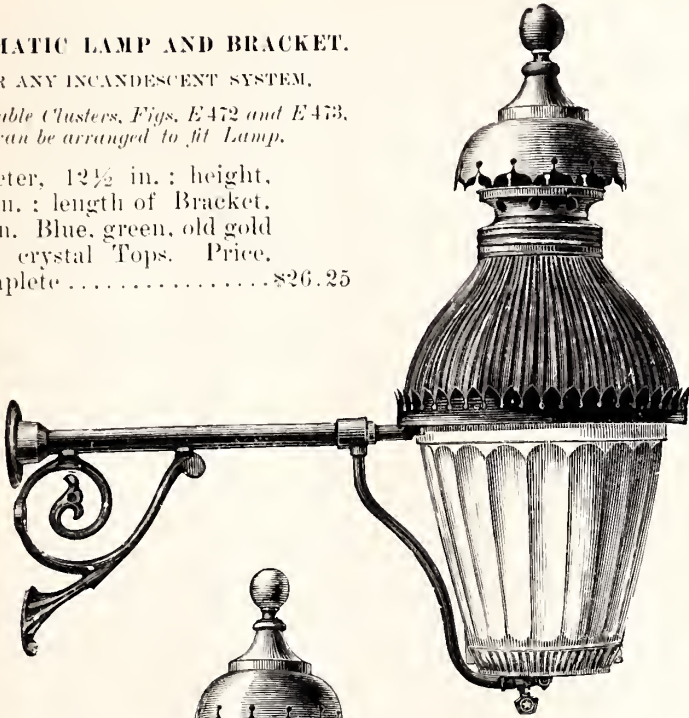

E 1118.

PRISMATIC LAMP FOR POST.

FOR ANY INCANDESCENT SYSTEM.



E 1119.

Adjustable Clusters, Figs. E 472 and E 473, can be arranged to fit Lamp.

Diameter, 12½ in. ; height, 28 in. Blue, green, old gold and crystal Tops. Price, complete \$20.25

CANOPY HALL LAMP.

FOR ANY INCANDESCENT SYSTEM.

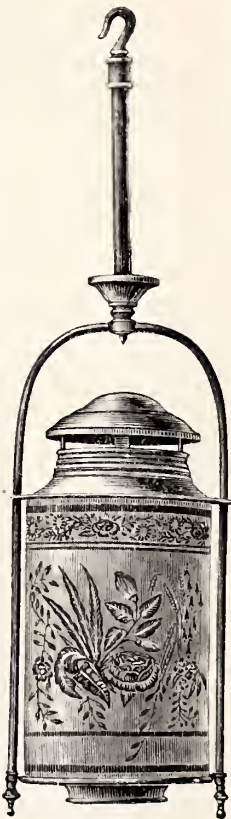
Adjustable Clusters, Figs. E 472 and E 473, can be arranged to fit this Lamp.

E 1120.

Price.....\$10.25

HALL LAMP.

FOR ANY INCANDESCENT SYSTEM.

Adjustable Clusters, Figs. E 472 and E 473, from Two to Six-Light, can be arranged to fit Lantern.

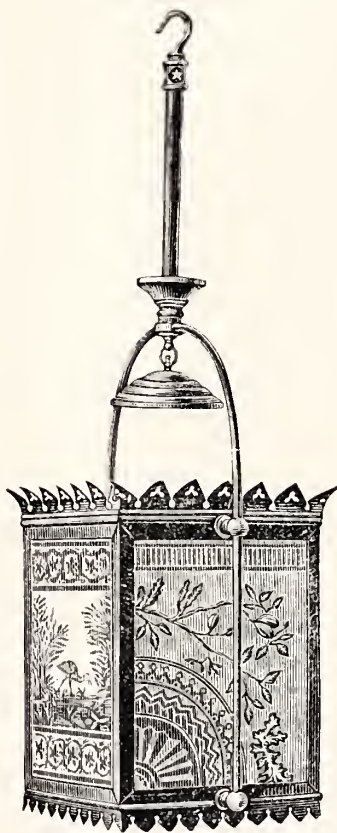

E 1121.

Width, 9 inches. Height, 13 inches.

Crystal, Etched Glass.....	\$18 50
Colored. " "	20 25
Beveled Plate "	20 25

HALL LAMP.

FOR ANY INCANDESCENT SYSTEM.

Open Top.

Adjustable Clusters, Figs. E 472 and E 473, from Two to Six-Light, can be arranged to fit Lantern.

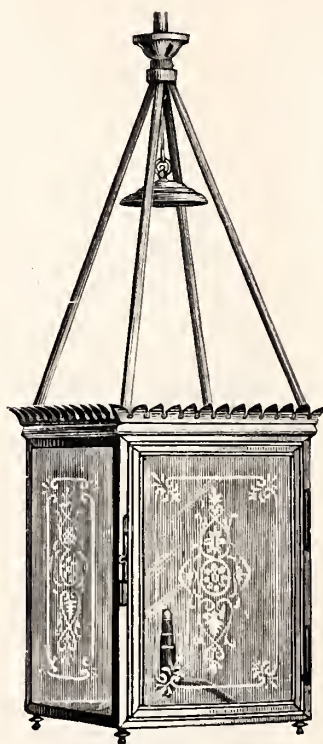

E 1122.

Height, 30 in. Width, 11 in.

Polished Brass Frame. Enameled Glass.

Price.....\$30.25

GROUND GLOBE.

FOR ANY INCANDESCENT SYSTEM.

With Holder and Canopy.



E 1123.

8-in., each.....	\$4 65		10-in., each.....	\$6 00
9 " "	5 00		12 " "	6 75

Same as Above.—With Holder and Fancy Canopy.



E 1124.

10-in., each.....	\$6 75		14-in., each.....	\$9 25
12 " "	7 25		16 " "	11 75

GROUND GLOBE, WITH HOLDER AND SPUN BRASS CANOPY.
 FOR ANY INCANDESCENT SYSTEM.

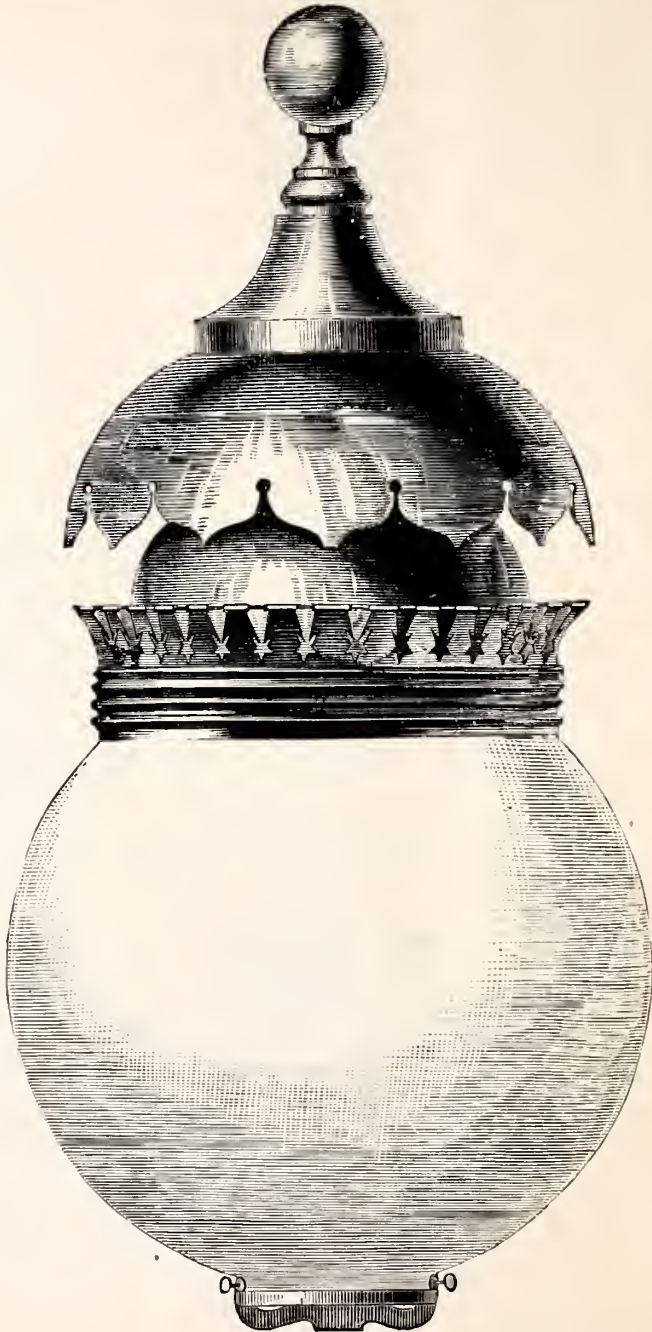

9-inch Globe.....	\$11 00	13-inch Globe	\$16 00
10 " "	12 75	16 " "	17 75
12 " "	14 25		

EGG GLOBE AND CANOPY.

To Suspend.

FOR ANY INCANDESCENT SYSTEM.



E 1126.

No. 1 :

Globe, 10 x 12 inches.

Harp, 13 x 20 "

Each.....\$10.00

No. 2 :

Globe, 12 x 14 inches.

Harp, 15 x 24 "

Each.....\$12.00

GLOBE AND CANOPY.

To Suspend.

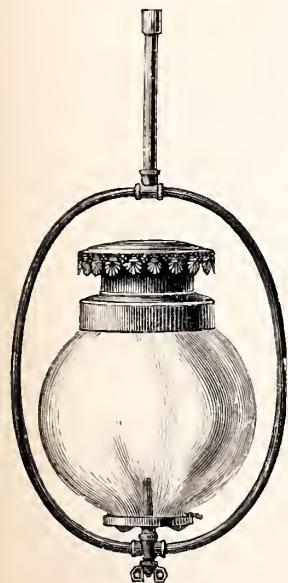

E 1127.

No. 1 :

Globe, 10 inches.

Harp, 13 x 20 inches.

Each.....\$9.75

No. 2 :

Globe, 12 inches.

Harp, 15 x 24 inches.

Each.....\$10.50



LITTLE McDONALD CUT OUT

IS a device for operating incandescent lamps on arc or multiple series circuit, so that the advantages of multiple arc systems are obtained without the accompanying defects of expensive wiring and limited distance.

The device is an automatic magnet with duplex action, which substitutes an equivalent for a lamp when broken or burned out, so as to maintain the equilibrium of the circuit. The principle of the magnetic switch is novel, and its contact is made firm and positive by a patented magnetic action. All other cut outs depend on springs or gravity to maintain contact, and a slight jar causes sparking, which corrodes the contact point and soon destroys the contact.

E. P. GLEASON M'F'G CO.,

SOLE AGENTS.

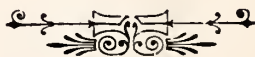

We show below the two systems in which the Little McDonald Cut Out is principally used.

Series Multiple
Incaudescant Lights on Arc
Cirents,
 WITH
LITTLE McDONALD CUT OUT.

SERIES MULTIPLE is shown in Fig. 1, and is convenient, as incandescant and arc lights may be run on the same circuit. The current divides between the incandescant lamps, giving each its proper current. No wall controller need be used, a simple switch sufficing to turn off the group when the lights are not needed. The wires may be run in any convenient manner, preserving the connections, as shown. Turn-offs are provided when desired, so that single lamps may be turned off or on at will.

Fig. 2.

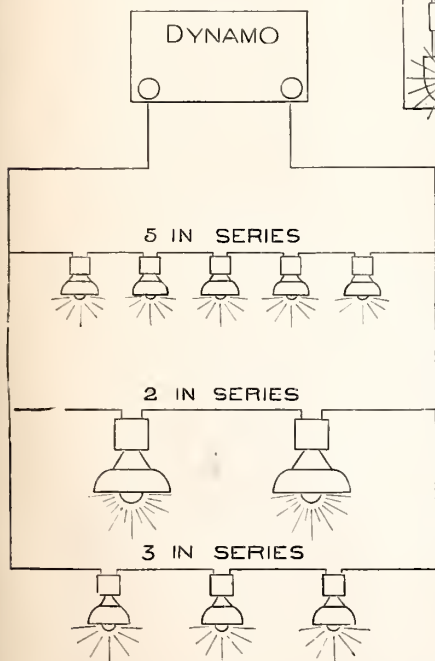
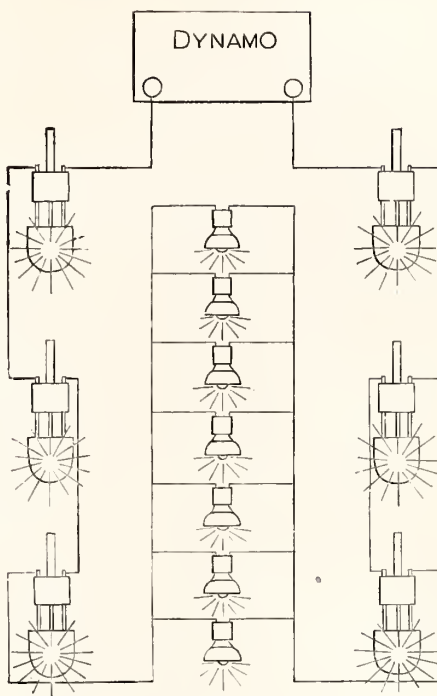

Fig. 1.



Multiple Series,
 WITH THE
LITTLE McDONALD CUT OUT.

MULTIPLE SERIES, shown in Fig. 2, requires a constant e. m. f., and sufficient quantity to supply the lamps in use. Lamps must be of such a number and resistance that each may get its proper e. m. f. If 350 volts be used, five lamps of 70 volts, three of 116 $\frac{2}{3}$ volts, or two of 175 volts may be used in a group. Without a Cut Out the failure of one lamp extinguishes the group. With the Cut Out the lamps may be placed in any convenient manner, and the failure of one will not affect the others. By using the Cut Out with turn-off, any lamp may be extinguished at will.

State System in use and Volts and Amperes when ordering.

STANDARD No. 1 LITTLE McDONALD CUT OUT.
(CUT SHOWING CONSTRUCTION.)

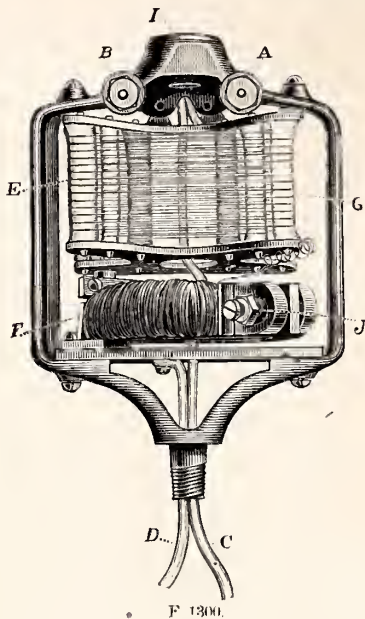

- A B—Binding screws for line wires.
- C D—Wires connecting to lampholder.
- E—Rheostat.
- F—Cut Out magnet.
- G—Frame.
- I—Hole in frame for line wires.
- J—Regulating screw.

Regulate by screw J and armature spring.

For lamps of 16 to 20 candle-power.
Price, each.....\$6.00

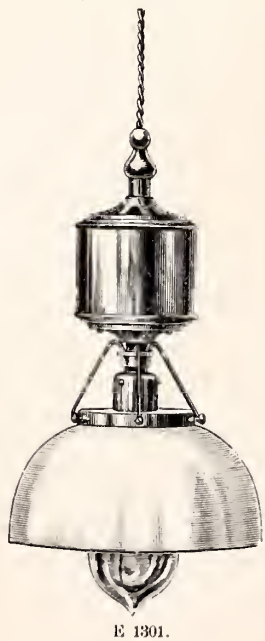

E 1301.
Length, 60 in.

Shows Standard No. 1 Cut Out as used directly over lamp on cord pendant.
Price, including Ceiling Rosette, complete, less Filament Lamp, each.....\$7.50



E 1302.
Length, 60 in.

Shows Standard No. 1 Cut Out rigidly attached to ceiling block, wired, ready to attach line wire to binding posts.
Price, complete, less Filament Lamp, each.....\$8.00

State System in use and Volts and Amperes when ordering.

THE COMET INCANDESCENT REFLECTOR.

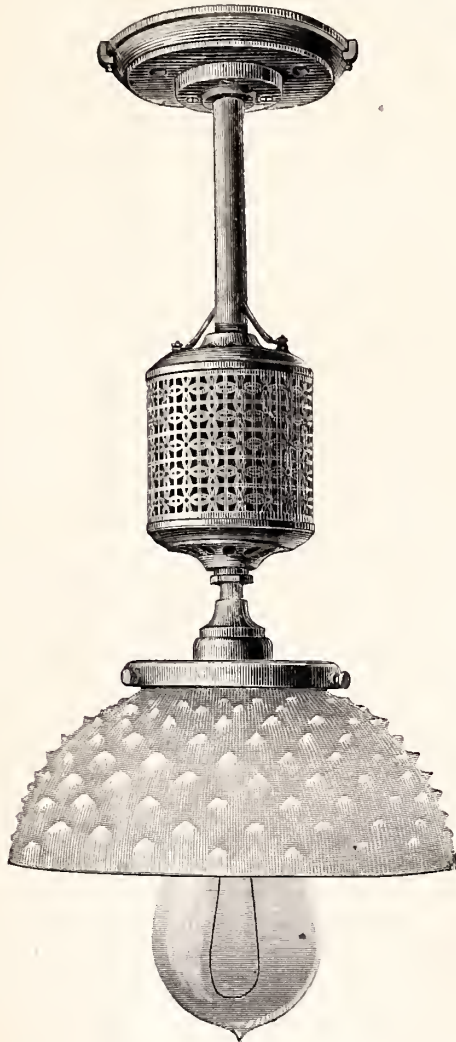

E 1333.

Length, 50 in. ; $\frac{3}{4}$ -iron stem, bronzed.

Price, complete, including 14-inch Opalescent Dome, No. 4 Little McDonald Cut Out, ceiling block, binding posts and large Filament Lamp, wired, each..... \$50.00

State system in use and Volts and Amperes when ordering.

The above cut represents our Comet Lamp, with 14-in. opalescent reflector and ceiling board, with binding posts, wired, complete, ready for attachment to arc circuit of any system.

It may be used in connection with our No. 1 Cut Outs of 100 Volts when a single large lamp is desired, or will run in groups of five in 10 Ampère circuits, or three in $6\frac{2}{10}$ Ampère circuits.

SILK-CORD PENDANT WITH "L" CUT OUT.

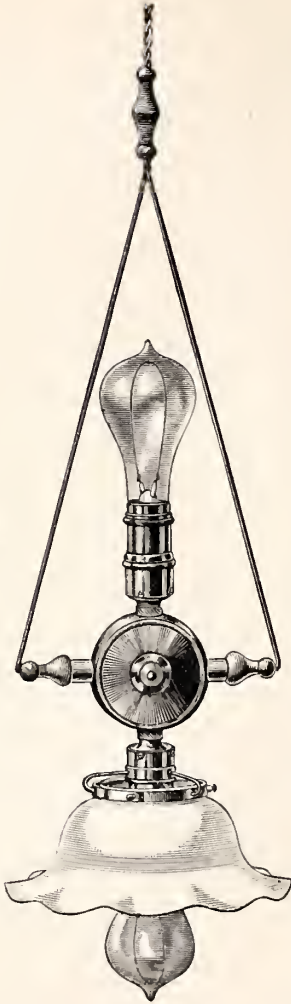

E 1304.

Length over all, 5 ft.

LITTLE McDONALD "L" CUT OUTS.

CAN BE USED ON ANY SYSTEM.

In ordering, state Voltage and Candle-power of Lamps in use.

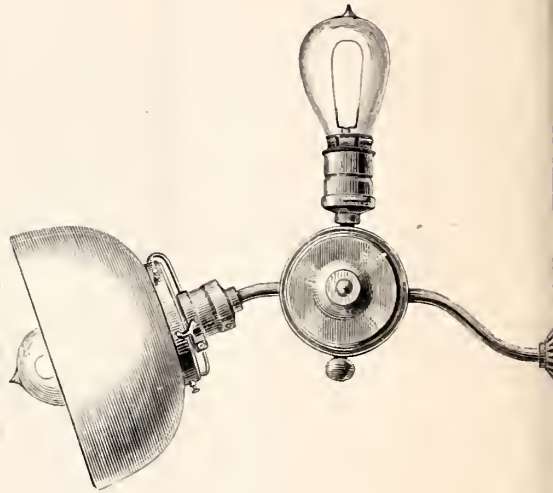

E 1305.

Bracket with "L" Cut Out.

Price, each, complete as shown, with Filament Lamps and Key Sockets \$13 50

Price, each, less Filament Lamps and Sockets 6 00

In the "L" Cut Out a lamp is substituted for a German-silver resistance. It is largely used for a night-light for stores, in Multiple-arc System, as the failure of one lamp does not cause a failure of light.

WITH CEILING ROSETTE BUTTON AND PLUGS.

..1.. Cut Out, Pendant Style, complete, with Key Sockets and Filament Lamps, each	\$13 50
..1.. Cut Out, Pendant Style, complete, less Key Sockets and Filament Lamps, each	6 00

