



This is a digital copy of a book that was preserved for generations on library shelves before it was carefully scanned by Google as part of a project to make the world's books discoverable online.

It has survived long enough for the copyright to expire and the book to enter the public domain. A public domain book is one that was never subject to copyright or whose legal copyright term has expired. Whether a book is in the public domain may vary country to country. Public domain books are our gateways to the past, representing a wealth of history, culture and knowledge that's often difficult to discover.

Marks, notations and other marginalia present in the original volume will appear in this file - a reminder of this book's long journey from the publisher to a library and finally to you.

### **Usage guidelines**

Google is proud to partner with libraries to digitize public domain materials and make them widely accessible. Public domain books belong to the public and we are merely their custodians. Nevertheless, this work is expensive, so in order to keep providing this resource, we have taken steps to prevent abuse by commercial parties, including placing technical restrictions on automated querying.

We also ask that you:

- + *Make non-commercial use of the files* We designed Google Book Search for use by individuals, and we request that you use these files for personal, non-commercial purposes.
- + *Refrain from automated querying* Do not send automated queries of any sort to Google's system: If you are conducting research on machine translation, optical character recognition or other areas where access to a large amount of text is helpful, please contact us. We encourage the use of public domain materials for these purposes and may be able to help.
- + *Maintain attribution* The Google "watermark" you see on each file is essential for informing people about this project and helping them find additional materials through Google Book Search. Please do not remove it.
- + *Keep it legal* Whatever your use, remember that you are responsible for ensuring that what you are doing is legal. Do not assume that just because we believe a book is in the public domain for users in the United States, that the work is also in the public domain for users in other countries. Whether a book is still in copyright varies from country to country, and we can't offer guidance on whether any specific use of any specific book is allowed. Please do not assume that a book's appearance in Google Book Search means it can be used in any manner anywhere in the world. Copyright infringement liability can be quite severe.

### **About Google Book Search**

Google's mission is to organize the world's information and to make it universally accessible and useful. Google Book Search helps readers discover the world's books while helping authors and publishers reach new audiences. You can search through the full text of this book on the web at <http://books.google.com/>

12  
1895

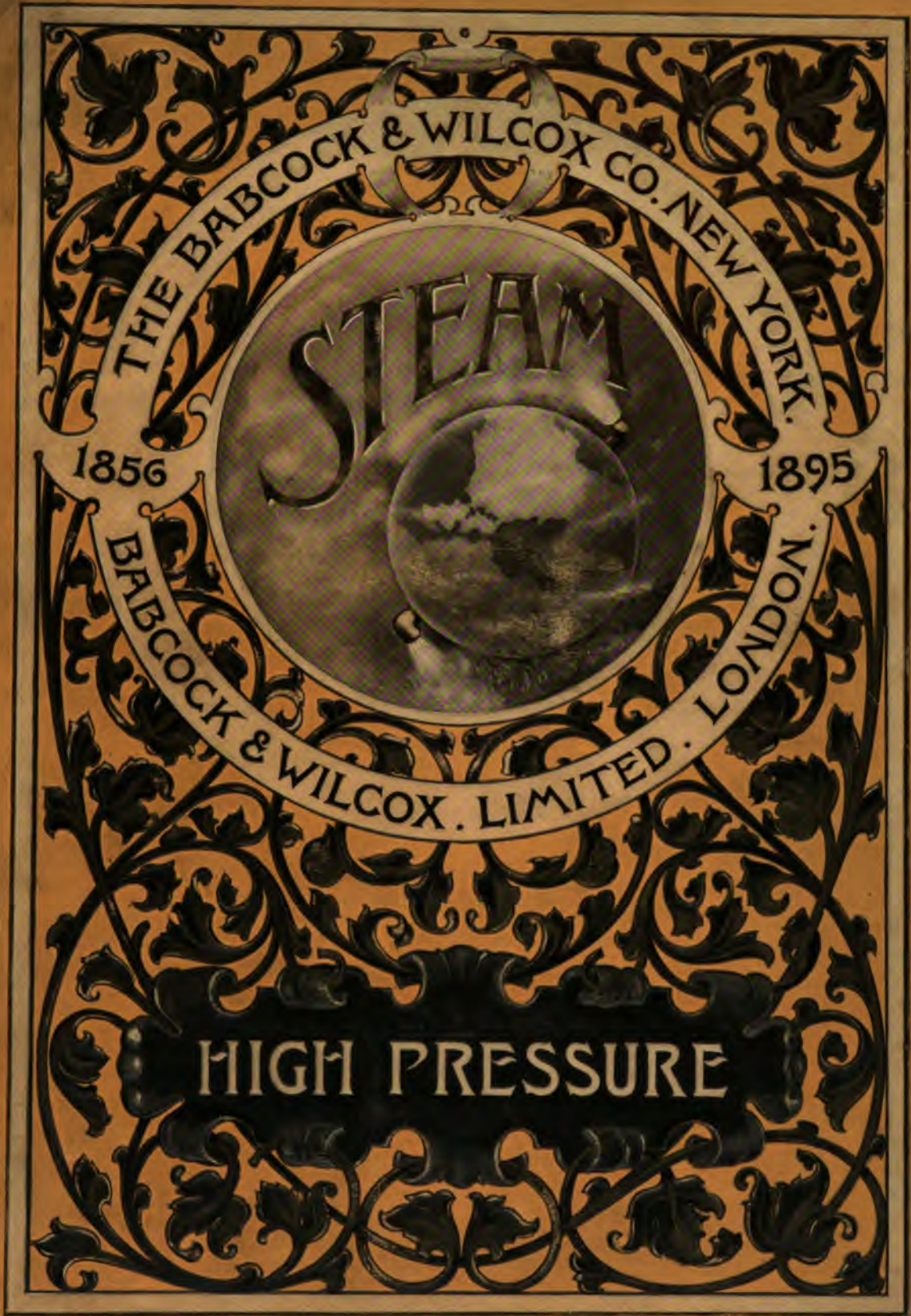

THE BABCOCK & WILCOX CO. NEW YORK.

1856

1895



BABCOCK & WILCOX. LIMITED. LONDON.

HIGH PRESSURE

University of Wisconsin

LIBRARY

Class THX  
Book B11  
H

**LIBRARY**  
— OF THE —  
**UNIVERSITY OF WISCONSIN**







# HIGH PRESSURE STEAM



THE BABCOCK & WILCOX CO.

29 CORTLANDT STREET, NEW YORK

AND

BABCOCK & WILCOX, LIMITED

147 QUEEN VICTORIA STREET, LONDON

---

NEW YORK AND LONDON

APRIL, 1895



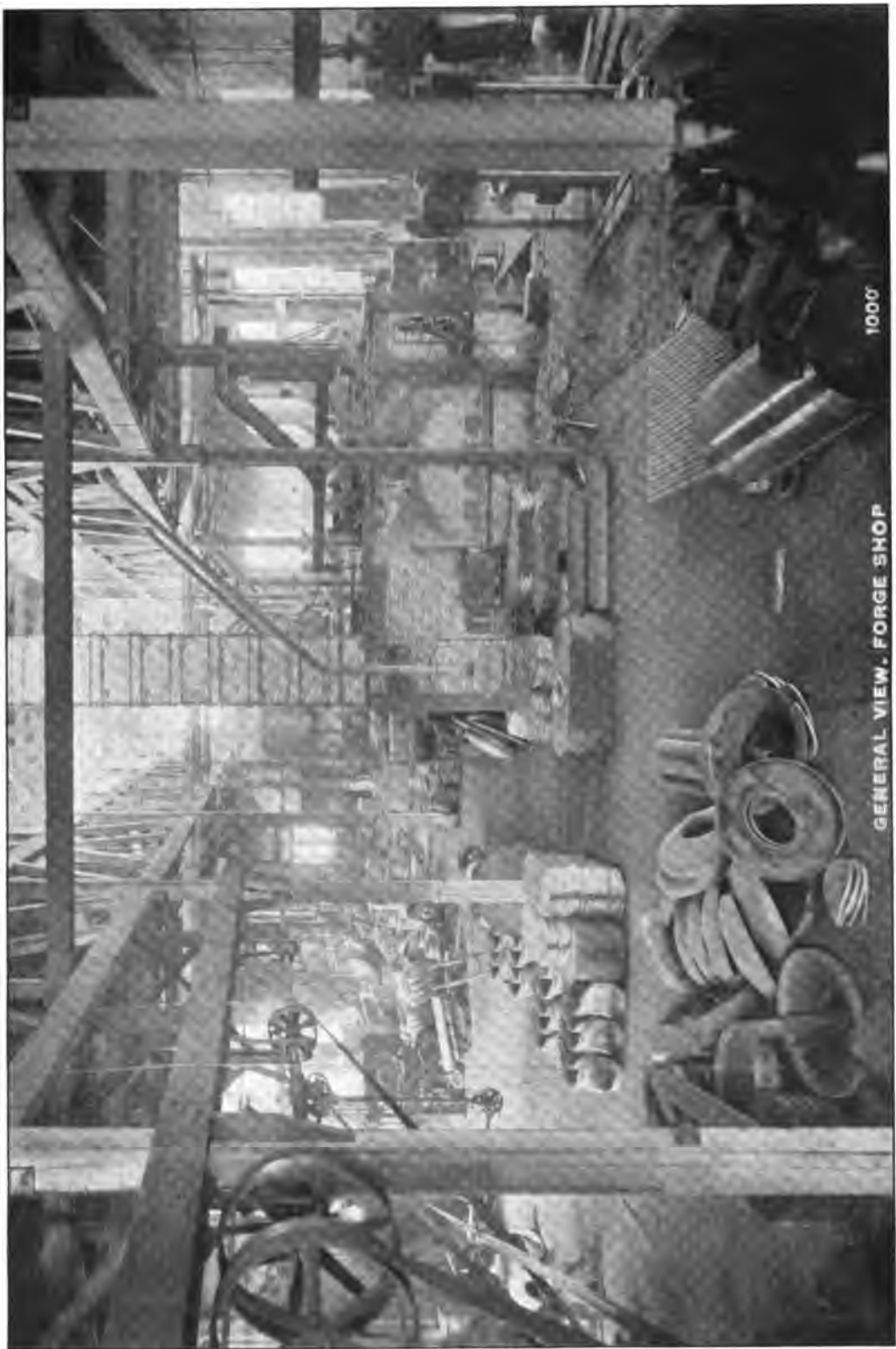

1000'

GENERAL VIEW, FORGE SHOP

T H N

.B 11

h

## HIGH PRESSURE STEAM.

WHILE all the manufacturing world have been investigating their scrap heaps, and in many instances making their profits out of by and waste products, economies in steam power have also received attention.

The necessity of reducing the cost has made imperative the steady rise in steam pressures that has been so marked in the last few years, and the same causes will force them still higher.

The governing factors having the greatest influence have undoubtedly been, primarily, to obtain decreased coal consumption, with its attendant economies in handling and storage, and, secondarily, the necessity of placing the greatest amount of power in a given space, to save in real estate investments and size of buildings.

For many years the pressures carried on locomotives in this country greatly exceeded those carried on stationary plants. It started at about 100 pounds, rose to 120 in 1860, to 150 in 1880, and at the present time as high as 180 pounds pressure is carried on compound locomotives.

The earlier stationary plants were mostly low pressure or condensing, and it was not until the advent of the high speed engine that pressures approaching locomotive practice were commonly adopted. In 1875 the pressures carried on the best class of stationary plants did not average over 65 pounds, in 1880 about 90 pounds, in 1890 about 125 pounds, and to-day pressures ranging from 185 to 250 pounds are not uncommon where the highest economy is required, driving compound, triple and quadruple expansion engines.

In this, as in many other lines of mechanical development, the large electric power plants have led the way. The

severe requirements of their service—demanding economy and absolute certainty of action, conjoined with sudden and enormous fluctuations of load, and the necessity at times of forcing every device to its utmost capacity—have given the engineering public a series of ideal practical tests, in which the value of high pressure for all power purposes has been amply proved.

The sectional water tube boiler has made possible this rise in pressure and consequent gain in economy, having superseded the shell boiler to a great extent. The most successful of those are based on the original design by Stephen Wilcox in 1856. This was the first water tube boiler with inclined tubes connecting water spaces at front and rear with an overhead steam and water reservoir lying horizontally and parallel with the tubes, and producing a continuous round of water circulation by a cross flow of furnace gases at right angles to the tubes.

The power plants of the Centennial Exhibition (1876) and the World's Fair (Chicago, 1893,) may be taken as fairly representative of the best boiler engineering of their time, and the special features of the boilers exhibited may be studied to advantage.



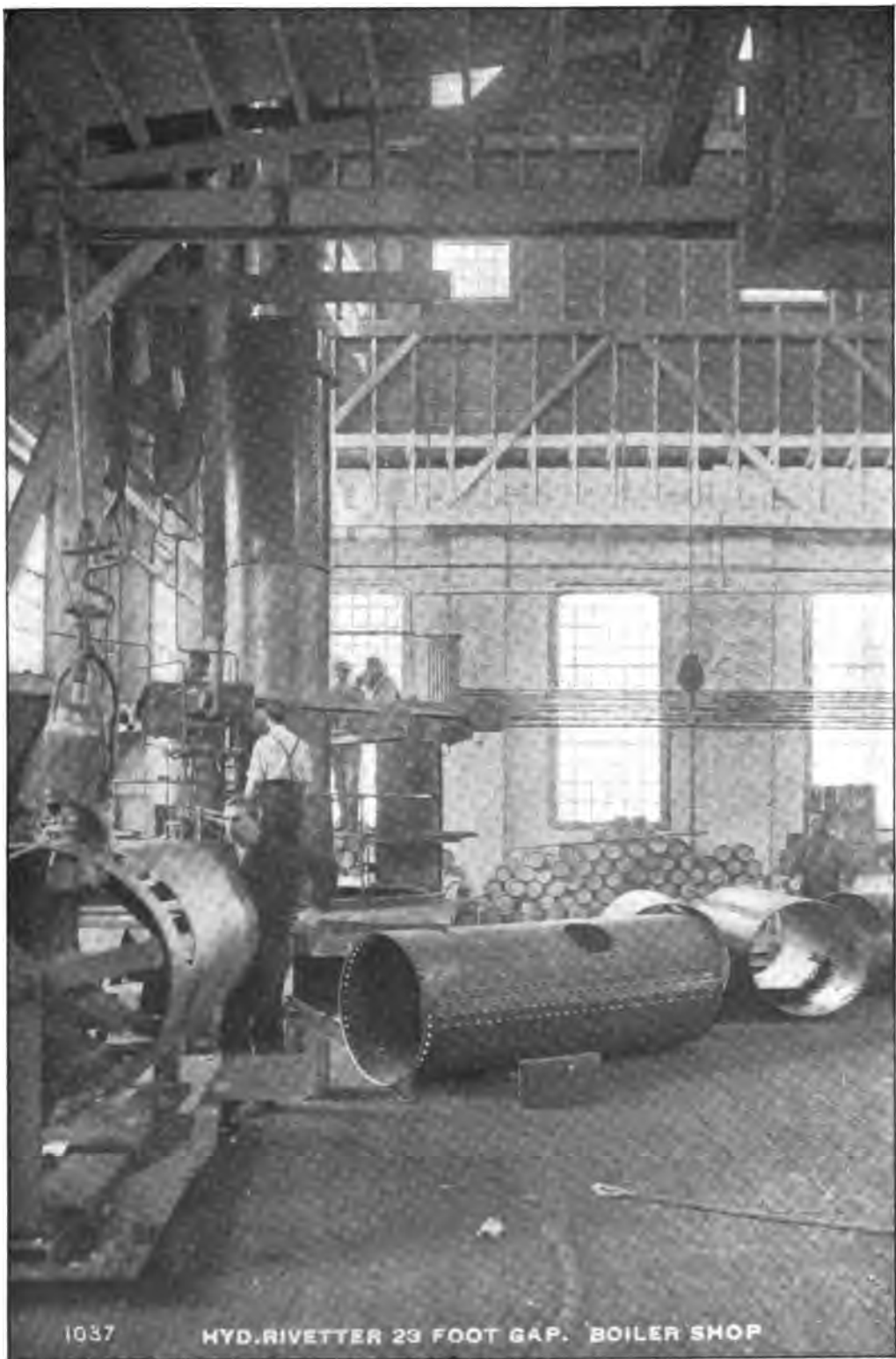

1037

HYD.RIVETTER 29 FOOT GAP. BOILER SHOP

## CENTENNIAL EXHIBIT, 1876.

At the Centennial Exhibition the power plant was made up of boilers that may be classified as follows, the horse-power being that obtained by tests :

### 1ST. SHELL BOILERS,

Having an aggregate horse-power in excess of all other styles combined, as follows :

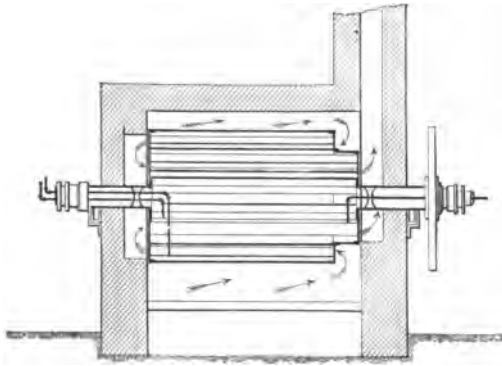

**PIERCE** (rotary) . . . . . 65 H.-P.

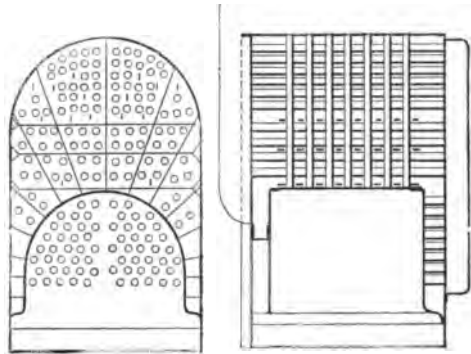

**ANDREWS** ("fire box") . . . 55 H.-P.

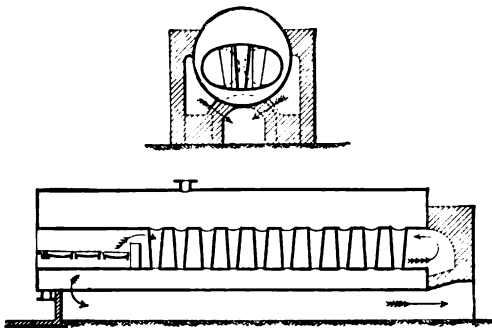

**GALLOWAY** . . . . . 127 H.-P.

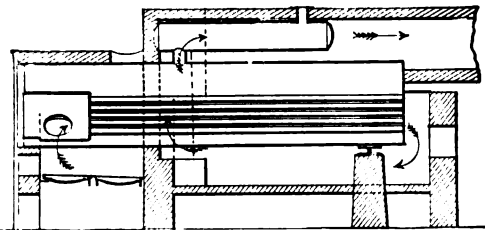

**LOWE** (return tubular) . . . 66 H.-P

<b>PIERCE</b> . . . . .	65 H.-P.	}	Total . . . . .	313 H.-P.
<b>ANDREWS</b> . . . . .	55 "			
<b>LOWE</b> . . . . .	66 "			
<b>GALLOWAY</b> . . . . .	127 "			

There were also twenty Corliss boilers, plain vertical tubulars, 4 feet diameter by 14 feet high, having a total of 13,000 square feet of heating surface. These were not tested.

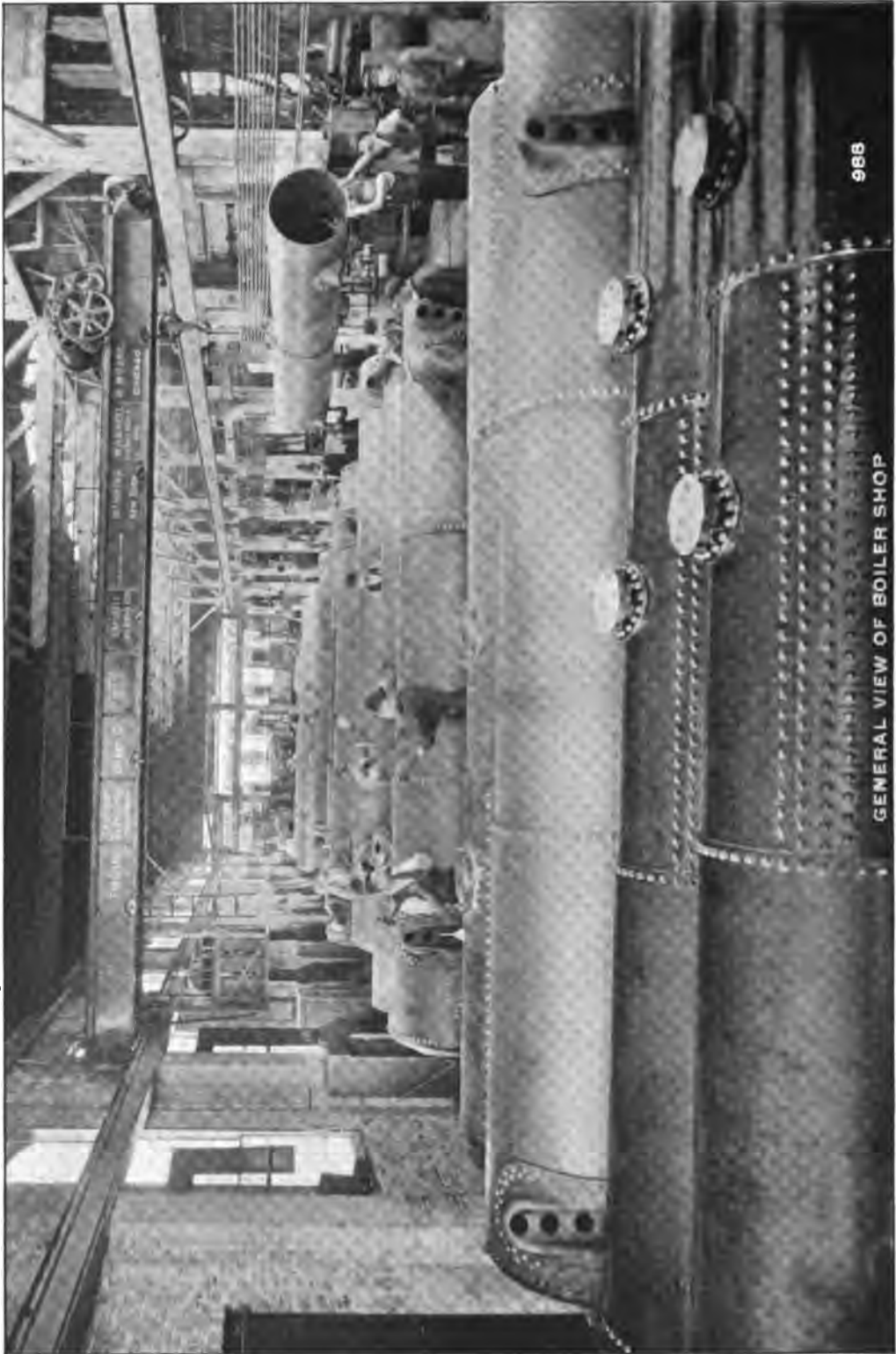

988

GENERAL VIEW OF BOILER SHOP

2D. CAST-METAL SECTIONAL BOILERS.

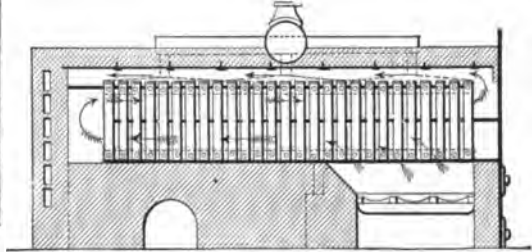
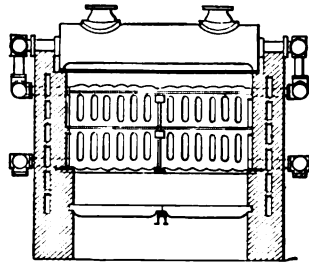
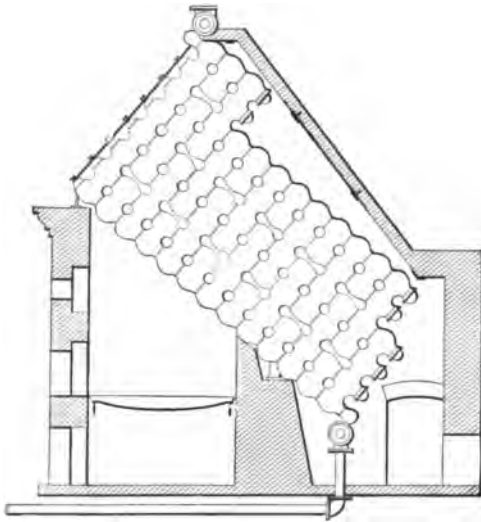

★ **HARRISON** . . . . . 105 H.-P.

**EXETER** . . . . . 87 H.-P.

★ **HARRISON** . . . . . 105 H.-P.

**EXETER** . . . . . 87 "

} Total . . . . . 192 H.-P.

3D. NON-SECTIONAL WATER TUBE BOILERS.

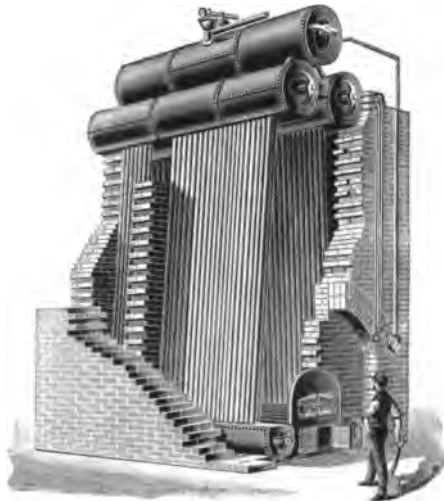

**FIRMENICH** . . . . . 65 H.-P.

**ROGERS & BLACK** . . . . . 63 H.-P.

**FIRMENICH** . . . . . 65 H.-P.

**ROGERS & BLACK** 63 "

} Total . . . . . 128 H.-P.

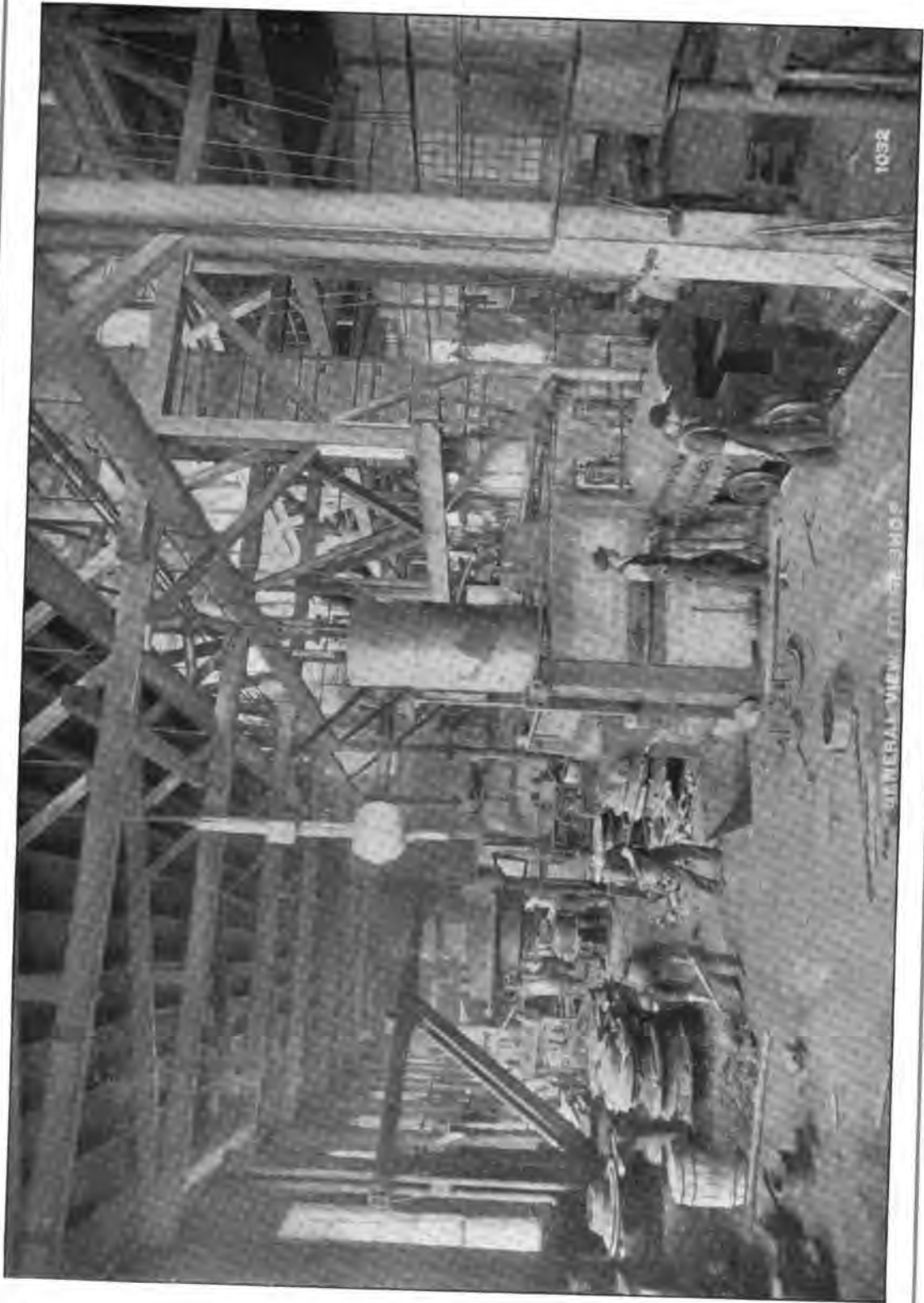

1032

GENERAL VIEW OF THE WORKSHOP



4TH. SECTIONAL WATER TUBE BOILERS.

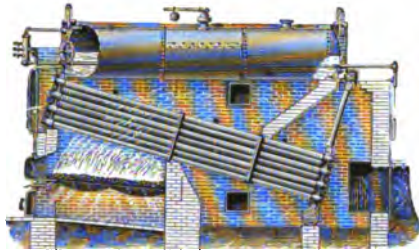

**BABCOCK & WILCOX** . . . 178 H.-P.

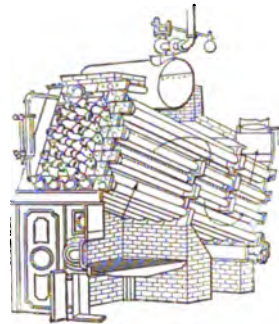

★**ROOT** . . . . . 140 H.-P.

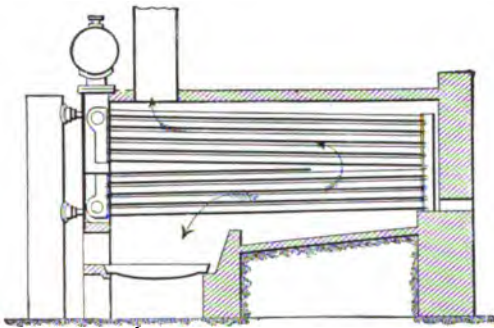

**ANDERSON** . . . . . 126 H.-P.

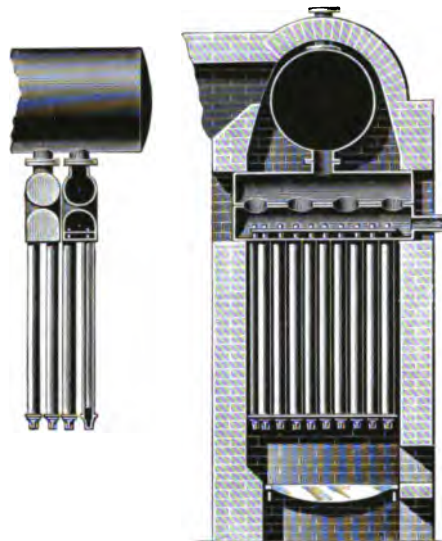

**WIEGAND** . . . . . 156 H.-P.

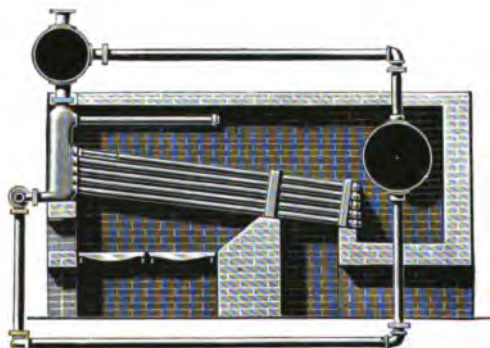

**KELLY** . . . . . 96 H.-P.

<b>BABCOCK &amp; WILCOX</b>	178 H.-P.
<b>ANDERSON</b>	126 "
<b>KELLY</b>	96 "
★ <b>ROOT</b>	140 "
<b>WIEGAND</b>	156 "
Total	696 "

Making a total power plant, Corliss not included, of 1369 H.-P.





1016

DRUM STORAGE - MAIN TRACK -

## WHAT HAS BEEN THEIR RECORD SINCE?

Those marked with a dash are no longer built; those marked with a star ★ are no longer built as then exhibited.

In the Harrison boiler the particular disposition of the units of heating surface in relation to the fire has been changed.

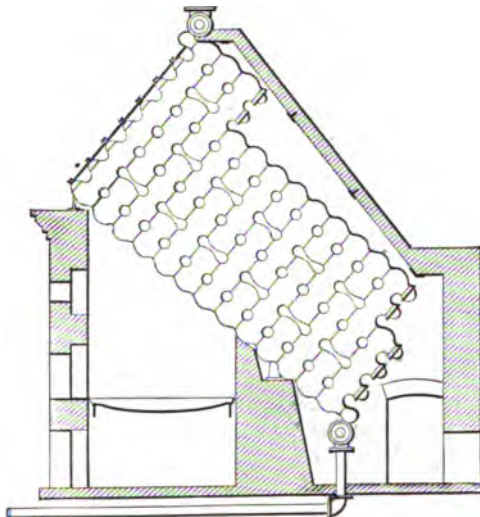

**HARRISON** (1876).

The Root boiler has been changed from a cross steam drum connected to the front end of a bank of tubes having an internal circulation within the bank,

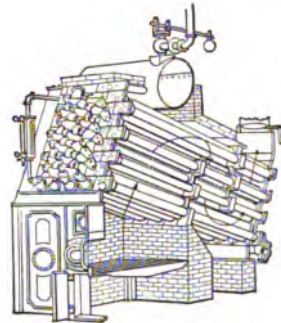

**ROOT** (1876).

to a steam and water drum running parallel with the tubes, connected to the front and rear end of the bank of tubes, the circulation running through it, embodying the Wilcox circulation.

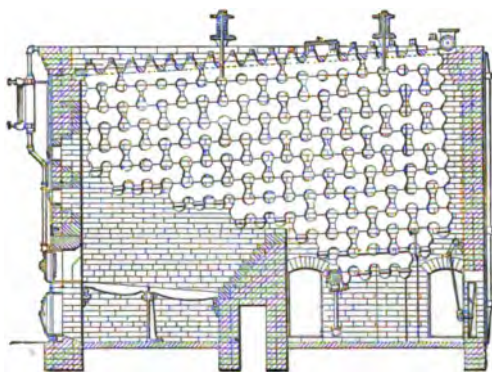

**HARRISON** (1893).

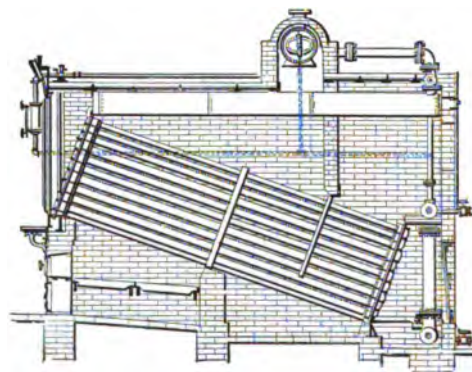

**ROOT** (1893).

This leaves three shell boilers fitted to carry low pressure, the Lowe, the Galloway and the Corliss, and one sectional high pressure boiler, the Babcock & Wilcox, as the only ones that have survived the test of time as then built, except in some minor details of construction.

It is well to note that both the *non-sectional* water tube boilers, the Firmenich and Rogers & Black, were abandoned; also that the *cast-metal* sectional boilers proved failures for power purposes and have been practically abandoned.

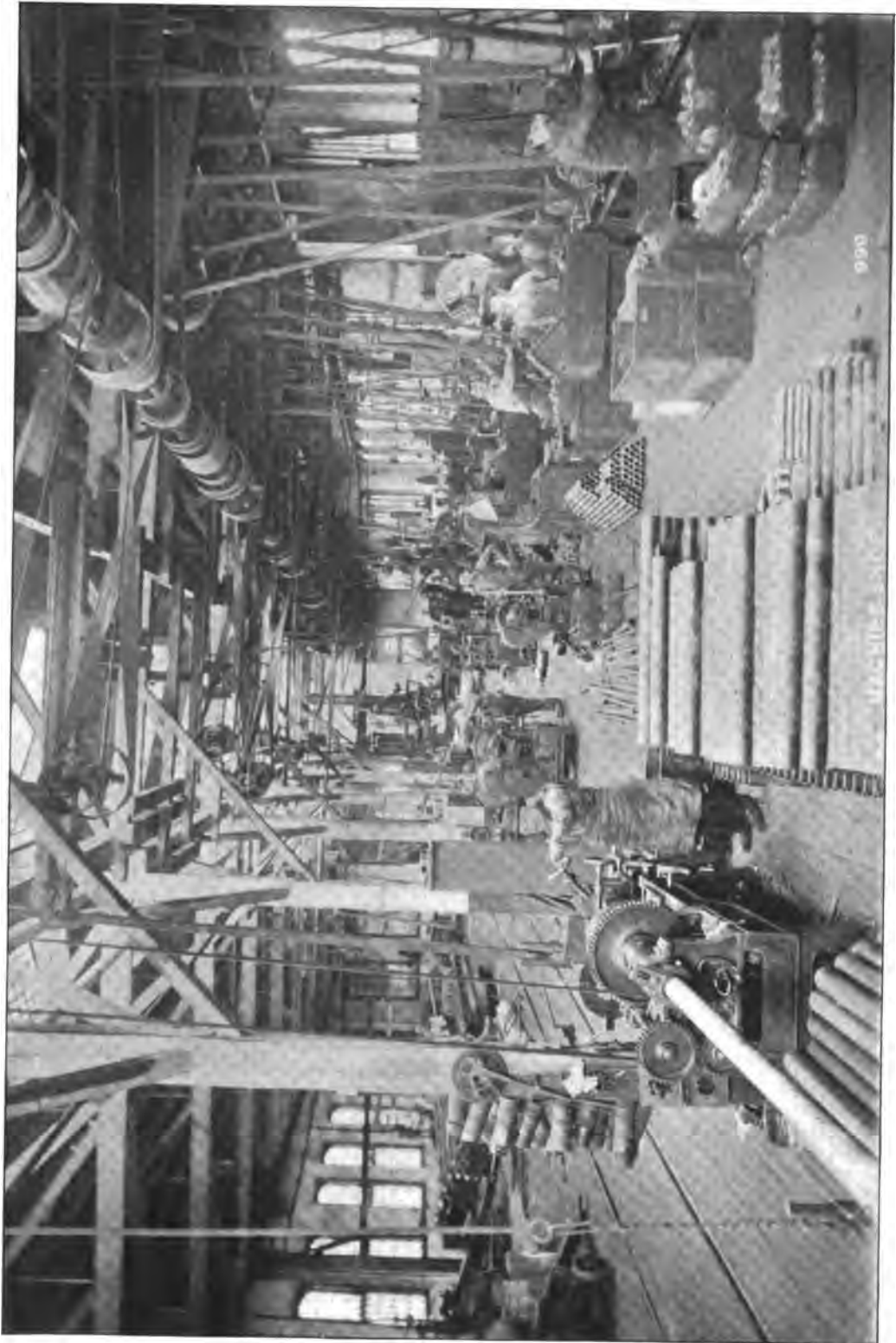

## WORLD'S FAIR, CHICAGO, 1893.

At the World's Fair, in Chicago (1893), there was 19,700 horse-power used in the power plant.

Based on the evaporation that they were contracted to deliver (30 pounds of water per horse-power from 100 degrees feed into steam at 70 pounds pressure) there were the following:

### SECTIONAL WATER TUBE BOILERS.

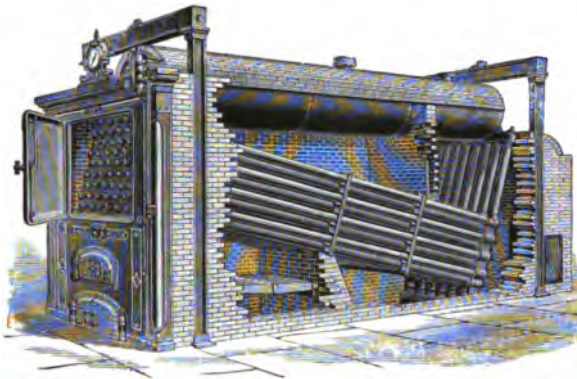

**BABCOCK & WILCOX** . . . . 3000 H.-P.

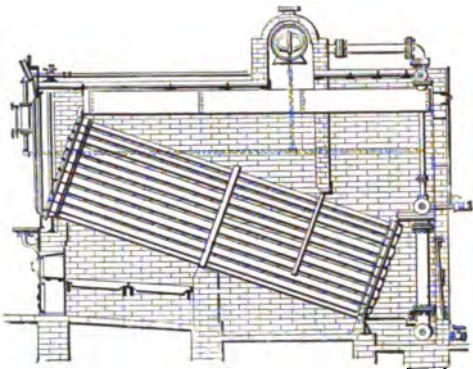

**ROOT** . . . . . 1500 H.-P.

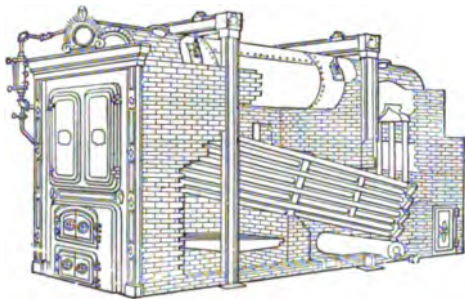

**NATIONAL (KELLY)** . . 1500 H.-P.

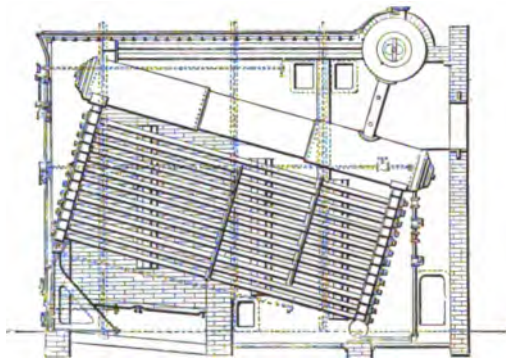

**ZELL** . . . . . 3750 H.-P.

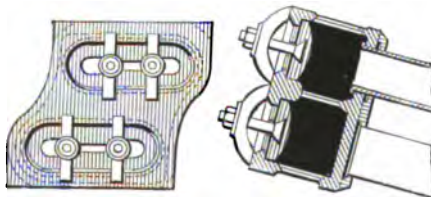

**ZELL HEADERS.**



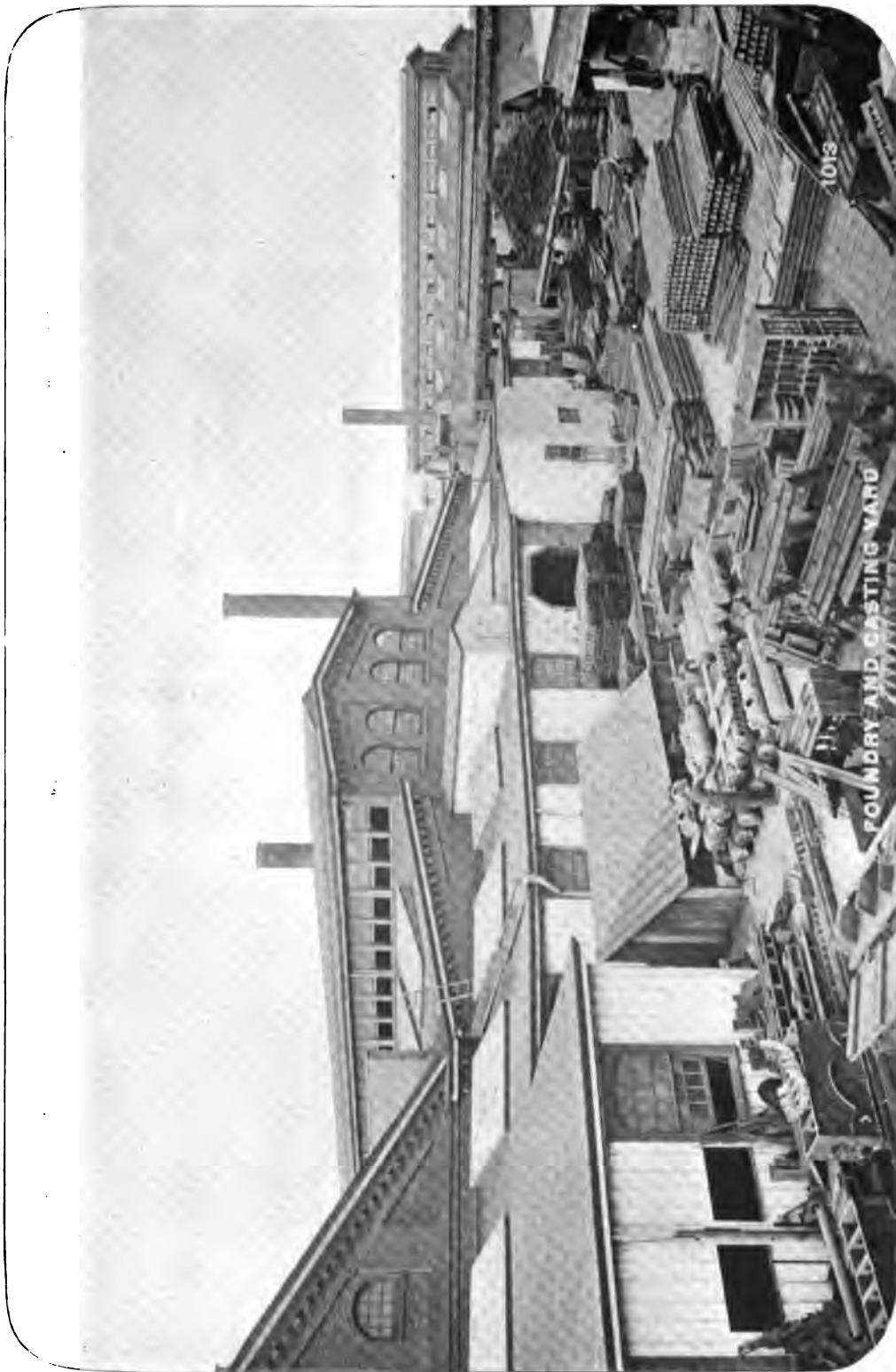

FOUNDRY AND CASTING YARD

1013

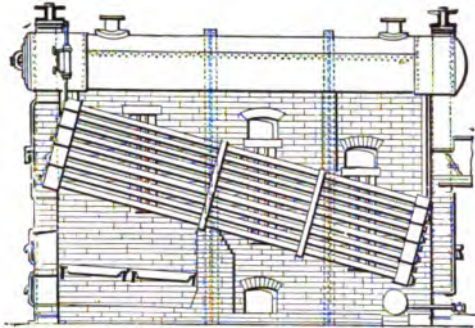

GILL . . . . . 1500 H.-P.

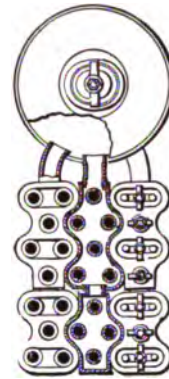

GILL HEADERS.

<b>BABCOCK &amp; WILCOX</b>	3000 H.-P.	}	Total . . . . . 11,250 H.-P.
<b>ROOT</b>	1500 "		
<b>GILL</b>	1500 "		
<b>NATIONAL</b>	1500 "		
<b>CAMPBELL &amp; ZELL</b>	3750 "		

Making a total of 11,250 H.-P. of sectional water tube boilers, all of which were based on the principles of the Wilcox patent of 1856.

At the Centennial the Babcock & Wilcox exhibit was the *only* boiler embodying the Wilcox principle.

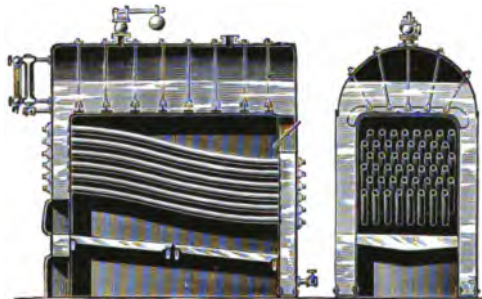

WILCOX DESIGN (1856)



083

GENERAL VIEW OF SHOPS FROM N.E.

## NON-SECTIONAL WATER TUBE BOILERS.

Of the non-sectional water tube type there were 3750 horse-power of Heine boilers (with stayed water legs) being a modified form of Maynard's design of 1870.

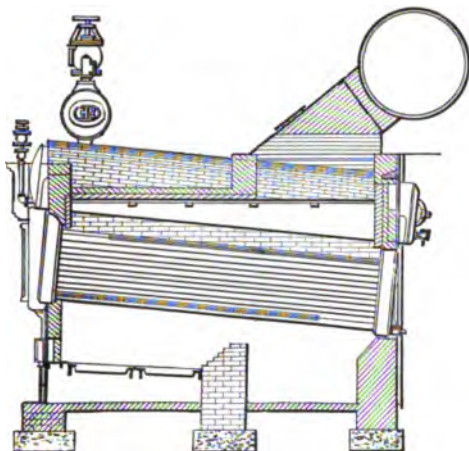

**HEINE** (1893).

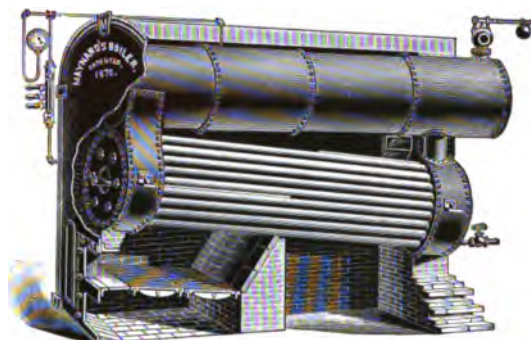

**MAYNARD** (1870).

Also 2700 horse-power of Stirling boilers (a modified form of Firmenich's exhibit at the Centennial in 1876).

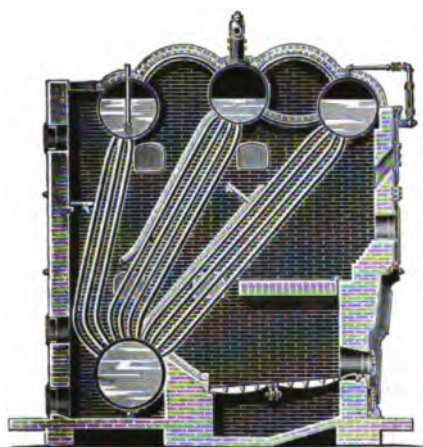

**STIRLING** (1893).

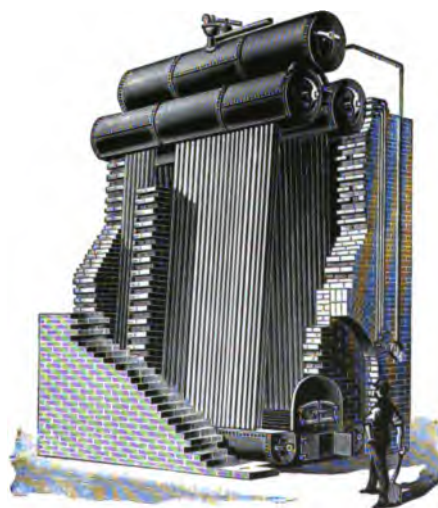

**FIRMENICH** (1876).



Also 2000 horse-power of Climax or Morrin boilers (a modification of Rogers & Black's bent-tube Centennial exhibit of 1876).

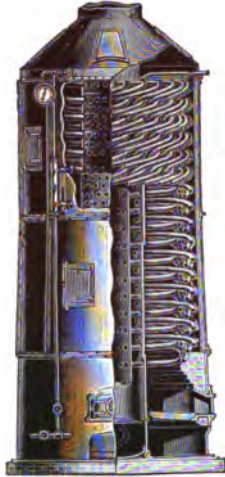

**CLIMAX** (1893).



**ROGERS & BLACK** (1876).

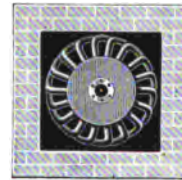
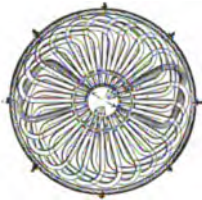

The three last-mentioned boilers, the Heine, Stirling and Climax, must all be classed as non-sectional water tube boilers.

Not a single example of the shell boiler was exhibited under pressure in the power plant.

It is due to the developments embodied in the World's Fair exhibit in 1893 that pressures of about 125 pounds are common in first-class steam plants. By them the sectional principle, as in contradistinction to the *non-sectional water tube* and shell boilers, has been demonstrated to be the best and most available for obtaining the maximum of economy and safety, and minimum of depreciation in ability to carry high pressures and in cost of repairs.

But as in the past the shell boiler and boilers having stayed surfaces reached their limit of comparative safety at about 100 pounds, and were superseded by the sectional type, so have the ordinary forms of sectional water tube boilers using cast-metal parts reached their limit of absolutely safe *endurance* at about 125 pounds, and still the demand for higher pressures is forced upon the manufacturer by the competitive calls for better economy and higher evaporative duty per square foot of heating surface.

The present demands are such that to produce a safe and satisfactory high pressure boiler, every item of "boiler-maker's" work must be discarded—the engineer and machinist must take his

place. Brains, high-grade materials and close mechanical fits must supersede rule of thumb, stays and drift pin engineering.

It is not enough to build a boiler that will just barely carry the pressure required when the plant starts up, but it must be able to carry this pressure for a long term of years, and, if necessary, to carry any reasonable increase in load that the balance of the plant will also carry. This is an absolutely necessary requirement, otherwise some local or insurance inspection is liable at any time to cut the pressure down to a point where the engines cannot give either their best economy or deliver the required capacity. The owners should command the situation and be able to demand an increase of pressure instead of being forced to submit to a reduction.

For high pressures, boilers with shells of large diameter, whether internally or externally fired, are no longer admissible. Their deterioration under heavy strains is too rapid to warrant the danger of running them.

The same may be said of any construction depending on stays. The latter are simply a substitution of brute force for skill in designing. They are generally so placed that inspection is impossible, and if any one of the hundred or more used in an ordinary size boiler is defective, either through flaws in the material, improper workmanship or corrosion, the structure is dangerous. In fact, the large stayed surfaces of some classes of boilers can only be viewed as aggregations of possible defects.

The next stage in high pressure development, the non-sectional water tube boiler, must also be discarded. As a class they have been failures, and all possess grave structural defects. All of those made up of bent tubes, and some

of them made of straight, cannot be cleaned. No matter what their original efficiency and economy, due to this one defect, they contain the certain elements of self-destruction following close on the heels of extravagant fuel bills and frequent repairs.

No provision is made in the non-sectional water tube boiler for correcting the defects and decay that are inseparable from all human constructions. Material, design and workmanship may all be good, but they may not. Some hidden defect is developed in service, is caused by low water or lack of cleaning, and then comes repairs.

On a non-sectional boiler repairs mean patches. Even the casual renewal of tubes in tube sheets of large area, or a drum full of holes, means the stretching of the holes and the overstraining of the metal, unfitting it for high pressures and making it as a whole defective; it becomes a chain with a weak link no longer fitted to carry the strain that the balance of the structure is amply strong to withstand. Patch it again? No. Adopt the one form that avoids such difficulties—the sectional water tube boiler. Make it not only so it can be cleaned, but cleaned and inspected from the outside, not by a workman squeezed through a manhole working away in the dark, hidden from the eye of the superintendent inside of a drum where he cannot or will not go. Build it up of units that can be removed when defective and replaced by others, leaving it as perfect as when new.

For high pressures—and they must be used or economy cannot be obtained—avoid cast metal in pressure parts; avoid its uncertainties and lack of strength. Use wrought-steel.

Such are the logical conclusions to which the steam user must arrive if in

studying the progress of the past he is to benefit himself by actual experience obtained at infinite cost and effort.

Such are the conclusions of the manufacturers of the Babcock & Wilcox boiler, based on actual experience covering twenty-seven years, with over one and a half millions of horse-power of the boilers running under every conceivable condition.

The Babcock & Wilcox Company, acting strictly on the lines of their past success, based on the belief that there is always a market for the best that can be made, have brought the sectional type to its present perfection, adopting

as their standard a wrought-steel sectional boiler built for any desired pressure. The drums, drum heads, man-hole plates and flanged connections, the cross boxes and headers into which the tubes are expanded, and all their hand-hole fittings, are hydraulic forged out of the best open hearth steel, every piece being annealed after forging. The fittings are designed and tested especially for long and continuous service at high pressure.

They invite attention to the annexed detail specification on which all bids are made, and to the cuts of their various shops indicating their facilities for filling orders.



NAT. W. PRATT, *Pres.*  
E. H. BENNETT, *Dir. Genl.*

**The Babcock & Wilcox Co.**

J. G. WARD, *Treasurer*  
C. A. MILLER, *Secretary*

**WATER TUBE STEAM BOILERS.**

Cable Address  
NEW YORK: "GLOBEBOILER"  
ALL POWERFUL OFFICES: "BABCOCK"

**NEW YORK**  
29 Cortlandt St.

BOSTON, 18 Oliver Street  
PHILADELPHIA, 22 1/2 S. 3<sup>rd</sup> St.  
BUFFALO, N.Y., Erie Co. Savings Bank Bldg.  
PITTSBURGH, Carnegie Bldg.  
NEW ORLEANS, 339 Canard St.  
SAN FRANCISCO, Fort & Serrano Sts.



CHICAGO, 310 Michigan Temple  
CINCINNATI, O., 308 Vine Bldg.  
MINNEAPOLIS, 604 First Exchange  
ST. LOUIS, MO., 317 Security Bldg.  
HAWAII, CUBA, 1115 Calle de la Habana  
MONTREAL, CANADA, 415 Board of Trade Bldg.

SPECIFICATION  
No.

NEW YORK, ..... 1895.

WE PROPOSE TO FURNISH TO

OFFICE

HORSE-POWER  
AND  
ARRANGEMENT

### H.-P. WROUGHT-STEEL SECTIONAL BOILERS.

(1 H.-P.—30 LBS. OF WATER EVAPORATED PER HOUR FROM 100 DEGREES  
AT 70 LBS. PRESSURE.)

HAVING A TOTAL OF        SQUARE FEET OF HEATING SURFACE  
AND        SQUARE FEET OF GRATE SURFACE.

ARRANGED TO BE SET        BOILER IN        BATTERY.

AS PER THE FOLLOWING SPECIFICATION.

HEATING  
SURFACES

The heating surface of each boiler to consist of  
steam and water drum        inches in diameter and        feet  
inches long, placed above and connected to a set of  
sections of tubes, each section consisting of        tubes,  
inches in diameter and        feet long. The lower ends of the  
sections to be connected to a mud-drum. The connections  
between all parts to be made by expanding wrought tubes  
into bored tube seats.

## WROUGHT-STEEL.

### SPECIFICATION OF OPEN HEARTH STEEL.

All wrought-metal for pressure parts, except tubes, to be of the best open hearth steel, having a tensile strength of from 56,000 to 62,000 pounds per square inch, to show an elongation of not less than 25 per cent. in a parallel test piece of 8 inches, accompanied by a reduction in area of at least 50 per cent. ; to endure bending double upon itself both before and after being brought to a flanging heat and quenched.

### FORGINGS.

All forgings for pressure parts to be made of the above steel by hydraulic presses and annealed after completion.



## DRUM CONSTRUCTION.

### THICKNESS OF SHEETS.

### RIVET SEAMS.

The cylindrical portion of the drum to be made of three sheets, each inch thick, the longitudinal seams butt-straped inside and out. The seams to have two rows of rivets passing through both straps and the shell, and two rows through the shell and inner strap only, the butt straps to be bent to a proper radius in a hydraulic press. The circular seams lap-joint, single riveted. The edges of all plates to be planed.

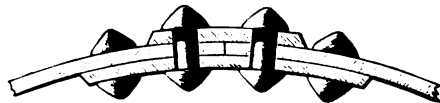

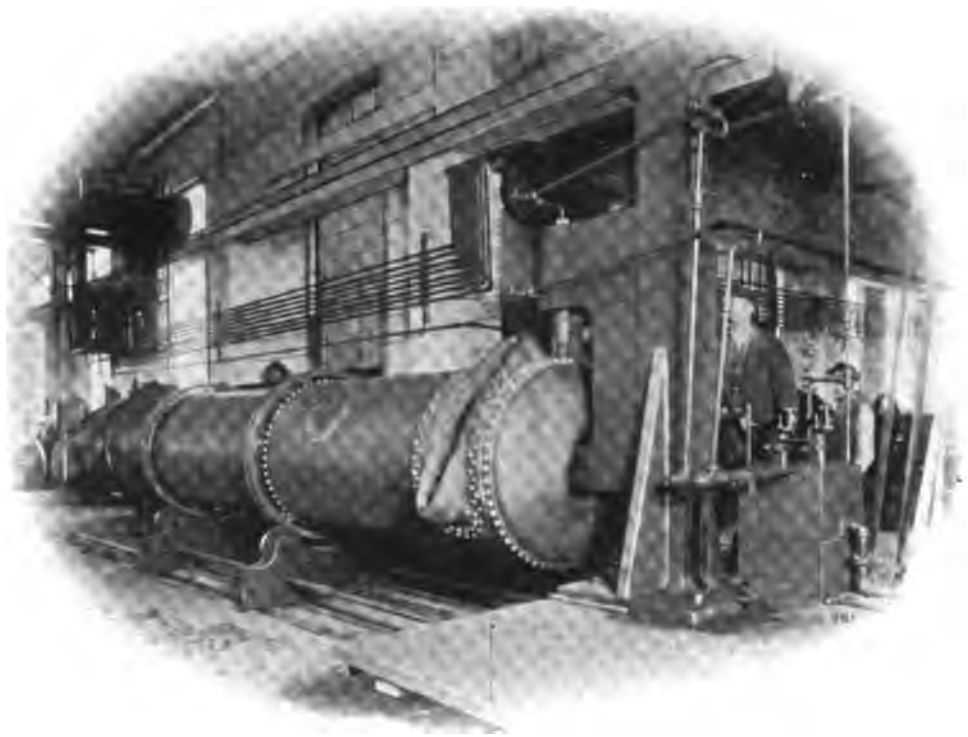

FITTING UP.

All holes to be punched  $\frac{1}{8}$  inch smaller than the diameter of rivets to be used, through steel templates, and drilled out to full size after the sheets are rolled and assembled with their butt-straps.

After drilling, the straps are to be removed, all burrs cleaned off, and the plates assembled, metal to metal, with parallel turned bolts fitting the holes before riveting.

ASSEMBLING.

Each course to be built independently to template. The various courses and their heads to be assembled by a hydraulic forcing press, at a pressure of not less than 12 tons.



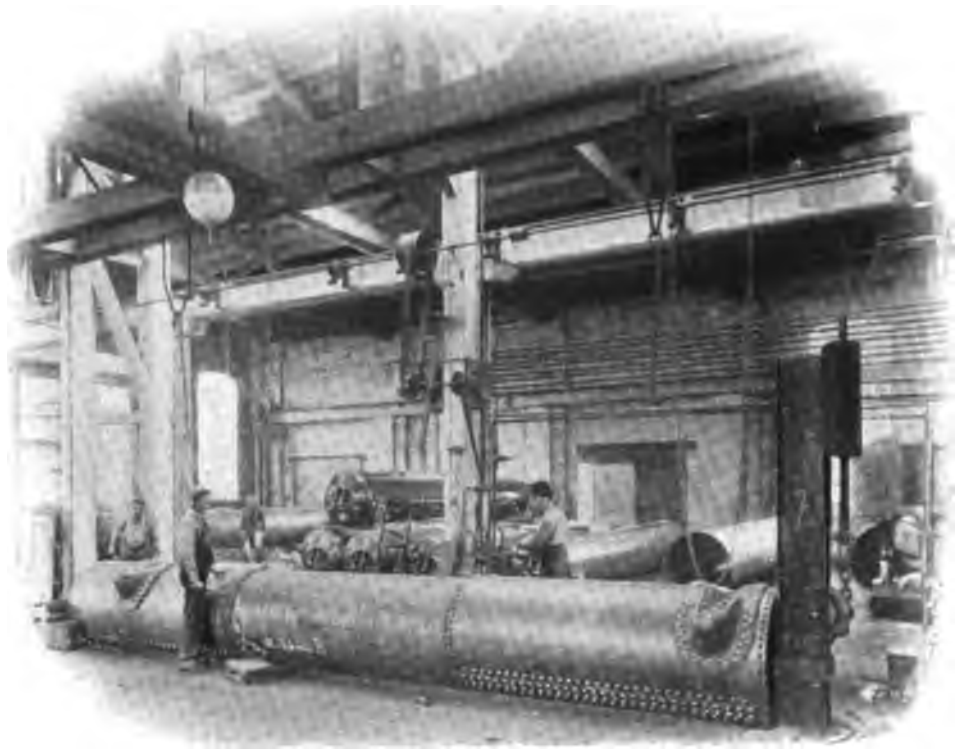

RIVET  
PRESSURE.  
DRUM HEADS.

All rivets to be driven with 60 tons pressure and held until cool.

All drum-heads to be fitted with manholes. The heads to be hydraulic forged at a single heat, with manhole ring and stiffening plate in position, and to have flat raised seats for stand pipe and feed connections. The edges of head and manhole face to be turned off true.





**MANHOLE FITTINGS.**

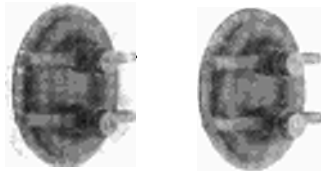

The manhole plate and guards to be of forged steel. The nuts case hardened. The plate, 11 inches by 15 inches, to be faced and turned to a true oval to fit head.

**STEAM FLANGES.**

The steam flanges, inches by inches diameter, of forged steel, recessed to make a male and female joint, fitted with stud bolts, with taper threads and inside keeper nuts; outside nuts case hardened.

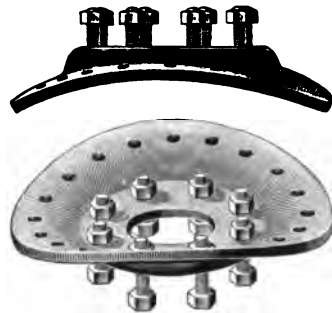

**CROSS BOXES.**

The drum cross boxes to be hydraulic forged from a single sheet without seams or rivets.







TUBE SHEDS.

## SECTIONS.

### TUBES.

The sections to be built up of 4-inch tubes made of the best knobbed, hammered charcoal iron blooms, of standard weight, and of such quality that a 1-inch section shall, when subjected to three blows from a 1500-pound hammer dropped five feet, be crushed into itself without showing cracks or flaws.



### HEADERS.

The tubes to be expanded into forged steel headers of serpentine form, disposing the tubes in a staggered position when assembled in the furnace.



**HAND-HOLES.**

A hand-hole of sufficient size to permit the cleaning, removal and renewal of a tube to be placed opposite each tube end, said hand-hole to have a raised seat milled off to a true surface.

**HAND-HOLE FITTINGS.**

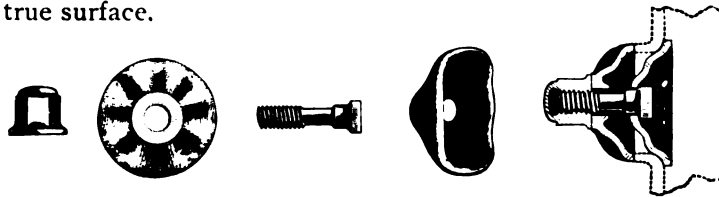

The hand-holes to be closed on the outside by a forged steel cap milled to a true surface, and to be held in position by a forged steel safety clamp, closing the hand-hole opening from the inside, secured by a ball-headed bolt to insure correct alignment, and a forged cap nut. All joints to be made tight, metal to metal, without packing of any kind.



**MUD-DRUMS.**

**BLOW-OFF.**

To be 12 inches diameter and of proper width to be connected with all of the sections in the boiler by means of wrought nipples expanded into counterbored seats. To be tapped for blow-off connections on its rear side, and furnished

**HAND-HOLES.**

with hand-holes for cleaning. The hand-hole plates to be faced and cap nuts to be used for hand-hole bolts, to avoid sticking from outside corrosion.

The mud-drums to be of best car-wheel mixture charcoal cold blast iron, tested to 400 pounds pressure.

**SUPPORTS.**

The boiler to be suspended, at front and rear, from wrought-iron supporting frames, entirely independent of the setting, to allow for contraction and expansion without straining either the boiler or the brick work, and to allow of repairs or renewal of the latter without disturbing the boiler or its connections.

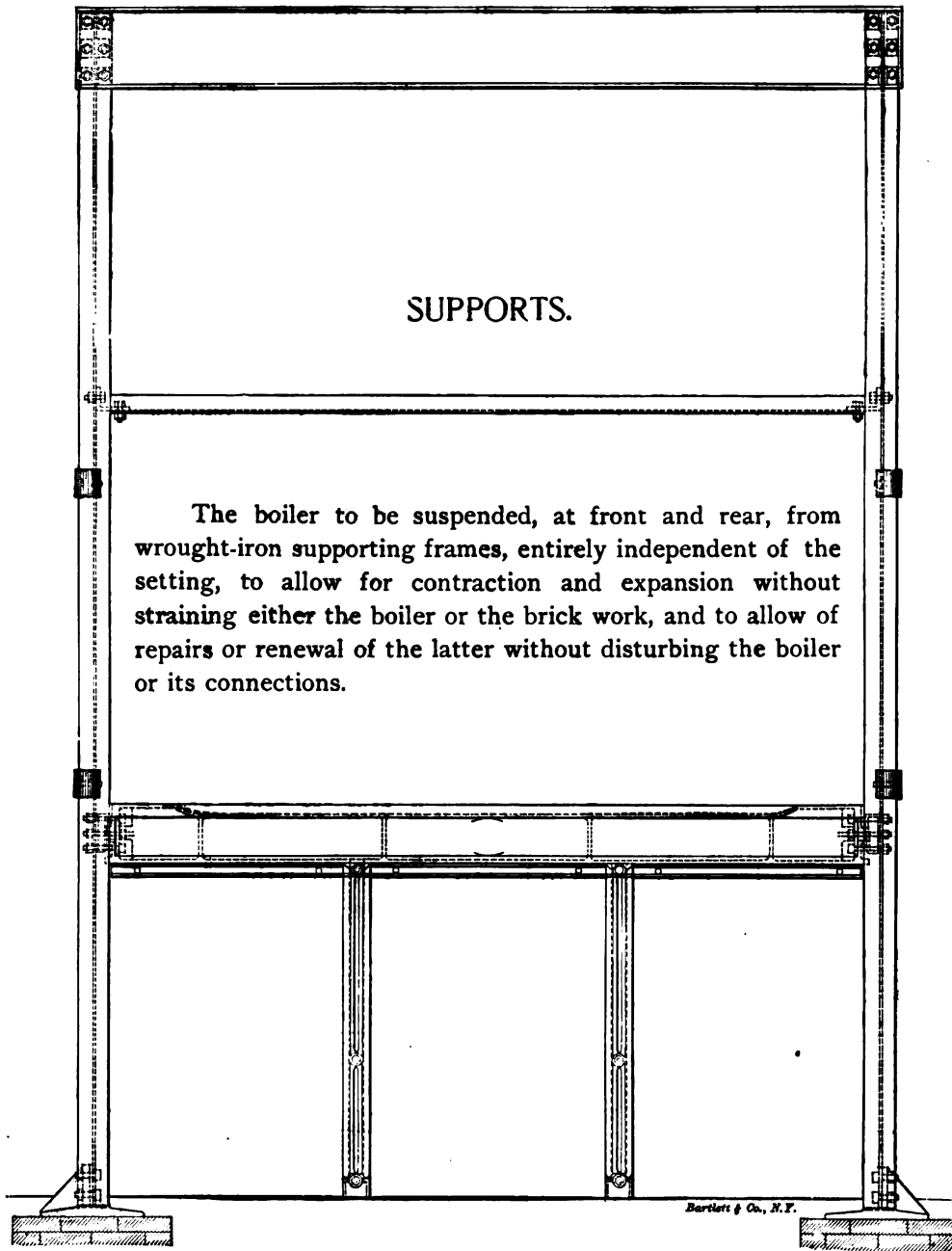

*Bartlett & Co., N.Y.*

## VALVES AND FITTINGS.

SAFETY VALVES.

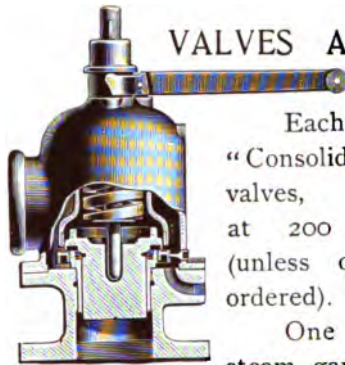

Each boiler to be provided with "Consolidated Co.'s" nickel seated safety valves, inches diameter, set to blow at 200 pounds (unless otherwise ordered).

STEAM GAUGE.

One Ashcroft steam gauge, with 12½-inch dial, and inside syphon, mounted in a heavy brass case.



One Ashcroft

STAND PIPE.

One stand pipe fitted with extra heavy bronze mountings for glass water gauge, with special shut-off device operated from fire room floor, to allow renewal of glass when under pressure.

WATER GAUGE.

TRY COCKS.



Three try cocks with lifting handles for operating from fire room floor, fitted with steam metal valves arranged for regrinding under pressure.



BLOW-OFF.

Independent blow-off pipes for bottom of column, and glass gauge; to be carried down the front, terminating with valves at height of hand.

COMBINATION STOP AND CHECK.



## FEED CONNECTIONS.

A combination stop and check valve of heavy bronze pattern, to be flanged directly to the drum head, operating automatically in case of rupture of feed piping.

STOP VALVE.  
CHECK VALVE.

One stop valve for feed,    inches diameter, and  
One check valve for feed,    inches diameter, to be  
placed hand high from boiler-room floor, connected by flanges,  
to allow of removal without disturbing main feed line.

BLOW-OFF.

Two    inch blow-off valves, with loose sleeve for blow-  
off pipe, for building into brick work, to allow for expansion  
and contraction.

CLEANING  
VALVES.

Two  $\frac{3}{4}$ -inch stop valves connected to steam and safety  
valve outlets, for cleaning hose connection.

PIPE AND  
FITTINGS.\*

Extra heavy brass pipe, and bronze fittings, to be used  
for connecting all the above mountings to the boiler. All  
angles in feed and stand pipe connections to be made with  
crosses and tees for cleaning.

### CROSS PIPES.

FOR DOUBLE DRUM BOILERS.

STEAM OUTLET

The steam drums to be connected by a balance pipe  
upon which the safety valves are to be mounted, and a cross  
pipe for steam valve.

Steam delivery outlet,    inches diameter,    inch flange.

### BOILER FRONT.

WROUGHT-IRON  
FRAME.

The front of the battery to be of an ornamental design,  
consisting of a heavy wrought-iron I and channel beam frame,  
fitted with large doors for access to the hand-hole plates  
and front headers.

FIRING  
FRONTS.

The fire fronts  
arranged to allow for  
expansion and con-  
traction. Independ-  
ent frames for fire  
doors bolted on, and  
ash doors fitted with  
blast catches.

All joints to be  
fitted and faces of  
doors planed.

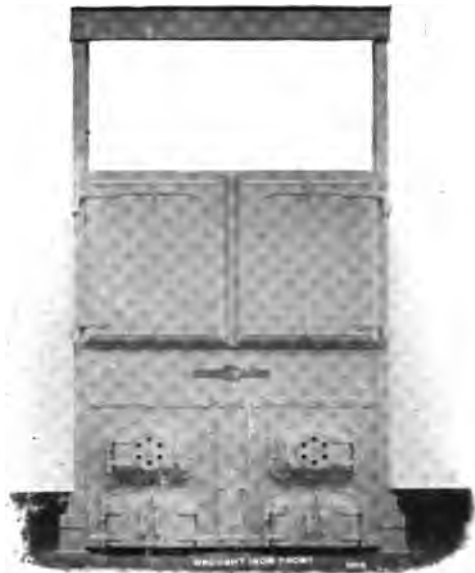

## FURNACE AND WALL FIXTURES.

FIRE-DOOR  
FITTINGS.

Dead plates and supports, the plates to be arranged for a fire-brick lining.

GRATES.

Fire-brick arches and jambs for fire-door openings.

FLAME  
BRIDGES.

A full set of grate bars and bearers, the latter to be fitted with expansion sockets for side wall.

Two sets of flame bridge plates with bolts and backing rings, and special fire-brick for lining the same.



BRIDGE WALL  
GIRDER.

One bridge wall girder for hanging bridge, fitted with expansion sockets for side wall.

CLEANING  
DOORS.

A full set of cleaning and ash doors for side walls, giving access to all parts for exterior cleaning.

DAMPER.

One swing damper and frame, with an auxiliary slide for closing tight when boiler is out of service.

BUCKSTAYS,  
ETC.

And the necessary buckstays, tie and anchor rods, anchor plates and lintels for securing all parts in position.

## TOOLS.

steel wrenches for hand-hole nuts.

Two tube scrapers, with handles.

One set of fire tools, consisting of poker, slice bar and hoe.

One set of best steam hose and cleaning pipe for blowing dust and soot from the exterior of tubes.

## MATERIAL AND WORKMANSHIP.

All materials to be of the best quality, each specially adapted to the service required, and the workmanship to be first-class in every particular.

## WORKING PRESSURE.

The boiler, as specified, will carry 200 pounds pressure, if desired.

## TESTING.

All pressure parts to be tested and made tight under hydrostatic pressure before leaving shop, as follows :

Sections, 400 pounds.

Drums, 300 pounds.

Mud-drums, 400 pounds.

When erected complete on foundations, the whole structure to be tested and made tight at 300 pounds pressure.

WEIGHT.

SPACE.

## WEIGHT, SPACE AND BRICK WORK.

Approximate shipping weight,                      pounds.

The space occupied by the battery, including brick work,    feet    inches long,    feet    inches wide,    feet    inches high to the top of steam flange.

BRICK WORK.

The brick work (to be provided by the purchaser), will require about

fire bricks and

red bricks,

Not including foundations or flues.



## ERECTING.

Full drawings and directions for erecting to be furnished, and services of man to do mechanical work and superintend erection, board and traveling expenses to be paid by purchaser, who is also to furnish the ordinary labor.

DELIVERY.

To be delivered f. o. b. New York.

TERMS.

Price as per accompanying letter.

One-half payable on presentation of sight draft with shipping receipt. Balance, sixty days from shipment. Foreign and mining shipments on presentation of bill of lading.

LIMIT.

This proposal will be void, unless accepted within thirty days.

DELIVERY

Deliveries subject to strikes, accidents or causes beyond our control.

THE BABCOCK & WILCOX CO.

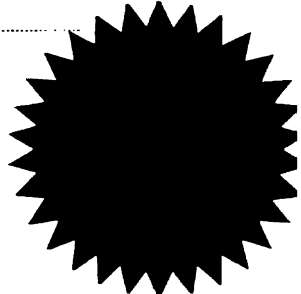

# THE BABCOCK & WILCOX CO.,

29 CORTLANDT STREET, NEW YORK, U. S. A.

## DIRECTORS:

NAT. W. PRATT, PRESIDENT

E. H. BENNETT, VICE-PRESIDENT.

F. G. BOURNE.

J. G. WARD, TREASURER.

CHAS. A. MILLER, SECRETARY

CHARLES A. KNIGHT

## BRANCH OFFICES:

BOSTON, MASS., U. S. A.:  
8 OLIVER STREET.  
PHILADELPHIA, PA., U. S. A.:  
32 N. FIFTH STREET.  
PITTSBURGH, PA., U. S. A.:  
1014 CARNEGIE BUILDING.  
CINCINNATI, O., U. S. A.:  
906 NEAVE BUILDING.  
ST. LOUIS, Mo., U. S. A.:  
817 SECURITY BUILDING.  
MONTREAL, CANADA:  
415 BOARD OF TRADE BUILDING.  
SAN FRANCISCO, CAL., U. S. A.:  
32 FIRST STREET.

CHICAGO, ILL., U. S. A.:  
910 MASONIC TEMPLE.  
MINNEAPOLIS, MINN., U. S. A.:  
604 CORN EXCHANGE.  
CLEVELAND, O., U. S. A.:  
CUVAHOGA BUILDING.  
NEW ORLEANS, LA., U. S. A.:  
339 CARONDELET STREET.  
HAVANA, CUBA:  
116½ CALLE DE LA HABANA  
ATLANTA, GA., U. S. A.:  
819 EQUITABLE BUILDING.  
BUFFALO, N. Y., U. S. A.:  
C. M. MORSE.

CABLE ADDRESSES: For New York, "GLOVEBOXES"; For Havana, "BABCOCK."

# BABCOCK & WILCOX, LIMITED,

147 QUEEN VICTORIA STREET, LONDON, E. C.

## DIRECTORS:

ANDREW STEWART, CHAIRMAN.

SIR WILLIAM ARROL.

ARTHUR T. SIMPSON, M.I.C.E., M.I.M.E.

I. G. MAIR RUMLEY, M.I.C.E., Mem. Council I.M.E.

CHAS. A. KNIGHT, MANAGING DIRECTOR.

JAMES H. ROSENTHAL, MGR., LONDON.

WALTER SHAW, SECRETARY.

## OFFICES:

LONDON, ENGLAND:  
147 QUEEN VICTORIA STREET.  
GLASGOW, SCOTLAND:  
21 BOTHWELL STREET.  
PARIS, FRANCE:  
15 RUE DE LA CHAUSSE D'ANTIN.

MILAN, ITALY:  
7 VIA DANTE.  
BRUSSELS, BELGIUM:  
68 BOULEVARD DU NORD.  
SYDNEY, N. S. W., AUSTRALIA:  
83 PITT STREET.

## REPRESENTATIVES:

BERLIN GERMANY:  
BERLINER MASCHINENBAU ACTIEN-GESELLSCHAFT. VORMALS L. SCHWARTZKOPFF.  
VIENNA, AUSTRIA:  
ERSTE BRUNNER MASCHINEN FABRIKS-GESELLSCHAFT.  
THE HAGUE, HOLLAND:  
W. SCHLUSEN.  
COPENHAGEN, DENMARK:  
C. H. D. ZAHRTMANN.  
CHRISTIANIA, NORWAY:  
A. L. THUNE, MECHANISK VAERKSTED.  
HELSINGFORS, FINLAND:  
FRITZ WILÉN.  
BARCELONA, SPAIN:  
ALFONSO FLAQUER.

FLORENCE, ITALY:  
A. EDLMANN.  
MEXICO, MEXICO:  
F. M. DE PREZ & Co.  
SAN JOSE, COSTA RICA, C. A.  
E. G. CHAMBERLAIN.  
BUENOS AYRES, ARGENTINE REPUBLIC:  
AGAR, CROSS & Co.  
COLOMBO, CEYLON:  
WALKER, SONS & Co., LTD.  
TIRHOOT, EAST INDIA:  
ARTHUR BUTLER.  
SOERABAYA, JAVA:  
J. GRUNDEL.  
JOHANNESBURG, TRANSVAAL, SOUTH AFRICA:  
REUNERT & LENZ.

CABLE ADDRESS: For London, Glasgow, Paris and Brussels, "BABCOCK."





89089673495



B89089673495A

UNIVERSITY OF WISCONSIN

JE 4 76

JE 4 76





89089673495



b89089673495a